

thermostats

4

bi-metal thermostats.....	208
sorted by producer.....	211
control thermostats with actual value display.....	270
remote thermostats.....	271
room thermostats.....	272
rod thermostats.....	272
refrigeration thermostats.....	273
miscellaneous.....	278
accessories.....	278



thermostats

NOTE
0.5A thermostats are only suited for gas or electronically controlled equipment!

bi-metal thermostats

safety bi-metal thermostats



fig.	vare nr.	HD (mm)	SOT (°C)	function	SC (A)	connection
1	390200	14	185	1NC	-	F6.3
1	375751	23.5	85	1NC	16	F6.3
1	375753	23.5	120	1NC	16	F6.3
2	390759	23.5	90	1NC	16	F6.3
3	390929	23.5	100	1NC	16	F6.3
3	390758	23.5	105	1NC	16	F6.3
3	390717	23.5	110	1NC	16	F6.3
3	375754	23.5	125	1NC	16	F6.3
3	390197	23.5	135	1NC	16	F6.3
3	390235	23.5	165	1NC	10	F6.3
4	390748	23.5	100	1NC	-	F6.3



fig.	vare nr.	HD (mm)	SOT (°C)	function	SC (A)	connection
5	390480	23.5	105	1NC	16	F6.3
6	390346	23.5	106	1NC	16	F6.3
7	390954	23.5	120	1NC	10	F6.3
8	375913	23.5	175	NC	16	F6.3



fig.	vare nr.	HD (mm)	SOT (°C)	function	SC (A)	connection
9	390708	23.5	180	1NC	16	M3
10	390222	23.8	112	1NC	-	F6.3
11	390394	24	130	1NC	16	F6.3
12	390410	24	200	1NC	16	F6.3
12	375493	28	230	1NC	16	F6.3



fig.	vare nr.	HD (mm)	SOT (°C)	function	SC (A)	connection
13	390199	24	210	1NC	16	F6.3
14	390879	31	120	2NC	15	F6.3
14	390456	40	85	2NC	16	F6.3
14	390455	40	100	2NC	16	F6.3
14	390681	40	105	2NC	16	F6.3
14	390624	40	125	2NC	16	F6.3
14	390531	40	150	2NC	16	F6.3
14	390187	40	180	2NC	16	F6.3
14	390367	39-44	130	2NC	16	F6.3
14	390852	39-44	135	2NC	16	F6.3
15	390466	45	62	1NC	16	F6.3
16	390916	-	68	1NC	16	F6.3
16	390461	-	95	1NC	10	F6.3
16	390233	-	110	1NC	16	F6.3
16	390974	-	130	1NC	16	F6.3
16	390379	-	150	1NC	16	F6.3
16	390380	-	155	1NC	16	F6.3
16	390369	-	175	1NC	16	F6.3



fig.	vare nr.	HD (mm)	SOT (°C)	function	SC (A)	connection
17	390026	-	70	1NC	16	F6.3
18	390462	-	105	1NC	16	F6.3
19	390171	-	110	1NC	16	F6.3
19	390684	-	120	NC	10	F6.3
20	390392	-	115	1NC	16	F6.3



fig.	vare nr.	HD (mm)	SOT (°C)	function	SC (A)	connection
21	390451	-	115	1NC	16	F6.3
22	390711	-	127	1NC	16	F6.3
23	390311	-	135	1NC	16	F6.3
23	375732	-	150	1NC	16	F6.3
24	390377	-	135	1NC	16	F6.3
24	390378	-	140	1NC	16	F6.3



fig.	vare nr.	HD (mm)	SOT (°C)	function	SC (A)	connection
25	390370	-	145	1NC	16	F6.3
25	390371	-	152	1NC	10	F6.3
25	390372	-	165	1NC	16	F6.3
25	390740	-	165	1NC	16	F6.3
26	376003	-	165	1NC	10	F6.3
27	390459	-	200	1NC	16	F6.3
27	375918	-	300	1NC	16	F6.3



fig.	vare nr.	HD (mm)	SOT (°C)	function	SC (A)	connection
5	390917	23.5	55	1NC	16	F6.3
5	390301	23.5	60	1NC	16	F6.3
5	390951	23.5	62.8	1NC	10	F6.3
5	390942	23.5	66	1NC	10	F4.8
5	390294	23.5	70	1NC	16	F6.3
5	390319	23.5	80	1NC	16	F6.3
5	390941	23.5	85	1NC	10	F4.8
5	375750	23.5	85	1NC	16	F6.3
5	390107	23.5	86	1NC	10	F6.3
5	390950	23.5	100	1NC	10	F6.3
5	390632	23.5	125	1NC	-	F6.3
5	390503	23.5	135	1NC	10	F6.3
5	390869	23.5	140	1NC	10	F4.8
5	390363	23.5	140	1NC	10	F6.3
5	390944	23.5	148.9	1NC	10	F6.3
5	390949	23.5	150	1NC	10	F6.3
5	390613	23.5	150	1NC	-	F6.3
5	390631	23.5	150	1NC	-	F6.3
5	390570	23.5	160	1NC	16	F6.3
5	390857	23.5	180	1NC	10	F4.8
5	390858	23.5	180	1NC	10	F4.8
5	390867	23.5	180	1NC	10	F4.8
5	390868	23.5	180	1NC	10	F4.8
6	390185	23.5	57	1NC	15	F6.3
7	390969	23.5	57.2	1NC	-	F6.3
8	390936	23.5	71	1NO	10	F6.3

bi-metal thermostats



fig.	vare nr.	HD (mm)	SOT (°C)	function	SC (A)	connection
1	390825	23.5	45	1NO	-	F6.3
2	375927	23.5	50	1NO	10	F6.3
2	390439	23.5	70	1NC	10	F6.3
2	390123	23.8	50	1NC	10	F6.3
3	390680	23.5	55	1NC	10	F6.3
3	390906	23.5	60	1NC	-	F6.3
3	390946	23.5	62.8	1NC	10	F6.3
3	390226	23.5	65	NC	16	F6.3
3	390705	23.5	80	1NC	16	F6.3
3	390940	23.5	81	1NC	10	F6.3
3	390504	23.5	90	1NO	10	F6.3
3	390945	23.5	110	1NC	10	F6.3
3	390947	23.5	110	1NC	10	F6.3
3	390937	23.5	113	1NC	10	F6.3
3	390633	23.5	125	NC	-	F6.3
3	390739	23.5	130	1NC	16	F6.3
3	390938	23.5	138	1NC	10	F6.3
3	390939	23.5	138	1NC	10	F6.3
3	390634	23.5	145	1NC	16	F6.3
3	390935	23.5	149	1NC	10	F6.3
3	390652	23.5	170	1NC	-	F6.3
3	390886	23.5	210	1NC	16	F6.3
4	390763	23.5	55	1NC	10	F6.3
4	390948	23.5	110	1NC	10	F6.3
4	390447	23.5	130	NC	10	F6.3
4	390859	23.5	140	1NC	10	F4.8



fig.	vare nr.	HD (mm)	SOT (°C)	function	SC (A)	connection
9	390955	23.5	73	1NC	10	F6.3
10	375749	23.5	75	1NC	16	F6.3
11	390615	23.5	-	1NO	16	F6.3
12	390635	24	150	NC	15	F6.3



fig.	vare nr.	HD (mm)	SOT (°C)	function	SC (A)	connection
13	390160	30	90	1NO	10	F6.3
14	375503	34	91	2NC	-	F6.3
15	390101	38	53	1CO	16	F6.3
15	390441	38	55	1NC	16	F6.3

Table continues overleaf



fig.	vare nr.	HD (mm)	SOT (°C)	function	SC (A)	connection
15	390231	40	55	1CO	16	F6.3
15	375737	40	80	1NC	16	F6.3
15	390614	40	100	1NC	16	F6.3
15	390909	46	130	1NC	16	F6.3
16	390468	40	60	1CO	16	F6.3
17	390102	40	85	1NC	16	F6.3
18	390347	40	115	1NC	16	F6.3



fig.	vare nr.	HD (mm)	SOT (°C)	function	SC (A)	connection
27	390436	-	100	1NC	16	F6.3
27	390364	-	155	1NC	16	F6.3
27	390365	-	165	1NC	16	F6.3
27	390727	-	180	1NC	-	F6.3
28	390627	-	110	1NC	-	F6.3
29	376002	-	120	1NC	10	F6.3
29	390533	-	160	1NC	16	F6.3
30	390361	-	120	1NC	10	F6.3



fig.	vare nr.	HD (mm)	SOT (°C)	function	SC (A)	connection
19	390025	40	55/42	NC/NO	16	F6.3
20	390103	-	59	1NC	16	F6.3
20	390925	-	65	1NC	16	F6.3
21	390483	-	65	1NO	16	F6.3
22	390511	-	78	1NC	10	F4.8
22	390104	-	95	1NC	16	F6.3
22	390350	-	110	1NC	16	F6.3
22	390354	-	135	1NC	10/16	F6.3



fig.	vare nr.	HD (mm)	SOT (°C)	function	SC (A)	connection
31	390359	-	160	1NC	16	F6.3
32	390390	-	200	2NC	16	F6.3
33	390850	-	250	1NC	10	F6.3
34	390096	-	250	1NC	16	F6.3



fig.	vare nr.	HD (mm)	SOT (°C)	function	SC (A)	connection
23	390320	-	90	1NC	16	F6.3
23	390128	-	95	1NC	16	F6.3
23	390322	-	100	1NC	16	F6.3
23	390697	-	103	1NC	10	F6.3
23	390152	-	107	1NC	16	F6.3
23	375160	-	110	1NC	16	F6.3
23	390963	-	120	1NC	10	F6.3
23	390129	-	125	1NC	16	F6.3
23	390326	-	130	1NC	16	F6.3
23	390153	-	135	1NC	16	F6.3
23	390323	-	145	1NC	16	F6.3
23	390327	-	150	1NC	16	F6.3
23	390329	-	165	1NC	16	F6.3
24	375242	-	92	1NC	16	F6.3
25	390397	-	95	1NC	10	F6.3
25	390351	-	120	1NC	16	F6.3
25	390355	-	140	1NC	16	F6.3
25	390356	-	145	1NC	16	F6.3
26	390413	-	100	1NC	10	F6.3



fig.	vare nr.	HD (mm)	SOT (°C)	function	SC (A)	connection
35	390747	-	270	1NC	-	F6.3
35	390746	-	318	1NC	13.5	F6.3
36	390428	-	-	1NO/1NC	15	F6.3
37	390450	-	66/57	NC/NO	16	F6.3

miscellaneous



fig.	vare nr.	SOT (°C)	function	SC (A)	volt. (V)	connection
1	390743	300	1CO	10	250	F6.3
2	374059	-	-	-	-	-
3	390866	-	1NO	-	-	F6.3



sorted by producer

EGO

control thermostats

51._ series

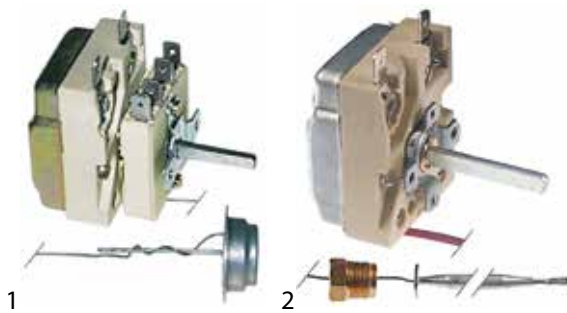

fig.	vare nr.	t.max. (°C)	t.range (°C)	NP (-pole)	function	SC (A)	probe ø (mm)	probe L (mm)	cap. (mm)	cap.ins. (mm)	gland nut	shaft L (mm)	suitable for	Ref. No.
1	390033	93	30-93	1	1NO	15	20/23.5	11	900	800	-	25	Angelo-Po EGO EGO	32Z0410 51.41918.500 55.13612.150
2	375593	110	85-110	1	1NO	15	6	265	2990	1700	-	35	EGO Küppersbusch	51.09995.010 174637

55.10/19_ series

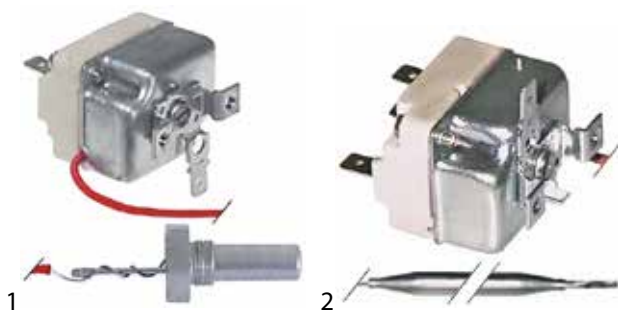

fig.	vare nr.	t.max. (°C)	t.range (°C)	NP (-pole)	function	SC (A)	probe ø (mm)	probe L (mm)	cap. (mm)	cap.ins. (mm)	gland nut	shaft L (mm)	suitable for	Ref. No.
1	390172	50	fixed 50	1	1CO	16	11	45	850	830	-	-	EGO EGO Elframo Komel	55.19302.810 55.19312.020 00057151 00057151
2	375219	55	fixed 55	1	1NO	16	6	130	900	850	-	-	EGO Lainox	55.19112.800 LAR65070100
2	390415	60	fixed 60	1	1CO	16	6	129	1470	1430	-	-	Adler EGO Electrolux	20110 55.19314.801 070311
2	375215	65	fixed 65	1	1CO	16	6	130	900	900	-	-	Angelo-Po EGO Lainox	32Z2430 55.19222.810 LAR65070165
2	375217	70	fixed 70	1	1CO	16	6	130	900	900	-	-	EGO Lainox	55.19222.811 LAR65070240
2	375113	76	fixed 76	1	1CO	16	3.1	226	870	870	-	-	EGO Electrolux	55.19312.801 056671
2	390416	85	fixed 85	1	1CO	16	6	129	1470	1430	-	-	Adler Bartscher EGO	20119 0481927128594 55.19314.800
2	375948	90	30-90	1	1CO	16	6	102	1000	960	-	-	EGO Mach	55.17219.020 500063900
2	375534	90	19-90	1	1CO	16	6	129	980	960	-	-	EGO Elframo Emmepi Komel	55.19219.825 22180004 809260 22180004

Table continues overleaf

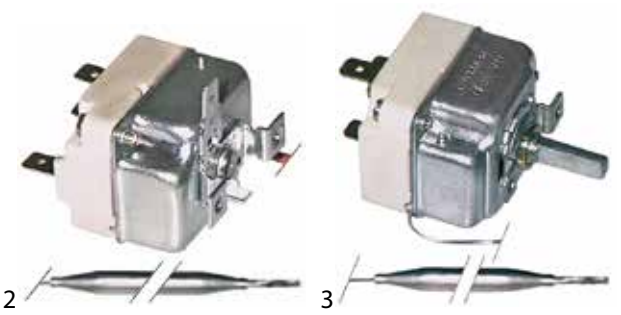



fig.	vare nr.	t.max. (°C)	t.range (°C)	NP (-pole)	function	SC (A)	probe ø (mm)	probe L (mm)	cap. (mm)	cap.ins. (mm)	gland nut	shaft L (mm)	suitable for	Ref. No.
2	375696	90	19-90	1	1CO	16	6	129	2970	2850	-	-	EGO	55.19216.010
2	375548	142	fixed 142	1	1CO	16	4	157	870	870	-	-	Ambach Baron EGO Kreff Mareno Silko	5061609772 CR0682740 55.19322.801 42-5061609772 CR0682740 CR0682740
2	375229	150	fixed 150	1	1CO	16	6	130	900	700	-	-	EGO Gico	55.19322.808 53400112150
2	375549	150	fixed 150	1	1NO	0.5	6	86	1000	-	-	-	Ambach EGO	5061603920 55.10129.827
2	375345	150	fixed 150	1	1NO	16	6	74	900	900	-	-	Angelo-Po EGO	32Z9380 55.19122.803
3	390824	60	fixed 60	1	1NO	16	6	134	1800	-	-	-	Morice	TH1123
3	375979	70	30-70	1	1NO	16	6	129	900	900	-	23	EGO Ilsa	55.19012.823 31482
3	375211	85	30-85	1	1CO	16	6	130	900	900	-	23	EGO Lasa Mareno	55.19212.802 3267320 1037314600
3	390307	86	30-82	1	1CO	16	3	156	600	600	-	8.5	EGO Kreff Palux	55.19219.821 62-236037 376035
3	390032	90	30-90	1	1CO	16	6	130	2500	-	M10x1	23	Angelo-Po EGO	32Z0160 55.19219.819
3	390040	90	30-90	1	1CO	16	6	130	2040	1940	-	23	Angelo-Po EGO EGO Electrolux Kelvin Mareno Olis Silko Teikos Zanussi	32V0200 55.19012.806 55.19219.810 003262 0101103 MA7800300 A046260 SIR0101403 843601 003262
3	390003	90	30-90	1	1CO	16	15	22.5	1700	-	-	16	Angelo-Po Bonnet EGO EGO Elettrobar	32Z0450 3650E 55.10219.820 55.19219.010 236002
3	375231	90	30-90	1	1NO	16	6	130	900	600	M9x1	18	EGO Lotus Rosinox	55.19012.801 537001500 RX94805249
3	375381	90	30-90	1	1NO	16	6	130	2000	2000	-	23	EGO EGO Emainox Olis	55.19019.806 55.19019.822 3700002 BN6A046050
3	375809	90	30-90	1	1NO	16	6	130	1800	1800	-	23	EGO Electrolux Juno Sogeco	55.19015.800 0K3061 0K3061 03-THR-090
3	375135	91	25-90	1	1CO	16	6	174	900	900	-	23	EGO EGO EGO Palux	55.10212.190 55.19212.800 55.19212.806 337609
3	375482	95	30-90	1	1CO	16	6	138	860	-	M9x1	23	Animo Bonnet EGO EGO	03090 1244788 55.10212.100 55.19212.020
3	376014	110	0-110	1	1NO	16	6	140	875	780	M9x1	23	Rosinox	RX94016615

Table continues overleaf



fig.	vare nr.	t.max. (°C)	t.range (°C)	NP (-pole)	function	SC (A)	probe ø (mm)	probe L (mm)	cap. (mm)	cap.ins. (mm)	gland nut	shaft L (mm)	suitable for	Ref. No.
3	375055	110	30-110	1	1CO	16	6	130	1500	-	-	23	Alpeninox EGO Electrolux Emmepi GIGA Silko Star10 Zanussi	0A2018 55.19224.801 0A2018 828838 X43100 SIR0101383 X43100 0A2018
3	375386	110	30-110	1	1NO	16	6	130	2000	2000	-	23	EGO Olis	55.19029.800 BN6A046105
3	375833	110	30-110	1	1NO	16	6	130	900	900	-	23	EGO	55.19022.804
3	375647	110	31-110	1	1NO	16	6	133	870	-	-	23	Bertos EGO Foinox Olis	25070800 55.19022.808 10005 BN6A046100
3	375238	110	33-110	1	1CO	16	6	138	880	870	-	23	EGO Gico	55.19222.809 53401030110
3	375001	112	30-110	1	1NO	16	6	130	900	-	M9x1	23	Ambach Bonnet CB EGO EGO EGO Haka MKN Modular Morice	5061602949 24650 09010015 55.10022.010 55.10022.910 55.19022.801 55.19022.819 9040 203498 66100400 TH1081
3	375568	140	50-140	1	1NO	0.5	6	107	860	-	-	23	EGO EGO Electrolux Juno	55.10022.340 55.19022.080 0H6126 0H6126
3	375363	150	60-150	1	1NO	16	3	144	1600	1600	-	23	Bertos EGO EKU Firex GIGA Lincar Offcar Olis	35301000 55.19029.806 4-FI-004 40100050 E10600 40000910 FX40100050 6A001414
3	375341	150	60-150	1	1NO	16	3	219	900	900	-	23	Bertos EGO Emmepi Silko	31290000 55.19022.813 809036 SIR0102492
3	375255	170	85-170	1	1NO	16	4	231	900	600	-	23	EGO EGO Tecnoinox	55.19032.803 55.19032.818 RC00038000
3	375387	170	85-170	1	1NO	16	4	231	900	850	M9x1	23	EGO Olis	55.19032.808 BN9000216
3	375606	171	85-171	1	1NO	16	6	133	870	700	-	23	Baron EGO	41826630370 55.19032.838
3	375488	175	45-170	1	1NO	16	3	219	900	900	-	23	EGO Electrolux Zanussi	55.19032.850 031480 031480
3	375718	180	70-180	1	1NO	16	6	87	1500	-	-	23	EGO Star10	55.19034.805 072001.1
3	375777	180	70-180	1	1NO	16	6	87	600	350	-	23	EGO Forved MBM-Italia Pieffe Saro	55.19039.815 3064 161791 0020 122-2002
3	375468	180	80-180	1	1NO	16	6	135	900	-	M9x1	23	Bonnet Capic EGO EGO	7471024 E401075 55.10032.207 55.19032.203
3	375309	180	95-180	1	1NO	16	6	130	1500	1100	-	23	EGO Electrolux OEM Tecnoinox	55.19034.800 006749 ED04800 RC00779000
3	375367	182	93-180	1	1NO	16	6	133	2020	1800	-	23	EGO Gico	55.19039.808 5340101
3	375395	182	95-180	1	1NO	16	6	133	870	-	M9x1	13	Angelo-Po EGO	32V4540 55.19032.813

Table continues overleaf

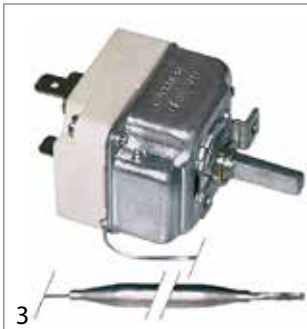

fig.	vare nr.	t.max. (°C)	t.range (°C)	NP (-pole)	function	SC (A)	probe ø (mm)	probe L (mm)	cap. (mm)	cap.ins. (mm)	gland nut	shaft L (mm)	suitable for	Ref. No.
3	375444	182	95-182	1	1NO	16	6	133	870	750	M9x1	23	Baron EGO EGO	BN41826630372 55.19032.070 55.19032.812
3	375720	184	80-184	1	1NO	16	6	87	570	-	-	23	EGO Star10	55.19039.816 072020.1
3	375310	185	100-185	1	1NO	16	4	231	1800	1600	M9x1	23	Ambach EGO	5061610987 55.19035.802
3	375856	185	105-185	1	1NO	16	6	130	900	700	M10x1	23	EGO VEGA	55.19032.831 93238
3	375922	187	101-185	1	1NO	16	6	133	870	520	M10x1	23	Angelo-Po EGO MBM-Italia	3168460 55.19032.100 173501
3	390053	188	90-185	1	1NO	16	4	231	1300	1300	-	23	EGO EGO Electrolux	55.10039.807 55.19039.800 050412
3	375237	190	100-190	1	1NO	16	6	130	1800	1200	M9x1	23	EGO GIGA Ilsa Star10	55.19035.800 Y16000 60775 Y16000
3	390046	190	104-190	1	1NO	16	6	133	870	-	M9x1	23	EGO EGO Electrolux Fimar Lotus Mareno	55.19032.040 55.19032.805 0KJ142 CO1111 537014300 MA1037035800
3	390779	190	105-190	1	1NO	0.5	4	235	1470	1250	M10x1	23	EGO EGO Elframo Repagas	55.19034.020 55.19034.070 22140004 64100014
3	375477	190	48-190	1	1NO	16	6	107	1470	-	M9x1	23	EGO Falcon	55.19034.040 731750711
3	375264	190	80-190	1	1NO	16	6	87	570	-	-	23	EGO Faba	55.19039.822 PR70009
3	375198	192	100-190	1	1NO	16	6	130	3000	2650	M9x1	23	EGO EGO EGO Mareno	55.10033.800 55.19036.800 55.19036.801 MA1981900
3	375639	192	100-192	1	1NO	16	4	235	870	-	-	21	EGO Olis	55.19032.807 A049100
3	375329	192	96-192	1	1NO	16	4	235	870	650	-	21	EGO	55.19032.840
3	390174	195	60-195	1	1NO	16	4	89	600	-	-	23	EGO Elframo Komel	55.19039.805 22140001 22140001
3	390731	195	65-195	1	1NO	16	4	106	1470	-	-	23	EGO Elframo Repagas	55.19034.060 22140002 8500014
3	375273	200	60-200	1	1NO	16	6	74	1500	-	-	23	Cuppone EGO Electrolux Moretti Pizza-Group	ME0000303 55.19034.802 0C6949 74220840 A88TX77002
3	390953	200	150-200	1	1NO	16	6	134	2250	2000	-	23	—	—
3	375004	211	35-200	1	1CO	16	6	74	1500	-	-	23	EGO EGO Foem	55.19234.800 55.19234.801 05000087150
3	375631	249	55-249	1	1NO	16	3.1	226	1270	850	3/8"-M8x1	23	Angelo-Po Convotherm EGO	32Z5820 5001032 55.19059.809
3	375719	250	48-250	1	1NO	16	3.03	160	1270	-	-	23	EGO Star10	55.19049.803 072032

Table continues overleaf



fig.	vare nr.	t.max. (°C)	t.range (°C)	NP (-pole)	function	SC (A)	probe ø (mm)	probe L (mm)	cap. (mm)	cap.ins. (mm)	gland nut	shaft L (mm)	suitable for	Ref. No.
3	375070	250	55-250	1	1CO	16	3.1	226	1170	1100	M9x1	23	EGO EGO Eloma Falcon Küppersbusch Palux	55.10243.010 55.19243.010 EL0091634 530091634 540522 091634
3	375462	250	55-250	1	1NO	16	3.1	226	2420	1100	-	23	EGO Eloma	55.19049.010 ELE334002
3	375336	255	45-255	1	1CO	16	6	74	900	900	-	23	CB EGO Emmepi	09010014 55.19252.807 C00545
3	390067	255	50-255	1	1NO	16	3	219	900	-	-	23	EGO EGO	55.10052.850 55.19052.803
3	390156	260	50-260	1	1NO	16	4	115	1300	1300	-	23	EGO Electrolux Juno Zanussi	55.19059.803 051360 051360 051360
3	375983	262	50-255	1	1NO	16	3	230	900	350	M10x1	23	EGO MBM-Italia	55.19052.897 RTFOC00698
3	375653	262	58-258	1	1NO	16	3	226	870	330	-	23	EGO	55.19052.817
3	375608	265	50-265	1	1NO	16	3	219	900	800	M9x1	23	EGO Inoxtrend	55.19052.832 C2190-00
3	390943	269		1	1NO	16	3	225	900	800	-	23	EGO Unox	55.19052.808 TR1100A0
3	375831	270	40-270	1	1NO	16	3	145	900	900	-	23	EGO Smeg	55.19052.837 818730033
3	375201	270	50-270	1	1CO	16	3	219	3000	2500	M10x1	23	EGO Mareno	55.19256.800 MA2992900
3	375354	270	50-270	1	1NO	16	3	219	900	900	-	23	EGO MBM-Italia	55.19052.846 RTCU600186
3	390815	273	57-273	1	1NO	16	3.1	226	1470	1250	M9x1	23	EGO Inoxtrend	55.19054.010 LC352
3	375216	280	50-280	1	1NO	16	3	228	1300	1150	-	23	Bertos EGO EGO Gico GIGA Lainox Mareno Modular	22061900 55.19043.850 55.19059.805 53401005270 X49600 LAR65070210 R65070210 66107300
3	390068	280	55-269	1	1CO	16	3.1	219	1280	1270	-	23	Angelo-Po Bertos EGO EGO Electrolux Foinox Gico GIGA Lainox Star10	32Z0610 23900600 55.19059.808 55.19259.811 057937 0596 53401005270 X43600 LAR50304031 X43600
3	375664	287	60-287	1	1NO	16	3.1	226	1470	350	-	23	Bonnet Capic EGO Electrolux Zanussi	301031 E401082 55.19054.801 054323 054323
3	375860	289	57-289	1	1NO	16	3.1	226	1780	1770	-	23	Coven EGO Sogeco	EMTS0300 55.19055.800 03-THR-270
3	375894	293	55-293	1	1NO	16	3.1	226	870	350	-	23	Cookmax EGO Unox	KTR009 55.19052.861 KTR009
3	375382	295	45-295	1	1NO	16	3	219	1300	350	-	23	Cookmax EGO Olis	A049200 55.19053.807 BN6A049200
3	375270	295	45-295	1	1NO	16	4	100	900	350	-	23	EGO EGO GIGA Lincar Lotus Offcar Olis Rosinox Silko Star10	55.19052.813 55.19052.843 X49800 40000906 40100042 FX40100042 40100042 RX94812577 SIR0101377 X49800

Table continues overleaf



3

fig.	vare nr.	t.max. (°C)	t.range (°C)	NP (-pole)	function	SC (A)	probe ø (mm)	probe L (mm)	cap. (mm)	cap.ins. (mm)	gland nut	shaft L (mm)	suitable for	Ref. No.
3	375823	296	50-275	1	1NO	16	3	133	900	900	-	43	EGO Smeg	55.19052.890 818731128
3	375667	296	65-296	1	1NO	16	3.1	226	980	980	-	23	EGO Electrolux Juno Lainox Zanussi	55.19059.831 056384 056384 LAR65070360 056384
3	375327	297	58-297	1	1NO	16	3.03	219	870	-	-	23	Anitec Bertos EGO Electrolux Star10 Tecnoinox	072005 23063600 55.19052.830 006941 072005 RC00769000
3	375184	298	55-294	1	1NO	16	3.1	226	870	350	-	23	Cookmax EGO Hobart Mareno Silko	1037102300 55.19052.812 144451108 MA1037102300 MA1037102300
3	375797	300	50-300	1	1NO	16	6	74	900	-	-	23	EGO GIGA Techfood	55.19052.825 Y19200 CE00091
3	375896	315	65-315	1	1NO	-	3.03	196	870	-	-	23	EGO	55.19052.819
3	375594	318	60-318	1	1NO	16	3.03	139	870	-	-	23	EGO Tecnoeka	55.19062.813 01200370
3	375824	320	50-320	1	1NO	16	3	145	900	900	-	23	EGO Smeg	55.19062.820 818730130
3	375723	320	50-320	1	1NO	16	3	219	900	700	-	23	EGO Indesit Star10	55.19062.806 C00066814 16001142401
3	376010	320	50-320	1	1NO	16	3	226	880	865	-	23	EGO Rosinox	55.19062.204 RX94024957
3	375002	320	55-320	1	1NO	16	3.1	226	870	850	-	23	Bartscher Bertos Bonnet Bourgeois CB Dihr EGO EGO EGO Electrolux Emmepi Faba Fimar Foinox Forved GIGA Kromo MBM-Italia Silanos Star10 Tecnoinox Zanolli Zanussi	A010401 22063600 7471032 THER001 09010021 DW9010 55.10062.010 55.19062.800 55.19062.802 004939 C00563 PR10009 CO1941 0026 GRILLTERMOS X68205 DW9010 RTCU700455 907130 X68205 RC00569000 ELET0013 004939
3	375553	320	57-320	1	1NO	16	3.1	226	870	870	-	15	Ambach EGO	5061618075 55.19062.845
3	375604	320	64-320	1	1NO	0.5	4	124	1470	-	-	23	Baron Cookmax EGO EGO Olis	41826630191 41826630191 55.10064.800 55.19064.020 BN826630191
3	375437	324	66-324	1	1NO	16	4	124	1470	-	-	23	Angelo-Po EGO Fimar	3220210 55.19064.800 CO1941

Table continues overleaf



fig.	vare nr.	t.max. (°C)	t.range (°C)	NP (-pole)	function	SC (A)	probe ø (mm)	probe L (mm)	cap. (mm)	cap.ins. (mm)	gland nut	shaft L (mm)	suitable for	Ref. No.
4														
5														
6														
7														
3	375799	325	55-325	1	1NO	16	3.03	120	600	-	-	23	EGO Tecnoeka	55.19069.858 01201230
3	376024	355	60-355	1	1NO	16	4	228	900	600	-	23	EGO Unox	55.19082.806 KTR1131A
3	375313	358	60-358	1	1NO	16	3.03	178	870	870	-	23	EGO Heidebrenner OEM	55.19072.802 94229 ED00700
3	375884	400	65-400	1	1NO	16	3.9	163	870	600	-	23	EGO Mareno	55.19082.812 MACM293801
3	375330	415	65-415	1	1NO	16	3.9	228	870	660	-	23	Anitec EGO Star10	072039 55.19072.805 072039
3	376004	422	65-422	1	1CO	16	4	230	900	630	-	23	EGO OEM	55.19272.801 ED05800
3	375253	450	85-450	1	1NO	16	3.9	228	870	660	-	23	CB Cookmax EGO Electrolux Faba Fornitalia GAM GMG Moretti Pizza-Group	09010027 74300110 55.19082.805 55.19082.808 004155 PR13012 40/60Z17 RG100417 PI-B148 74300110 A88TX77005
3	375945	470	90-470	1	1NO	16	3.9	163	870	600	-	23	Baron EGO Silko	CR0734520 55.19082.809 CR0734520
3	375661	500	75-500	1	1NO	16	3.9	228	1470	960	-	23	Alpeninox EGO Electrolux Moretti Zanussi	056701 55.19084.800 056701 74310830 056701
3	375247	500	75-500	1	1NO	16	4	228	900	-	-	23	Cuppone EGO Fage Fimar GGF Izmak	ME0000300 55.19082.802 EGO50092 CO3601 TERMO001 101001
4	390065	90	30-90	1	1CO	16	11	28	1000	1000	-	23	EGO Krefft Teikos	55.19219.815 62-236002 843621
4	375063	170	70-170	1	1NO	16	11	28	900	900	-	23	Bertos Bonnet EGO GIGA Silko	22064932 70707E 55.19032.825 0000X43300 SIR0109054
5	390924	90	30-90	1	1CO	16	20	12	1500	-	-	-	EGO Mach	55.19214.826 500070700
6	375321	90	35-90	1	1NO	16	11	24	900	900	-	23	EGO Modular	55.19012.814 66107000
7	375844	182	100-180	1	1NO	16	11	28	850	800	-	23	Angelo-Po EGO	32Z2940 55.19032.010



fig.	vare nr.	t.max. (°C)	t.range (°C)	NP (-pole)	function	SC (A)	probe ø (mm)	probe L (mm)	cap. (mm)	cap.ins. (mm)	gland nut	shaft L (mm)	suitable for	Ref. No.
8	375795	185	106-185	1	1NO	16	8	89	850	360	-	23	EGO	55.19032.816
9	376011	200	150-200	1	1NO	16	6	79	860	610	M9x1	23	EGO Rosinox	55.19039.202 RX94016680
10	375800	308	65-308	1	1NO	16	3.03	120	600	-	-	23	EGO Tecnoeka	55.19069.859 09952637000
10	375314	320	50-320	1	1NO	16	3	120	1200	-	-	23	Bonnet EGO EGO Indesit Lotus	2050031 55.19063.804 55.19069.831 C00089745 537019100

55.13_series

fig.	vare nr.	t.max. (°C)	t.range (°C)	NP (-pole)	function	SC (A)	probe ø (mm)	probe L (mm)	cap. (mm)	cap.ins. (mm)	gland nut	shaft L (mm)	suitable for	Ref. No.
1	375703	80	fixed 80	1	1NC	16	6	95	1470	1100	-	-	EGO Rieber	55.13114.020 33061505
1	390664	83	29-83	1	1CO	16	6	115	870	-	-	-	EGO Electrolux Zanussi	55.13212.640 0L2122 0L2122
1	390472	95	27-95	1	1NO	16	4	203	1230	800	-	-	EGO Hobart	55.13019.920 226505
2	375459	82	fixed 82	1	1CO	-	15/9	21	1000	950	-	-	EGO Fagor	55.13319.040 12024939
3	375727	85	20-85	1	1NO	16	4	124	870	790	-	15	EGO Hupfer	55.13012.900 014001214-02
3	375414	85	30-85	1	1CO	16	6	73	1540	1400	M9x1	23	EGO Fagor	55.13219.310 12024648
3	375006	85	30-85	1	1CO	16	6	92	3150	300	-	23	Bartscher Cookmax EGO EGO Electrolux Elettrobar GIGA Palux Zanussi	040575 040575 55.13212.410 55.13219.140 069422 236046 — 349313 069422
3	375145	85	30-85	1	1CO	16	6	113	2930	500/300	-	23	EGO Krefft	55.13216.020 602865
3	375005	85	30-85	1	1NO	16	6	92	830	-	-	23	EGO EKU Roka Roller Grill Wiesheu-Wiwa	55.13012.010 10-44 8900203 A06041 33003
3	375400	90	30-90	1	1CO	16	6	98	2380	1700	M9x1	18	EGO Fagor MKN Roller Grill	55.13219.440 12024096 203173 A06021

Table continues overleaf



fig.	vare nr.	t.max. (°C)	t.range (°C)	NP (-pole)	function	SC (A)	probe ø (mm)	probe L (mm)	cap. (mm)	cap.ins. (mm)	gland nut	shaft L (mm)	suitable for	Ref. No.
3	375085	90	0-90	1	1CO	16	3.1	247	1430	1400	-	18	EGO Krefft Küppersbusch Rational Rosinox	55.13214.160 76-30140312 407279 3014.0312 RX24848145
3	375130	90	32-90	1	1CO	16	6	129	710	500	-	23	EGO Fagor	55.13219.320 12024573
3	390862	90	71-90	1	1NO	16	3.1	201	900	120	-	25	EGO Falcon	55.13012.560 732920055
3	375712	91	30-91	1	1CO	16	3.1	201	1730	210	-	15	EGO Hupfer	55.13215.250 014001213
3	375304	93	28-93	1	1NO	16	3.1	244	710	650	-	23	EGO	55.13019.730
3	376018	93	28-93	1	1NO	16	3.1	244	710	650	-	23	Winterhalter	3125047
3	376026	93	30-93	1	1CO	16	6	90	1780	1870	M9x1	11	EGO	55.13215.050
3	375440	93	30-93	1	1CO	16	6	98	830	-	M9x1	23	EGO Lincat	55.13212.330 TH27
3	375526	93	31-93	1	1CO	16	6	98	2380	-	M9x1	23	EGO Jemi	55.13219.330 2006053
3	375837	96	31-96	1	1NO	16	6	94	980	-	-	23	EGO	55.13019.420
3	375566	96	82-96	1	1CO	16	6	147	870	-	M9x1	23	Corsair EGO Lincat	01-027 55.13212.370 TH09
3	375415	105	52-105	1	1CO	16	3.03	201	2380	2200	M9x1	23	EGO Fagor	55.13229.060 12018245
3	376046	110			NO	16	6	78	980	600	M9x1	27	Ambassade EGO	65224008 55.13022.750
3	375008	110	30-110	1	1CO	16	3.1	197	3150	300	-	23	EGO EGO Küppersbusch	55.13224.060 55.13229.030 174690
3	375136	110	30-110	1	1CO	16	6	113	870	-	-	23	EGO	55.13222.010
3	375871	110	30-110	1	1CO	16	6	113	2930	-	M9x1	23	EGO Electrolux Therma Zanussi	55.13226.030 0E5032 0E5032 0E5032
3	375007	110	30-110	1	1NO	16	6	113	870	-	M9x1	25	Ambassade CoffeeQueen EGO EGO EGO EGO Franke Giorik Hobart Lincar Roka Roller Grill Salvis	6528195 160214 55.13022.010 55.13022.020 55.13022.180 55.13022.390 178983 6010015 139866-48 40000901 8900202 A06044 178983
3	375567	110	30-110	1	1NO	16	6	115	1130	800	-	23	Blue Seal EGO EGO Electrolux Juno	— 55.13023.030 55.13024.050 OK0659 OK0659
3	375705	110	30-110	1	1NO	16	6	115	1430	-	M9x1	23	Ambassade Bartscher EGO Morice Scholl	6528193 06528193 55.13024.020 TH0117 70,10,02
3	375112	115	30-115	1	1NO	16	4	124	1730	800	-	15	EGO Hupfer	55.13025.040 014034027-01
3	375760	116	36-116	1	1NO	16	6	113	870	350	M9x1	23	EGO MKN	55.13022.370 203490
3	375744	120	30-120	1	1NO	16	6	85	2970	2950	-	18	EGO Mobile-Containing Scholl	55.13026.050 957050 70,10,30
3	390133	125	30-125	1	1CO	16	3.03	160	2290	1710	-	23	EGO Küppersbusch	55.13229.050 174690
3	375726	135	30-135	1	1NO	16	4	124	830	210	-	15	EGO Hupfer	55.13022.530 014040228-01
3	375952	150	30-150	1	1NO	16	6	84	850	-	-	23	EGO MKN	55.13022.110 203760

Table continues overleaf



fig.	vare nr.	t.max. (°C)	t.range (°C)	NP (-pole)	function	SC (A)	probe ø (mm)	probe L (mm)	cap. (mm)	cap.ins. (mm)	gland nut	shaft L (mm)	suitable for	Ref. No.
3	375788	175	101-175	1	1NO	16	6	98	870	800	-	23	Ambassade Bartscher EGO	6528195 021899 55.13032.370
3	375086	180	60-180	1	1CO	16	6	90	2400	2300	-	25	EGO Krefft Küppersbusch Rational	55.13239.020 76-30140314 407340 3014.0314
3	375401	185	97-185	1	1NO	16	6	87	1430	1100	M9x1	23	Bertos EGO EKU MKN Rosinox	33065600 55.13034.100 4-117 203662 RX24848269
3	390885	190	0-190	1	1NO	16	6	115	550	260	-	20	EGO Hendi	55.13039.340 205228
3	390910	190	130-190	1	1NO	-	6	117	890	-	M9x1	25	EGO Lincat Mirror	55.13032.260 TH29 XXEG5532543030
3	375517	190	60-190	1	1NO	16	6	77	870	-	-	23	Bartscher EGO	A039882 55.13032.400
3	375492	190	94-190	1	1NO	16	6	94	1090	960	M10x1	23	Baron Bartscher EGO Electrolux Emmepi Giorik Ilsa Lincat MBM-Italia Offcar Rosinox Silko Zanussi	85326010005 014231 55.13039.300 058163 808935 6010005 31229 40000907 RTBF800163 862115 RX94805371 SIR0108014 058163
3	375747	190	97-190	1	1NO	16	6	87	1430	1100	M9x1	23	EGO MKN	55.13034.120 203067
3	375677	195	100-195	1	1NO	16	4	157	2250	2020	-	18	EGO Falcon FriFri GIGA	55.13039.110 737400541 400541 FZ400541
3	375527	200	60-200	1	1NO	16	6	77	870	-	M9x1	23	EGO EGO FriFri	55.13032.010 55.13032.390 100374
3	375615	200	68-200	1	1NO	16	6	78	870	-	-	25	Bartscher EGO	0KG20509 55.13032.450
3	375204	215	60-215	1	1NO	16	3.1	201	870	600	M9x1	23	EGO Fagor	55.13042.290 12024623
3	375123	215	60-215	1	1NO	16	6	77	2250	2100	-	23	EGO Fagor	55.13039.120 12024662
3	375041	250	50-250	1	1CO	16	3.1	160	1430	800	M9x1	23	EGO Electrolux Juno	55.13244.010 0H6439 0H6439
3	375154	250	50-250	1	1NO	16	3.1	201	2970	-	-	23	Bourgeois EGO Wiesheu-Wiwa	THER019 55.13046.010 Sach.Nr.61902,36113
3	375010	250	50-250	1	1NO	16	3.1	208	1130	-	-	23	EGO EGO Küppersbusch MIWE Morice Whirlpool Wiesheu-Wiwa	55.13043.010 55.13043.060 174664 504024.16 TH0111 481227118033 34352
3	390884	250	50-250	1	1NO	16	6	62	1450	-	-	16	EGO Hendi	55.13044.050 923092

Table continues overleaf



fig.	vare nr.	t.max. (°C)	t.range (°C)	NP (-pole)	function	SC (A)	probe ø (mm)	probe L (mm)	cap. (mm)	cap.ins. (mm)	gland nut	shaft L (mm)	suitable for	Ref. No.
3	375069	255	50-255	1	1CO	16	3.03	160	1430	800	-	23	EGO Electrolux Juno	55.13254.030 OK0646 OK0634
3	375460	255	55-255	1	1NO	16	3.1	201	1170	1100	-	23	EGO Fagor	55.13043.060 12018390
3	375116	258	58-258	1	1NC	16	3.1	201	1130	-	-	23	Convotherm EGO	5001021K 55.13053.180
3	375087	300	50-300	1	1CO	16	3.03	160	1130	1103	-	23	Ambassade Bartscher EGO EGO Krefft Küppersbusch Rational	6553670 06553670 55.13062.140 55.13253.010 76-30140311 407276 3014.0311
3	375193	300	50-300	1	1NO	16	4	91	1130	1100	-	23	EGO MKN Palux	55.13053.140 203248 637718
3	375066	300	60-300	1	1CO	16	4	98	1450	-	-	25	EGO Krefft Rational	55.13254.040 76-30140166 3014.0166
3	375088	300	60-300	1	1NO	16	4	100	830	800	-	15	EGO Krefft Küppersbusch Rational	55.13052.150 76-30140318 407266 3014.0318
3	375128	310	50-310	1	1NO	16	3.03	160	1130	800	-	23	EGO Fagor	55.13063.160 12024549
3	375505	320	50-320	1	1NO	16	3	160	870	-	-	23	Anitec Ascobloc Bartscher Chergui Cooking-Systems Corsair EGO EGO EGO EKU Electrolux Falcon Foem Hendi Jemi Juno Küppersbusch Lotus Mareno MKN Palux Roller Grill RSI Star10 Therma Wiesheu-Wiwa	RG.A06042 8174681 030008099 03EDTH0020, EDTH002 2221 01-056 51.03915.020 55.13062.040 55.13069.500 15-BA-18 OH2049 539113110 03051500140 902011 2006061 OH2049 174681 537006100 MA643800 203500 202029 A06042 30008099 RG.A06042 OH2049 33073
3	375402	320	50-320	1	1NO	16	3.03	160	3150	-	-	23	EGO EGO EGO	55.13069.010 55.13069.040 55.13069.540
3	375612	324	54-324	1	1NO	16	3.03	147	1270	1180	-	23	EGO Küppersbusch	55.13069.140 161614
3	375012	358	50-358	1	1NO	16	3.1	147	1730	1100	-	23	EGO EGO Malag Ubert	55.13072.010 55.13075.010 143702 342229
3	375530	400	100-400	1	1NO	16	3.9	163	830	-	-	23	Bartscher EGO RSI VEGA	029154 55.13072.130 30008101 93044 G
3	375773	440	fixed 440	1	1NO	16	3.9	228	1130	850	-	-	EGO Küppersbusch	55.13183.020 161624

Table continues overleaf

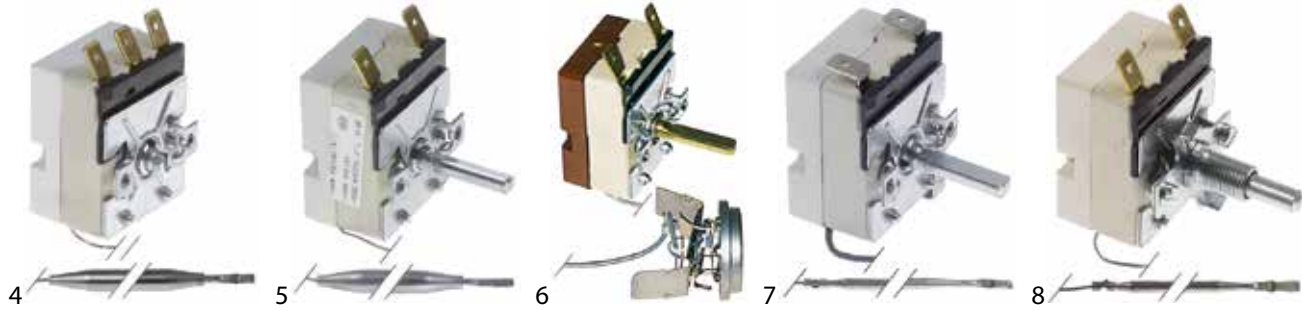

fig.	vare nr.	t.max. (°C)	t.range (°C)	NP (-pole)	function	SC (A)	probe ø (mm)	probe L (mm)	cap. (mm)	cap.ins. (mm)	gland nut	shaft L (mm)	suitable for	Ref. No.
4	390663	91	29-91	1	1CO	15	6	113	1470	-	-	-	EGO Electrolux Zanussi	55.13214.340 049243 049243
4	375954	109		1	1CO	16	3.03	198	900	610	M9x1	-	EGO Inoxtrend Lotus Whirlpool	55.13322.100 C2218-00 RRC2218-00 483286008707
4	390395	110	27-110	1	1NO	16	6	113	520	350	-	-	Bonamat EGO	6.016.005.018 55.13029.100
4	375710	132	fixed 132	1	1CO	16	6	86	1150	350	-	-	EGO Malag	55.13323.010 105767
5	390719	110	30-110	1	1NC	16	6	115	830	-	-	23	Bartscher EGO	A02030935 55.13022.050
6	390161	114	36-114	1	1NO	16	31/36	-	870	800	-	23	EGO MKN	55.13022.450 203167
7	390843	291	50-291	1	1NO	16	3	160	980	600	-	25	EGO Falcon	55.13059.180 731910500
8	390890	332	70-332	1	1NO	16	3	160	1470	-	-	26	EGO	55.13064.180

55.14_series

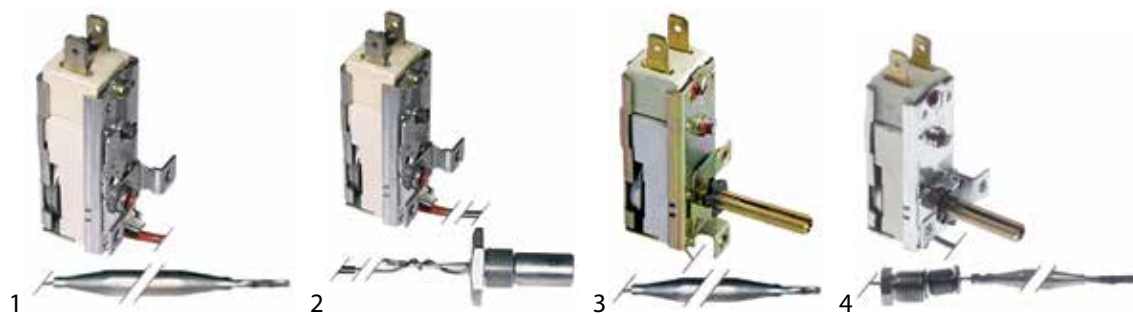

fig.	vare nr.	t.max. (°C)	t.range (°C)	NP (-pole)	function	SC (A)	probe ø (mm)	probe L (mm)	cap. (mm)	cap.ins. (mm)	gland nut	shaft L (mm)	shaft position	suitable for	Ref. No.
1	390316	53	fixed 53	1	1NC	16	6	116	600	600	-	-	-	EGO Elettrobar	55.14119.849 236024
2	390001	58	fixed 58	1	1NC	16	11	35	580	580	-	-	-	Bartscher Colged EGO GIGA Palux	0236023 DRT130B 55.14119.850 D236023 349305
3	375239	83	30-83	1	1NO	16	6	113	1480	700	-	25	upper	Blanco EGO	105795 55.14014.030
3	375716	95	30-95	1	1NO	10	6	113	1480	700	-	25	upper	Blanco EGO	105796 55.14014.040
3	375792	117	30-117	1	1NO	16	3.03	178	990	-	-	23	-	EGO	55.14029.090
3	375241	130	30-130	1	1NO	16	6	83	880	-	-	25	upper	Blanco EGO	105797 55.14022.120
3	375481	140	30-140	1	1NO	16	3	156	900	900	-	23	left	CPE EGO	55.14022.800 55.14022.800
4	375874	90	30-90	1	1NO	16	6	74	900	800	M10x1	23	-	Baron Cookmax EGO Mareno Silko	MA1037117700 1037117700 55.14012.800 MA1037117700 MA1037117700
4	375300	128	35-128	1	1NO	16	3.1	174	880	800	-	23	lower	EGO	55.14022.100



55.17_series

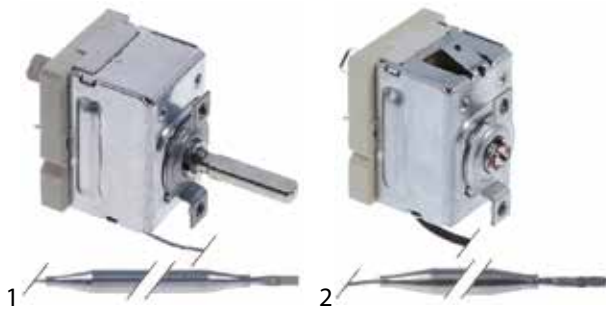

fig.	vare nr.	t.max. (°C)	t.range (°C)	NP (-pole)	function	SC (A)	probe ø (mm)	probe L (mm)	cap. (mm)	cap.ins. (mm)	gland nut	shaft L (mm)	shaft position	suitable for	Ref. No.
1	375674	85	30-85	1	1NO	16	6	94	840	-	-	23	upper	EGO Inoksan	55.17012.010 10100003
1	390236	110	30-110	1	1NO	16	6	83	840	-	-	23	upper	EGO	55.17022.030
1	375436	184	70-184	1	1CO	16	6	87	490	250	-	23	upper	Acopa Amitex EGO	10010 R00041 55.17039.030
1	375486	190	130-190	1	1NO	16	6	115	1300	-	-	23	-	EGO EGO	55.17039.010 55.17039.040
1	375349	250	50-250	1	1NO	16	3.03	178	840	-	-	23	upper	EGO Fiamma	55.17042.060 4.0.066.0114
1	375665	282	96-282	1	1NO	16	3.03	196	1240	350	-	22	left	EGO Electrolux Zanussi	55.17053.040 005207 005207
1	390853	287	57-287	1	1NO	16	3.1	122	1100	1050	-	23.5	right	EGO Garbin	55.17059.150 TER005
1	375933	295	62-295	1	1CO	16	3.03	152	1060	960	-	23	-	EGO Smeg	55.17059.310 818731124
1	390821	310	50-310	1	1NO	16	4	111	1000	-	-	16	-	EGO GMG	55.17069.120 KL-010
1	375672	320	50-320	1	1NO	16	3.03	178	840	-	-	23	upper	EGO Inoksan Rosinox	55.17062.140 10100004 RX94804655
2	390687	85	fixed 85	1	1CO	16	6	115	1500	1420	-	-	-	Adler EGO Electrolux	20596 55.17314.020 070350

55.18_series



pos.	vare nr.	t.max. (°C)	t.range (°C)	NP (-pole)	function	SC (A)	probe ø (mm)	probe L (mm)	cap. (mm)	cap.ins. (mm)	gland nut	shaft L (mm)	suitable for	Ref. No.
1	375715	85	35-85	1	1NO	16	6	113	2020	500	-	15	Blanco EGO	105899 55.18019.130
2	375729	95	34-95	1	1NO	16	6	113	1470	-	-	25	Blanco EGO	359583 55.18014.020
3	390899	110	9-110	1	1NO	16	6	94	870	-	-	15	EGO	55.18022.060
4	375714	116	35-116	1	1NO	16	6	113	1770	500	-	15	Blanco EGO	105883 55.18025.010
5	390703	120	32-110	1	1NO	16	6	110	870	-	M9x1	25	EGO Falcon Lincat	55.18022.010 539113130 TH34
6	390769	130	35-130	1	1NO	16	6	113	900	500	-	17	Blanco EGO	00105900 55.18022.040

Table continues overleaf



pos.	vare nr.	t.max. (°C)	t.range (°C)	NP (-pole)	function	SC (A)	probe ø (mm)	probe L (mm)	cap. (mm)	cap.ins. (mm)	gland nut	shaft L (mm)	suitable for	Ref. No.
7	375110	190	121-190	1	1NC	16	6	117	390	-	-	15	Bartscher EGO Olis	A010502 55.18031.010 6A010502
8	390831	190	130-190	1	1NO	16	6	113	870	-	M9x1	25	EGO Falcon Falcon Lincat	55.18032.040 731300190 731320106 TH59
9	375989	190	130-190	1	1NO	16	6	118	890	-	-	23	Corsair EGO Lincat Parry Valentine	42-045 55.18032.020 TH69 — —
10	375485	190	130-190	1	NO	16	6	119	400	190	-	23	EGO Lincat	55.18031.040 TH82
11	375483	320	50-320	1	NO	16	3	158	870	-	-	23	Ascobloc EGO Lincat Parry	09/1687 55.18062.050 TH12 —

55.22_series



fig.	vare nr.	t.max. (°C)	t.range (°C)	NP (-pole)	function	SC (A)	probe ø (mm)	probe L (mm)	cap. (mm)	cap.ins. (mm)	gland nut	shaft L (mm)	suitable for	Ref. No.
1	375080	102	30-90 / 50-102	2	2CO	16	3.1	334	1440	1400	-	23	EGO Electrolux Juno	55.22214.010 0H6242 0H6242



55.34_series

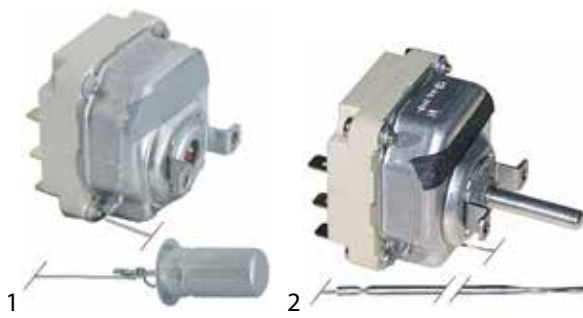

fig.	vare nr.	t.max. (°C)	t.range (°C)	NP (-pole)	function	SC (A)	probe ø (mm)	probe L (mm)	cap. (mm)	cap.ins. (mm)	gland nut	shaft L (mm)	suitable for	Ref. No.
1	375144	52	fixed 45/52	2	2CO	16	15	22.5	2280	-	-	-	EGO Krefft	55.34319.050 602959
2	375161	85	15-60/15-85	2	2CO	16	6	113	2980	300/300	-	23	EGO Krefft	55.34216.030 602715
2	375019	85	30-85	3	3NO	16	6	131	1440	-	M9x1	23	Capic EGO Stahl Thielmann Ubert	E401011 55.34014.150 162015 144180 342217
2	390042	85	35-85	3	3CO	16	9.5	80	870	-	-	23	EGO Elframo Komel	55.34212.828 22190001 22190001
2	375901	90	30-90	3	3NO	16	6	131	870	820	-	23	EGO	55.34012.800
2	375210	90	38-90	3	3CO	16	6	215	900	900	-	-	EGO Electrolux Lasa Mareno Zanussi	55.34212.801 049191 3267240 1037304900 049191
2	375212	93	30-93	2	2NO	16	6	173	1780	-	M9x1	23	EGO	55.34015.010
2	375305	93	30-93	3	3CO	16	6	175	870	-	M9x1	23	EGO	55.34212.030
2	375174	93	30-93	3	3CO	16	6	235	880	700	M9x1	23	EGO Palux	55.34212.090 006955
2	375411	93	30-93	3	3NO	16	6	129	1480	1100	M10x1	23	Angelo-Po EGO EGO EGO EGO Electrolux Foem Gico Juno Lotus Mareno MBM-Italia Olis Sagi Silko Zanussi	32z0130 55.34012.801 55.34012.859 55.34014.190 55.34019.805 6301018190 052000 05000087250 53403003090 052000 537000800 MA1037035015 160561 BN6A046250 32Z0130 MA1037035015 052000
2	375640	110	1x20-90/2x40-110	3	2NO/1NO	16	6	130	900	900	-	23	EGO Olis	55.34022.809 BN6A046240
2	375814	110	30-110	3	3NO	16	6	130	1200	1200	-	23	EGO	55.34023.801
2	375188	110	30-110	3	3NO	16	6	131	1160	-	-	23	EGO EGO Malag Mareno	55.34023.050 55.34024.805 105813 CR0500540
2	375630	110	30-110	3	3NO	16	6	131	900	-	M9x1	23	EGO Tecnoinox	55.34022.802 RC00001207
2	375671	110	30-110	3	3NO	16	6	131	1200	600	-	23	EGO Electrolux Zanussi	55.34023.815 0A2237 0A2237
2	375021	110	32-110	3	3CO	16	6	138	2980	2200	M9x1	23	EGO EGO Emmepi MKN Palux Repagas Rosinox Silko Stierlen	55.34029.080 55.34226.040 808058 203486 291706 22405003 RX94805421 SIR0108112 02100304

Table continues overleaf

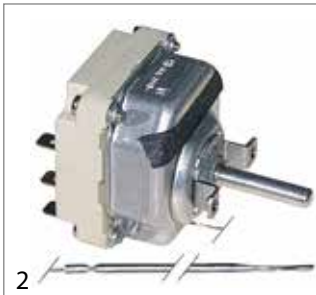

fig.	vare nr.	t.max. (°C)	t.range (°C)	NP (-pole)	function	SC (A)	probe ø (mm)	probe L (mm)	cap. (mm)	cap.ins. (mm)	gland nut	shaft L (mm)	suitable for	Ref. No.
2	375143	110	32-110	3	3NO	16	6	138	1480	1100	M9x1	23	Alpeninox Ambach Blumauer Bonnet Capic CoffeeQueen EGO EGO EGO EGO Electrolux Gastrofrit Haka Juno King Lotus MKN Modular Morice Palux Scholl Silko Solymac Stahl Tecnoinox Zanussi	0A2237 5061608152 180705 7492058 E401015 160215 55.34022.130 55.34022.160 55.34022.810 55.34024.060 55.34025.060 004911 306025.007 9041 004911 004911 537012300 203491 66100500 TH1084 290319 70,10,05 SIR0101388 P76 162020 RC00274000 004911
2	375602	120	45-120	3	3CO	16	6	140	900	870	-	23	Baron EGO Giorik Lincar	BN4185326010016 55.34222.807 6010016 40000908
2	375887	125	65-125	3	3NO	16	6	77	880	880	-	23	Baron Cookmax EGO Olis	BN6A044650 6A044650 55.34022.813 BN6A044650
2	390979	129	34-129	3	3NO	16	6	140	2260	120	-	23	EGO Öztiryakiler	55.34029.010 6234.00001.37
2	375256	175	100-175	3	3NO	16	4	157	850	350	-	23	EGO FriFri Tecnoinox	55.34039.080 400369 RC00064000
2	390058	175	100-175	3	3NO	16	6	131	2000	600	-	23	EGO Electrolux	55.34039.837 0A2003
2	375385	180	100-180	3	3NO	16	6	131	2000	1800	-	23	Bartscher Bertos Bonnet Cookmax EGO Mareno Olis	023964 33066200 301062 8219601 55.34039.800 BN8219601 BN8219601
2	375735	180	100-180	3	3NO	16	6	133	2300	450	M9x1	23	EGO Imperial-Germany MKN	55.34039.030 8018402 203661
2	375699	180	90-180	3	3CO	16	6	133	880	800	-	23	EGO Electrolux	55.34232.010 0K9907

Table continues overleaf



fig.	vare nr.	t.max. (°C)	t.range (°C)	NP (-pole)	function	SC (A)	probe ø (mm)	probe L (mm)	cap. (mm)	cap.ins. (mm)	gland nut	shaft L (mm)	suitable for	Ref. No.
2	375022	180	95-180	3	3NO	16	6	133	1780	1400	M9x1	23	Ambach Bonnet EGO EGO Electrolux GIGA Haka Juno MKN Scholl Therma Thirode Ubert	5061608750 301062 55.34032.813 55.34034.150 55.34035.080 0H6127 AEC002ZR10 9042 0H6127 203497 70,10,04 0H6127 301062 342206
2	375410	180	95-180	3	3NO	16	6	133	1780	1400	M10x1	23	EGO EGO EKU Emmepi Foem Mareno	55.34032.390 55.34035.130 4-103 807603 05050033650 MA1037101400
2	375049	180	99-180	3	3NO	16	7	175	880	-	-	23	EGO	55.34032.320
2	390056	185	100-185		3NO	16	4	231	2600	1000	-	23	EGO Electrolux Tecnoinox	55.34039.807 004925 RC00281000
2	375839	185	60-185	3	3NC	16	4	229	2600	1000	-	23	EGO Electrolux Zanussi	55.34039.856 051361 051361
2	376400	185	60-185	3	3NO		3	235	1180	1060	M9x1	24	EGO Electrolux	55.34033.020 0G2760
2	375576	185	60-185	3	3NO	16	4	229	1200	1150	-	23	EGO Electrolux	55.34033.801 005940
2	375058	185	95-185	3	3NO	16	6	117	1480	800	-	23	EGO Palux	55.34034.010 178144
2	375512	185	95-185	3	3NO	16	6	133	2430	1100	M9x1	23	EGO EGO FriFri MKN Roka	55.34034.110 55.34039.020 400370 203487 8900210
2	375708	188	95-188	3	3NO	16	6	117	1780	1400	-	23	EGO Küppersbusch Thielmann	55.34035.110 540444 143766
2	375821	190	100-190	3	3NO	16	6	133	530	500	-	23	Gastrofrit	306025.006
2	376005	190	100-190	3	3NO	16	6	133	530	500	-	23	EGO	55.34039.100
2	375771	190	106-190	3	1CO/2NO	16	4	157	1780	1500	-	23	EGO Valentine	55.34235.040 6310-SA
2	375766	190	120-190	3	1CO/2NO	16	6	133	880	350	-	23	EGO Electrolux Therma Valentine	55.34232.030 002587 002587 3201-02
2	375428	190	130-190	3	3NO	16	6	219	880	-	-	23	EGO Falcon Lincat	55.34032.300 539215840 TH24
2	375435	190	56-190	3	3NO	16	6	130	900	670	M10x1	23	EGO Emmepi Giorik	55.34032.863 807603 6010004
2	375396	190	95-190	3	3NO	16	6	133	1480	-	-	23	EGO Electrolux Parry	55.34034.170 0K3092 nml —
2	375417	191	68-191	3	3NO	16	6	79	840	-	M9x1	23	Capic EGO Hobart Morice Roller Grill Rosinox	— 55.34032.060 49360008 TH1079 A06005 RX24845588
2	390057	192	100-192	3	3NO	16	7	200	870	-	-	23	EGO Elframo Komel	55.34032.800 22160001 22160001

Table continues overleaf

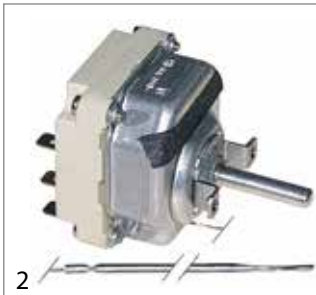

fig.	vare nr.	t.max. (°C)	t.range (°C)	NP (-pole)	function	SC (A)	probe ø (mm)	probe L (mm)	cap. (mm)	cap.ins. (mm)	gland nut	shaft L (mm)	suitable for	Ref. No.
2	375097	195	95-195	3	3NO	16	6	117	1780	1400	M9x1	23	Bertos EGO EGO EGO GIGA X43800 Krefft Küppersbusch MKN Modular Nayati Rosinox Silko Star10	22062900 55.34034.801 55.34035.010 55.34035.090 X43800 49-355637 355637 203497 66104100 GS2228 RX94804978 SIR0109055 X43800
2	375050	200	60-200	3	3NO	16	3.1	235	1480	-	-	23	EGO FriFri	55.34034.210 100374
2	390059	200	60-200	3	3NO	16	6	77	880	-	-	23	EGO	55.34032.030
2	375060	200	60-200	3	3NO	16	6	142	880	-	-	23	EGO	55.34032.010
2	375043	200	68-200	3	3NO	16	6	77	880	800	M9x1	23	Capic EGO EGO EGO Electrolux FriFri Juno Morice	E401045 55.34032.160 55.34032.430 97.55340.423 0H6221 09580111 0H6221 TH1079
2	376009	200	68-200	3	3NO	16	6	79	2390	1600	M9x1	23	EGO Rosinox	55.34039.050 RX94016698
2	375687	205	95-205	3	3CO	16	6	224	1480	1100	-	23	EGO EGO Malag	53.12955.010 55.34244.030 105792
2	375763	206	120-206	3	1CO/2NO	16	4	157	1780	1500	-	23	EGO Electrolux Therma Valentine	55.34235.020 OKL450 OKW841 6311-SA
2	375422	210	95-210	3	3NO	16	3.1	226	1780	1600	-	23	Ascobloc EGO Küppersbusch	8152105 55.34035.100 152105
2	375301	220	60-220	3	3NO	16	6	77	880	-	-	23	EGO	55.34032.110
2	375504	220	95-220	3	3NO	16	6	117	1480	1100	-	23	EGO MKN	55.34044.020 203499
2	375559	230	95-230	3	3NO	16	4	128	1250	1000	-	23	EGO Electrolux Mareno Modular Silko Zanussi	55.34043.800 0C7528 CR0686120 66112300 CR0686120 002402
2	375272	240	55-240	3	3NO	16	4	91	880	350	-	23	EGO Silko	55.34042.805 SIR0101424
2	375693	250	48-250	3	3NO	16	3.1	226	880	850	-	23	EGO Roka	55.34042.170 8900211
2	375813	260	100-260	3	3NO	16	6	75	1150	1150	-	23	EGO	55.34059.807
2	390800	270	0-270	3	3NO	-	6	75	2400	-	-	23	Bourgeois EGO	THER017 55.34059.090
2	375230	270	55-270	3	3NO	16	3	219	900	900	-	23	EGO Gico	55.34052.831 53403050390
2	375384	275	50-275	3	3NO	16	3	219	900	900	-	23	Casta EGO Olis	08/85900009 55.34052.809 BN6A044601
2	375470	278	71-278	3	3NO	16	6	75	1180	1100	-	23	Bertos EGO	30064900 55.34059.814

Table continues overleaf



fig.	vare nr.	t.max. (°C)	t.range (°C)	NP (-pole)	function	SC (A)	probe ø (mm)	probe L (mm)	cap. (mm)	cap.ins. (mm)	gland nut	shaft L (mm)	suitable for	Ref. No.
2	375587	285	100-285	3	3NO	16	3	219	1150	1130	-	23	EGO Electrolux MBM-Italia Zanussi	55.34059.801 059235 164332 059235
2	375268	295	75-295	3	3NO	16	4	92	900	350	-	23	EGO Rosinox Silko	55.34052.811 RX94812621 SIR0101373
2	375183	298	50-298	3	3NO	16	3	219	900	-	-	23	EGO Electrolux Mareno Tecnoinox	55.34052.817 004917 MA1037100600 RC00285000
2	375025	300	50-300	3	3CO	16	6	77	2980	2260	-	23	EGO EGO MKN	55.34059.060 55.34256.020 203488
2	375192	300	50-300	3	3NO	16	3	219	900	-	-	23	Baron Cookmax EGO EGO Lincar Mareno Modular Rosinox Silko	MA1309115 1309115 55.34052.815 55.34052.819 40000905 MA1309115 66102700 RX94805645 MA1309115
2	375355	300	50-300	3	3NO	16	3	219	900	900	-	23	EGO MBM-Italia	55.34052.812 RTC0600067
2	375603	300	50-300	3	3NO	16	3	219	900	900	-	23	Baron Cookmax EGO Gico	41826630123 41826630123 55.34052.807 53403000350
2	375685	300	50-300	3	3NO	16	3.1	226	1180	500	-	23	EGO Malag	55.34053.050 105784
2	375552	300	50-300	3	3NO	16	4	229	900	900	-	23	Ambach EGO	5061618784 55.34062.826
2	375056	300	50-300	3	3NO	16	4	292	1440	-	-	23	EGO	55.34054.060
2	375390	300	50-300	3	3NO	16	4	292	880	800	-	23	EGO MKN Palux	55.34052.060 203565 723231
2	375038	300	50-300	3	3NO	16	6	79	1740	800	-	23	Angelo-Po Anitec Ascobloc Bertos Blumauer Bonnet Bourgeois Capic EGO EGO EGO EGO Electrolux GIGA Haka Imperial-Germany Juno King Miele MKN Morice Öztiryakiler Repagas Rosinox Solymac Star10 Therma Thielmann Zanussi	3222560 X43900 09/3458 22062600 183305 301005 THER007 E401060 55.34052.270 55.34054.050 55.34055.020 55.34059.804 0H6217 X43900 9044 18882 0H6217 0H6217 08018882 203494 TH1086 6234.00001.14 32104009 RX94032588 P79 X43900 0H6217 139783 0H6217
2	375569	300	60-300	3	3NO	16	3.1	263	1180	800	-	23	EGO Electrolux Juno	55.34053.030 0H6218 0H6218
2	375057	300	60-300	3	3NO	16	4	128	880	800	-	23	EGO Palux	55.34052.020 224081
2	375560	300	115-300	3	3NO	10	3	144	1150	1130	-	23	EGO Electrolux	55.34059.812 004363
2	375453	308	100-300	3	3NO	16	6	75	1150	-	-	23	EGO	55.34059.806
2	375420	320	110-320	3	3NO	16	6	96	1780	1600	-	23	EGO Electrolux Juno	55.34065.020 0H6216 0H6216

Table continues overleaf

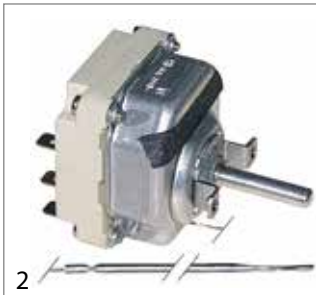

fig.	vare nr.	t.max. (°C)	t.range (°C)	NP (-pole)	function	SC (A)	probe ø (mm)	probe L (mm)	cap. (mm)	cap.ins. (mm)	gland nut	shaft L (mm)	suitable for	Ref. No.
2	375621	320	50-320	3	3NO	16	3	219	1200	1200	-	23	EGO Electrolux Lotus Therma	55.34063.811 OK8421 537000900 OK8421
2	375412	320	50-320	3	3NO	16	3.1	226	1480	1400	-	23	Alpeninox EGO Electrolux Foem Gico Juno Lotus Mareno Olis Silko Zanussi	0A2206 55.34064.030 0A2206 05000087350 53403050300 0A2206 537013500 MA1732000 BN6A044600 SIR0101384 0A2206
2	375362	320	55-320	3	3NO	10	4	128	900	-	-	23	EGO Giorik Ilsa Offcar	55.34062.819 5910028 843735 843735
2	375424	320	60-320	3	3NO	16	4	128	1800	1300	-	23	EGO Electrolux Inoksan	55.34069.804 052099 10100005
2	375614	330	100-330	3	3NO	16	6	75	870	870	-	23	EGO Modular	55.34062.803 66100700
2	375383	350	100-350	3	3NO	16	6	75	870	-	-	23	EGO Lincat Olis	55.34062.010 TH39 6A044900
2	375026	350	100-350	3	3NO	16	6	77	2430	1100	-	23	Bonnet Charvet EGO EGO EGO EGO MKN Morice Palux Solymac Thirode	7471044 01999a 55.34062.030 55.34064.010 55.34065.010 55.34069.030 203406 TH1088 291730 P80 301006
2	375944	350	100-350	3	3NO	-	3	147	900	-	-	26	Baron EGO Mareno Modular Silko	CR0582770 55.34062.160 CR0582770 66111600 CR0582770
2	375107	350	60-350	3	3NO	16	4	128	880	800	-	23	EGO	55.34062.150
2	375565	350	fixed 350	3	3NC	16	3	190	900	900	-	-	EGO Electrolux Zanussi	55.34162.800 0C0270 0C0270
2	375101	360	140-360	3	3NO	16	4	292	990	500	-	23	EGO Eloma Malag Palux	55.34079.050 ELE334008 105849 126543
2	375225	400	91-400	3	3NO	16	3.9	308	920	800	-	23	EGO Malag	55.34079.010 105847
2	375027	470	50-470	3	3NO	16	3.9	308	990	800	-	23	EGO Fage Inoksan	55.34089.010 EGO500 10100002
2	375132	500	50-500	3	3NO	16	4	228	1200	-	-	23	EGO Fage GGF	55.34093.800 EGO500 thermo003
2	375498	512	60-512	3	3NO	16	3.8	225	1150	1110	-	32	EGO GGF Moretti	55.34083.803 TERMO002 74200140

Table continues overleaf



fig.	vare nr.	t.max. (°C)	t.range (°C)	NP (-pole)	function	SC (A)	probe ø (mm)	probe L (mm)	cap. (mm)	cap.ins. (mm)	gland nut	shaft L (mm)	suitable for	Ref. No.
3	390038	90	30-90	3	3CO	16	6	215	900	-	-	-	Bonnet EGO Electrolux Juno Morice Therma	5004E 55.34212.814 OKI260 OKI260 DE1237 OKI260
3	375018	90	fixed 55/90	2	2CO	16	6	175	360	210	-	-	EGO Palux	55.34311.020 277096
3	375697	120	fixed 120	2	2CO	16	3.1	305	720	600	-	-	EGO Küppersbusch Palux	55.34329.040 540525 136840
4	375978	116	29-116	1	1NO	16	6	241	400	-	-	23	EGO	55.34021.020
5	375547	120	30-120	3	3NO	16	11	28	900	900	-	23	Ambach EGO	5061603938 55.34022.829
5	390190	185	80-185	3	3NO	16	11	28	900	700	-	23	Ambach EGO EGO	5061603922 55.34032.834 55.34032.839
6	390055	160	66-160	3	3NO	16	8	115	800	-	-	23	EGO Electrolux Morice	55.34039.811 026860 TH1084

fig.	vare nr.	t.max. (°C)	t.range (°C)	NP (-pole)	function	SC (A)	probe ø (mm)	probe L (mm)	cap. (mm)	cap.ins. (mm)	gland nut	shaft L (mm)	suitable for	Ref. No.
7	375872	490	70-490	3	3NO	16	3.9	380	1180	960	-	25	EGO Wamsler	55.34083.050 011170067

55.35_series

fig.	vare nr.	t.max. (°C)	t.range (°C)	NP (-pole)	function	SC (A)	probe ø (mm)	probe L (mm)	cap. (mm)	cap.ins. (mm)	gland nut	shaft L (mm)	suitable for	Ref. No.
1	390805	250	105-250	2	2CO	16	3	146	1500	800	-	23	EGO Electrolux Juno	55.35254.010 0H6223 0H6223



55.40_series



fig.	vare nr.	t.max. (°C)	t.range (°C)	NP (-pole)	function	SC (A)	probe ø (mm)	probe L (mm)	cap. (mm)	cap.ins. (mm)	gland nut	shaft L (mm)	suitable for	Ref. No.
1	375061	90	30-82 / 38-90	4	1CO/3CO	16	6	215	880	800	-	23	EGO Electrolux Therma Zanussi	55.40212.030 046413 046413 046413
1	375658	300	60-204°C/135-300	4	2NO/2NO	16	4	128	880	800	-	23	EGO Küppersbusch Palux	55.40052.070 540568 634980
1	375096	450	100-450	4	4NO	16	3.9	163	1180	850	-	23	Ascobloc EGO EKU MKN	093305 55.40083.010 4-116 203407

55.60_series

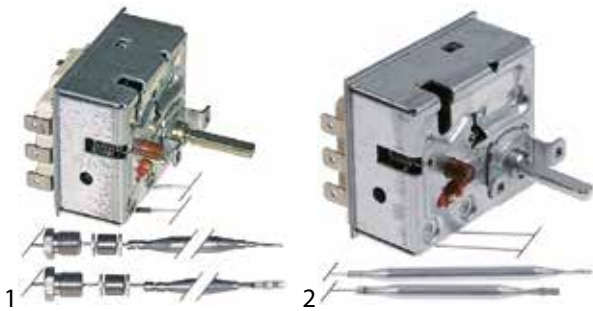

fig.	vare nr.	t.max. (°C)	t.range (°C)	NP (-pole)	function	SC (A)	probe ø (mm)	probe L (mm)	cap. (mm)	cap.ins. (mm)	gland nut	shaft L (mm)	suitable for	Ref. No.
1	390015	180	135-180	3	3NC/3NO	16	6	167/87	1770	-	M9x1	23	EGO Ubert	55.60035.010 342213
2	390752	195	53-195	3	3NC/3NO	16	6	107/87	1470	-	-	23	EGO	55.60034.010
2	375853	270	120-270	3	3NC/3NO	16	6	100/80	870	770	-	23	EGO	55.60052.020
2	376007	120/130	-50 up to +130	3	3NC/3NO	-	6	85/100	870	870	-	-	EGO	55.60012.530



safety thermostats

51._ series



fig.	vare nr.	SOT (°C)	NP (-pole)	SC (A)	probe ø (mm)	probe L (mm)	cap. (mm)	cap.ins. (mm)	gland nut	probe	suitable for	Ref. No.
1	375323	229	1	0.5	6	142	830	-	M9x1	SS	EGO Electrolux Juno Mareno	51.32915.070 0H6139 0H6139 MA1031028000
2	375074	365	2	16	4	116	1170	1100	-	-	EGO Krefft Rational	51.64945.020 76-30140322 3014.0322
3	375090	365	2	16	4	120	1170	1100	-	SS	EGO Krefft Küppersbusch Rational Rosinox	51.64945.010 76-30140310 407275 3014.0310 RX24848111

55.10/19_ series



fig.	vare nr.	SOT (°C)	NP (-pole)	SC (A)	probe ø (mm)	probe L (mm)	cap. (mm)	cap.ins. (mm)	gland nut	probe	suitable for	Ref. No.
1	390738	107	1	16	6	77	1170	1150	-	-	EGO Elframo Komel	55.19523.010 22180100 22180100
1	375902	125	1	16	6	77	870	700	-	-	EGO Mach	55.19522.040 500064000
1	375278	140	1	16	6	74	900	900	-	-	Cookmax EGO Electrolux Silko	41826630240 55.19522.050 056745 SIR0101394
1	375218	145	1	16	6	130	900	900	-	SS	EGO EGO Gico Lainox	55.10522.801 55.19522.060 6340004014500 LAR65070080
1	375982	154	1	16	3	227	900	850	-	-	Ambach EGO	5061600808 55.19522.080
1	375379	200	1	0.5	6	130	900	900	-	-	EGO EGO Olis	55.10542.808 55.19532.010 BN9000217
1	390047	220	1	0.5	3	174	800	-	-	SS	EGO EGO	55.10549.811 55.19549.040
1	390061	220	1	0.5	6	140	900	-	-	M9x1	Cookmax EGO EGO EGO Heidebrenner Mareno Olis	6A049401 55.10542.814 55.10542.841 55.19542.010 94306 MA732913 BN6A049401

Table continues overleaf





fig.	vare nr.	SOT (°C)	NP (-pole)	SC (A)	probe ø (mm)	probe L (mm)	cap. (mm)	cap.ins. (mm)	gland nut	probe	suitable for	Ref. No.
1	390063	220	1	15	6	77	870	-	-	SS	EGO EGO Electrolux Multi	55.10542.831 55.19542.200 0780057347 661021
1	375197	220	1	16	6	142	2970	2600	-	SS	EGO EGO Mareno	55.10546.840 55.19546.010 MA1568700
1	375391	224	1	0.5	6	133	870	-	M10x1	-	EGO	55.19542.040
1	375371	225	1	0.5	6	86	2020	1770	-	SS	EGO Gico	55.19549.030 53400112220
1	375339	225	1	0.5	6	133	870	-	M10x1	-	EGO EGO Emmepi Giorik Mareno MBM-Italia Olis VEGA	55.10542.830 55.19542.020 808181 6010020 MA732913 RTBF900094 BN6A049401 93239G
1	375617	230	1	16	6	133	870	700	-	SS	Baron EGO Olis	BN41826630390 55.19542.110 BN9000515
1	390062	235	1	0.5	6	130	1800	1500	M9x1	SS	Alpeninox Bertos EGO EGO Electrolux GIGA Ilsa Modular Silko Star10 Zanussi	0A2011 32070200 55.10545.800 55.19545.010 0A2011 X49500 R_60986 66102100 SIR0109056 Y16300 0A2011
1	375233	235	1	16	6	133	870	830	-	SS	Bonnet EGO EGO Lotus	5519542090 55.10542.842 55.19542.090 537001300
1	375352	245	1	16	6	130	1200	1200	-	-	EGO EGO GIGA Rosinox Silko Star10	55.10543.802 55.19543.010 X49500 RX94804986 SIR0109056 X49500
1	375311	250	1	16	6	87	1470	1460	-	SS	EGO OEM	55.19544.020 ED04900
1	375337	300	1	16	6	74	900	700	-	-	EGO EGO Emmepi	55.10552.806 55.19552.020 C00546
1	375285	327	1	16	6	77	870	-	-	SS	EGO EGO Olis Silko	55.10562.830 55.19562.020 BN6A049500 SIR0101387
1	375378	350	1	16	6	74	900	-	-	SS	EGO EGO Ilsa Olis	55.10562.828 55.19562.010 60761 BN6A046170

Table continues overleaf

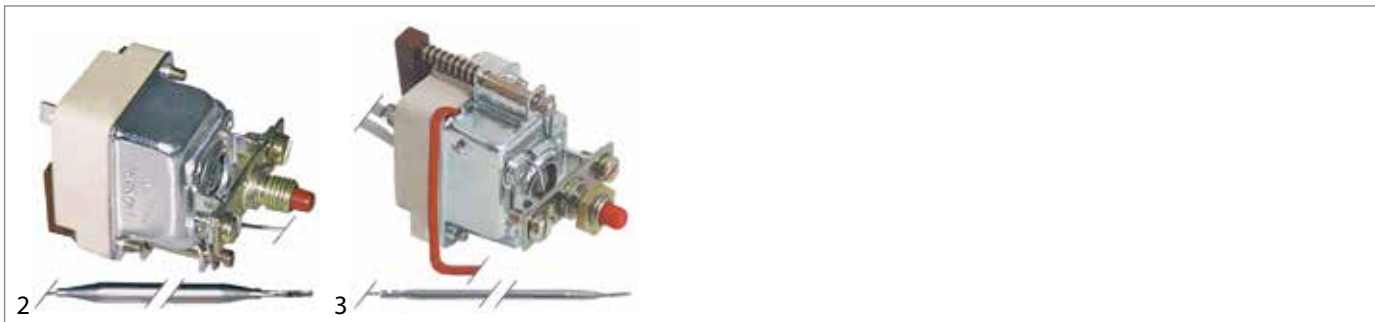

fig.	vare nr.	SOT (°C)	NP (-pole)	SC (A)	probe ø (mm)	probe L (mm)	cap. (mm)	cap.ins. (mm)	gland nut	probe	suitable for	Ref. No.
1	376008	352	1	16	3	200	885	780	-	-	EGO	55.19562.120
1	375656	360	1	0.5	3.1	201	900	870	-	SS	EGO MBM-Italia	55.19572.020 RTBF800076
1	390786	360	1	16	4	128	1170	990	-	-	EGO Tecnoinox	55.19573.010 RC00770000
1	375968	360	1	16	6	77	870	660	M10x1	-	EGO Giorik Lincar MBM-Italia	55.19562.030 6010026 40000914 RTFOC00483
1	375662	512	1	16	3.9	228	1470	960	-	SS	EGO Moretti	55.19584.010 74200370
2	375250	130	1	16	6	129	870	-	-	SS	Bertos EGO EGO EGO Electrolux Ilsa Tecnoinox	25070000 55.10522.020 55.10522.802 55.19522.020 004912 34440 RC00427000
2	375376	224	1	0.5	6	133	870	-	M10x1	-	Baron EGO Emmepi Giorik Offcar Rosinox Silko	85322001046 55.10542.853 808181 2011140 862133 RX94805702 SIR0108038
2	390060	230	1	0.5	6	77	870	-	-	SS	EGO EGO EGO Electrolux Foem Tecnoinox	55.10542.805 55.19542.130 55.32542.823 004951 05750107250 RC00450000
3	375178	230	1	0.5	4	116	1500	-	-	SS	EGO Elframo GIGA Komel	55.19544.010 22170001 X56700 22170001
3	390730	230	1	15	4	125	1550	1410	-	-	EGO Elframo Repagas	55.19549.050 22170003 09500064
3	375227	238	1	0.5	4	116	900	700	M9x1	SS	EGO EGO Gico	55.10542.807 55.19542.140 5340011200

Table continues overleaf

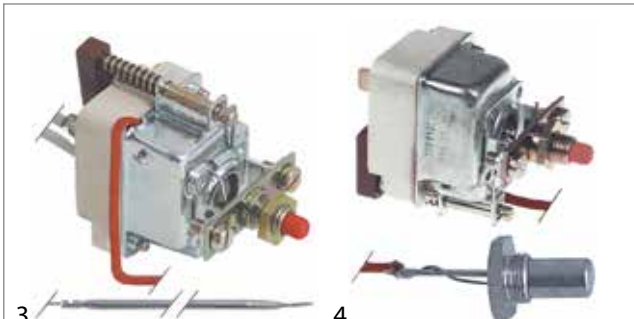



fig.	vare nr.	SOT (°C)	NP (-pole)	SC (A)	probe ø (mm)	probe L (mm)	cap. (mm)	cap.ins. (mm)	gland nut	probe	suitable for	Ref. No.
3	375857	350	1	16	3.1	201	870	870	-	SS	Coven EGO	EMTSS350 55.19562.040
3	375353	355	1	0.5	4	120	870	870	-	SS	Anitec EGO EGO GIGA Star10	Y16500 55.10572.800 55.19572.010 Y16500 Y16500
4	375166	230	1	0.5	11	16.5	850	850	-	-	Angelo-Po EGO EGO EGO Gico Silko	32Z8000 55.10542.190 55.10542.828 55.19542.050 55.19542.190 5340101230 SIR0101386
4	375319	230	1	0.5	11	18	900	-	-	-	EGO EGO Modular	55.10542.827 55.19542.170 66103400
4	375282	230	1	16	11	28	850	830	-	-	Bertos EGO EGO GIGA Silko Star10	22070432 55.10542.850 55.19542.030 0000X43400 SIR0109053 0000X43400

55.11_series



fig.	vare nr.	SOT (°C)	NP (-pole)	SC (A)	probe ø (mm)	probe L (mm)	cap. (mm)	cap.ins. (mm)	gland nut	probe	suitable for	Ref. No.
1	390878	80	1	16	4	89	195	-	-	-	EGO Lincat Scholl	55.11119.010 TH35 70.10.07
1	375520	120	1	16	4	91	280	-	M9x1	SS	EGO	55.11529.090
1	375767	170	1	16	3.1	160	650	600	-	-	EGO Electrolux Emainox Zanussi	55.11539.801 031482 3700014 031482
1	375109	240	1	16	4	91	530	350	-	SS	Bartscher Capic EGO Pieffe Roller Grill Saro Valentine	A010501 E401002 55.11549.080 0024 A06004 34-1370 9021-53
1	375120	245	1	16	6	77	2290	2260	-	SS	EGO Fagor	55.11549.050 12024600
2	375461	92	1	16	9/15	20	50	-	-	-	EGO Fagor	55.11519.030 12023818



55.13_series



fig.	vare nr.	SOT (°C)	NP (-pole)	SC (A)	probe ø (mm)	probe L (mm)	cap. (mm)	cap.ins. (mm)	gland nut	probe	suitable for	Ref. No.
1	390895	60	1	16	6	74	520	430	-	-	EGO	55.13519.190
1	390348	98	1	16	8	81	1050	-	-	-	Animo EGO	03047 55.13519.070
1	375149	110	1	16	6	98	2930	500/500	-	SS	EGO Krefft	55.13526.010 602864
1	375910	115	1	16	6	78	350	-	M9x1	-	CoffeeQueen EGO	220220 55.13521.010
1	390471	125	1	16	4	128	1130	800	-	SS	EGO Hobart	55.13523.060 227879
1	375854	126	1	16	6	129	1730	800	M9x1	-	EGO Electrolux Therma Zanussi	55.13525.050 0E5086 0E5086 0E5086
1	390453	130	1	16	6	77	830	700	M9x1	-	EGO	55.13522.380
1	375519	130	1	16	6	129	830	-	-	SS	EGO Küppersbusch MKN Thielmann	55.13522.090 540414 203480 143830
1	375048	132	1	16	3.1	248	830	-	M9x1	SS	Animo EGO EGO	03093 55.13522.020 55.13522.400
1	390845	132	1	16	3.1	248	830	-	M9x1	SS	EGO Falcon	55.13522.020 734311090
1	375731	135	1	16	6	77	520	-	-	SS	Convothem EGO	5001026K 55.13529.210
1	375898	140	1	16	4	125	900	420	-	-	EGO	55.13522.470
1	375784	140	1	16	6	77	870	790	-	SS	EGO Franke Salvis	55.13522.200 178982 178982
1	375214	140	1	16	6	77	1540	1350	-	SS	EGO Jemi Morice	55.13529.170 2006062 TH1290
1	390801	140	1	16	6	78	1500	-	-	-	Bourgeois EGO	THER013 55.13524.030
1	375152	145	1	16	4	100	1130	-	-	SS	EGO Wiesheu-Wiwa	55.13523.070 36035
1	375115	145	1	16	6	73	830	-	-	SS	Casta EGO Jünger	99900159 55.13522.050 422000
1	375040	150	1	16	6	83	830	-	-	SS	EGO	55.13522.190
1	375306	160	1	16	6	75	1540	1490	-	SS	EGO EGO	55.13522.070 55.13539.040
1	375106	190	1	16	3.1	178	350	-	M9x1	SS	EGO Electrolux Juno Therma	55.13531.010 0H6142 0H6142 0H6142
1	375619	220	1	16	6	77	830	-	M9x1	-	EGO KSF Morice	55.13542.200 4.011.03.03 TH1120
1	375981	225	1	16	6	88	900	-	-	-	Capic EGO	E401007 55.13542.140
1	375205	225	1	16	11	16.5	830	-	-	-	EGO Fagor	55.13542.110 12017873
1	390911	230	1	16	6	77	670	180	-	-	EGO Lincat Parry	55.13549.010 TH11 —

Table continues overleaf



fig.	vare nr.	SOT (°C)	NP (-pole)	SC (A)	probe ø (mm)	probe L (mm)	cap. (mm)	cap.ins. (mm)	gland nut	probe	suitable for	Ref. No.
1	375138	230	1	16	6	96	1050	-	M9x1	SS	EGO Lincat	55.13549.030 TH51
1	390896	234	1	16	6	98	1090	660	M9x1	-	EGO	55.13549.060
1	375039	246	1	16	6	77	830	-	-	SS	EGO	55.13542.900
1	390124	246	1	16	6	77	830	-	M9x1	-	EGO MKN	55.13542.100 203492
1	375678	290	1	16	4	111	710	450	-	SS	EGO FriFri	55.13549.050 400375
1	390847	314	1	16	6	77	870	-	M9x1	-	EGO	55.13562.090
1	390505	320	1	16	6	77	1540	1250	-	-	EGO	55.13569.070
1	375416	329	1	16	3.03	160	1230	1060	-	-	EGO Fagor	55.13569.010 12019062
1	390804	340	1	16	3	160	870	600	-	-	EGO Repagas	55.13562.170 73313025
1	390126	340	1	16	3.1	201	1170	-	-	SS	Convothem EGO	5001029K 55.13563.020
1	375076	350	1	16	3.03	141	830	450	-	SS	EGO Electrolux Juno	55.13562.060 0H6243 0H6243
1	375441	360	1	16	3.03	160	870	700	-	-	EGO Fagor	55.13572.090 12024591
1	375830	365	1	16	3	160	1730	1710	-	-	Ambassade Bartscher Bonnet Capic EGO Thirode	6538562 020411 905886 E401003 55.13575.020 905886
1	375121	420	1	16	3.9	228	1130	700	-	-	EGO Fagor	55.13583.010 12024691
2	375044	178	1	16	4	91	1730	1600	-	-	EGO Electrolux Juno MKN	55.13525.010 0H6141 0H6141 203185
3	375156	291	1	16	5	90	870	-	-	SS	EGO Electrolux Juno	55.13552.160 0K1877 0K1877



55.14_series

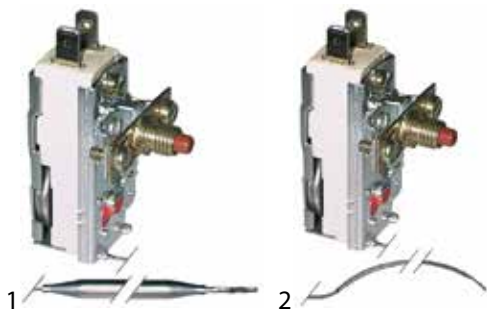

fig.	vare nr.	SOT (°C)	NP (-pole)	SC (A)	probe ø (mm)	probe L (mm)	cap. (mm)	cap.ins. (mm)	gland nut	probe	suitable for	Ref. No.
1	390136	98	1	16	6	86	1500	-	-	-	EGO	55.14514.805
1	390176	230	1	16	6	74	600	-	-	SS	EGO Elframo Komel	55.14549.804 22130001 22130001
1	375260	240	1	16	6	77	1280	1050	M10x1	SS	Baron EGO Electrolux Emmepi Giorik Silko	A6010006 55.14549.826 003121 808430 6010006 SIR0108011
1	375610	340	1	16	3.03	144	880	750	M9x1	-	EGO Inoxtrend	55.14562.803 C2198-00
2	375137	250	1	16	3.03	160	880	800	-	SS	EGO	55.14542.040
2	375793	250	1	16	3.03	160	990	800	-	SS	EGO	55.14549.020

55.31_series



fig.	vare nr.	SOT (°C)	NP (-pole)	SC (A)	probe ø (mm)	probe L (mm)	cap. (mm)	cap.ins. (mm)	gland nut	probe	suitable for	Ref. No.
1	375175	115	3	20	6	173	830	770	-	SS	EGO Palux	55.31522.060 294020
1	390165	140	3	20	6	173	830	800	-	SS	EGO Electrolux Juno Zanussi	55.31532.060 051644 051644 051644
1	390045	160	3	0.5	6	173	830	800	-	SS	EGO Electrolux Zanussi	55.31532.050 051637 051637
1	375573	225	3	20	6	157	940	800	-	SS	EGO Electrolux Zanussi	55.31549.050 059552 059552
1	375803	225	3	20	6	269	830	-	-	-	EGO Hobart Lincat	55.31542.100 4936005 TH19
1	375102	230	3	20	6	219	1730	1400	-	SS	EGO Krefftt Küppersbusch	55.31545.020 49-176174 176174
1	390091	230	3	20	6	239	830	-	-	SS	EGO Elframo Komel Olis Repagas	55.31542.140 22150001 22150001 BN6A046900 8700021
1	375686	250	3	20	6	219	1430	1100	-	SS	EGO Malag	55.31544.030 174963

Table continues overleaf



fig.	vare nr.	SOT (°C)	NP (-pole)	SC (A)	probe ø (mm)	probe L (mm)	cap. (mm)	cap.ins. (mm)	gland nut	probe	suitable for	Ref. No.
1	375641	250	3	20	6	239	2530	1600/210	-	SS	EGO Electrolux Juno Zanussi	55.31549.040 054932 054932 054932
1	390087	250	3	20	6	239	2530	1600/210/375	-	SS	EGO Electrolux Zanussi	55.31546.020 051369 051369
1	375108	250	3	1x20/2x0.5	6	157	1230	800	-	SS	EGO Electrolux Therma Zanussi	55.31549.020 052331 052331 052331
1	375588	285	3	1x20/2x0.5	6	157	940	940	-	-	EGO Electrolux Zanussi	55.31559.020 053183 053183
1	375127	290	3	20	6	220	840	-	-	-	EGO FriFri	55.31552.150 400189
1	375679	295	3	20	4	157	670	350	-	SS	EGO FriFri	55.31549.930 400364
1	375571	350	3	20	6	157	940	890	-	SS	EGO Electrolux Juno Zanussi	55.31566.010 051454 051454 051454
1	375377	350	3	1x20/2x0.5	6	157	1230	1100	-	-	Bake-Off EGO Electrolux Juno Zanussi	182500022 55.31569.010 051643 051643 051643
2	375524	135	3	20	6	173	1430	800	M9x1	SS	EGO MKN Palux	55.31524.030 203493 291749
2	375104	230	3	20	6	167	830	600	M10x1	-	EGO EGO Ilisa Mareno	55.31542.120 55.31542.240 5531542120 MA1037035900
2	390168	230	3	20	6	239	830	-	M9x1	SS	EGO Mareno Modular Multi Nayati	55.31542.050 733100 66100900 661009 G52229
2	375521	240	3	20	6	177	2380	1100	M9x1	SS	EGO EGO EGO Electrolux King MKN	55.31549.010 55.31549.060 97.55315.089 0H7487 0H7487 203482
2	375047	320	3	20	6	177	1430	800	M9x1	SS	EGO Electrolux Juno	55.31554.020 0H6136 0H6136
3	390066	220	3	20	14	105	820	660	-	-	EGO Mareno Palux	55.31542.080 MA893100 088562



55.32_series



fig.	vare nr.	SOT (°C)	NP (-pole)	SC (A)	probe ø (mm)	probe L (mm)	cap. (mm)	cap.ins. (mm)	gland nut	probe	suitable for	Ref. No.
1	390164	105	3	20	4	107	410	250/280	-	-	EGO	55.32521.160
1	375431	105	3	20	6	94	1490	1350	M9x1	SS	EGO	55.32524.170
1	375139	108	3	20	3	190	600	600	-	SS	EGO Elettrobar	55.32519.801 236032
1	390424	110	3	20	6	74	2000	2000	-	-	Adler EGO Rosinox	20503 55.32519.802 RX94800505
1	390907	110	3	20	6	95	1500	1400	-	-	Dihl EGO Kromo	DW15553 55.32524.140 DW15553
1	390178	118	3	20	6	74	900	900	-	SS	EGO Elframo Komel	55.32529.801 22100002 22100002
1	390244	120	3	20	6	94	540	500	-	SS	EGO Meiko	55.32529.190 9502526
1	375947	120	3	20	6	94	900	850	-	-	EGO Mareno Silko	55.32522.858 CR0585120 CR0585120
1	375511	130	3	20	3	300	1500	450	M9x1	SS	Animo EGO	03106 55.32524.070
1	375888	132	3	20	6	87	890	850	-	SS	Baron Cookmax EGO EGO Olis	6A049407 6A049407 55.32522.550 55.32522.845 BN6A049407
1	375199	132	3	2x20/1x0.5	6	77	890	-	M10x1	SS	Baron Cookmax EGO Mareno Rosinox Silko	MA1878900 1878900 55.32522.843 MA1878900 RX94812642 MA1878900
1	375333	135	3	20	3.1	225	890	890	-	SS	EGO MBM-Italia	55.32522.814 RTCP900074
1	375394	135	3	20	6	73	1490	1350	M9x1	SS	Desco EGO Electrolux Juno Mareno Therma	60774 55.32524.160 0K3967 0K3967 MA2613300 0K3967
1	375208	139	3	2x20/1x0.5	6	77	890	-	M9x1	SS	Angelo-Po EGO Mareno	32V398 55.32522.810 MA2865100
1	390920	140	3	20	6	88	900	770	-	-	EGO Electrolux	55.32522.480 0C2983
1	375209	140	3	20	6	89	900	900	-	SS	Angelo-Po EGO EGO Electrolux Lasa Mareno	32Z2011 55.32522.815 55.32522.846 004862 3267260 1037305000
1	375316	140	3	20	6	173	830	800	-	SS	EGO Modular	55.32522.808 66105100
1	375150	145	3	20	3	178	1790	-	M9x1	-	EGO Electrolux Juno Therma	55.32525.060 0H6219 0H6219 0H6219

Table continues overleaf



fig.	vare nr.	SOT (°C)	NP (-pole)	SC (A)	probe ø (mm)	probe L (mm)	cap. (mm)	cap.ins. (mm)	gland nut	probe	suitable for	Ref. No.
1	375281	150	3	0.5	3	188	1100	-	-	SS	Bertos EGO Emmepi Rosinox Silko	31290200 55.32529.810 808203 RX94812646 SIR0102493
1	375861	150	3	16	6	98	4800	-	-	-	EGO Meiko	55.32527.010 9500473
1	375545	150	3	20	3.1	219	890	890	-	-	Ambach EGO	5061603828 55.32522.827
1	375277	150	3	20	6	79	900	700	-	-	Baron EGO Emmepi Giorik Rosinox Silko	BN41826630350 55.32522.811 808057 6010002 RX94805413 SIR0108113
1	390166	150	3	20	6	87	1490	1250	M9x1	SS	Angelo-Po EGO Faema	3222710 55.32524.030 3231133006
1	375454	154	3	20	6	87	890	800	-	-	Bezzera EGO Reneka	7434001 55.32522.210 9101000
1	375438	156	3	20	6	87	1490	1350	-	-	Angelo-Po	3014261
1	375649	160	3	20	6	87	890	880	-	SS	Bertos EGO Foinox Inoxtrend Whirlpool	25070100 55.32532.809 3023 LC-351 483286002546
1	375380	160	3	20	6	89	900	900	-	SS	Cookmax EGO Olis	6A049405 55.32532.805 BN6A049405
1	375259	165	3	20	6	77	2440	800	M9x1	SS	EGO	55.32539.030
1	390324	169	3	20	4	128	890	210/210	-	SS	Astoria Carimali EGO Elektra Faema Gaggia La Cimbali La San Marco La-Spaziale QualityEspresso Rancilio Sanremo	20300015 95.01594 55.32532.020 02790035 531-193 100 07476906 531-193-100 108463 1477 07476906 34200095 10111015
1	375577	170	3	0.5	6	87	900	800	-	-	EGO Electrolux Zanussi	55.32532.824 005295 005295
1	375502	177	3	20	4	130	1500	420	-	-	EGO	55.32534.802
1	375364	180	3	20	4	120	3000	3000	-	-	Bertos EGO Firex GIGA Lincar Offcar Olis	35300000 55.32532.829 40100041 E10500 40000926 FX40100041 BN6A001415
1	390928	196	3	20	6	87	890	350	-	-	EGO Meiko	55.32532.190 9502027
1	390064	220	3	20	6	133	1890	700	-	SS	Alpeninox EGO Electrolux	0A2204 55.32549.060 0A2204
1	375984	225	3	20	6	94	900	670	M10x1	SS	EGO Lincar	55.32542.835 40000922

Table continues overleaf



fig.	vare nr.	SOT (°C)	NP (-pole)	SC (A)	probe ø (mm)	probe L (mm)	cap. (mm)	cap.ins. (mm)	gland nut	probe	suitable for	Ref. No.
1	375575	230	1	20	6	87	890	-	-	SS	Ambach EGO Electrolux	5061614325 55.32542.836 0C4279
1	375320	230	3	20	6	79	1700	1100	-	SS	Bertos EGO	33070800 55.32549.812
1	375550	230	3	20	6	87	890	-	-	SS	EGO	55.32542.813
1	375707	230	3	20	6	87	1490	1100	M9x1	SS	Ambach Baron EGO EGO Küppersbusch Thielmann	5061603893 BN41826630380 55.32542.070 55.32544.050 540443 144182
1	375189	230	3	20	6	89	3000	2650	M9x1	SS	EGO Mareno	55.32546.801 MA1982000
1	375375	230	3	20	6	94	900	670	M10x1	SS	Baron EGO Giorik Ilsa Lincar MBM-Italia Offcar Rosinox	BN4185326010036 55.32542.857 6010036 31230 40000919 RTBF900081 862123 RX94046363
1	375258	232	3	20	6	94	900	670	M10x1	SS	EGO Emmepi Giorik MBM-Italia Palux Rosinox Silko	55.32542.822 807349 6010037 RTBF800164 961809 RX94812594 SIR0108065
1	375551	235	3	20	4	120	1800	1600	-	SS	Ambach EGO GIGA	5061610988 55.32545.802 AEC001ZR10
1	375393	235	3	20	6	87	1790	1710	M9x1	SS	Ambach EGO Electrolux Gastrofrit Inoksan KSF Lotus Ubert	5061603893 55.32545.090 OKJ144 306025.010 10100051 4.011.03.03 537001400 342212
1	375873	236	3	20	6	77	1190	990	-	-	Baron Cookmax EGO Mareno	1878600 1878600 55.32543.803 MA1878600
1	390787	237	3	20	6	98	1420	1170	-	-	Berner EGO	300109 55.32544.160
1	390215	240	3	20	3.1	226	890	-	-	SS	EGO	55.32542.050
1	390113	240	3	20	4	157	890	350	-	SS	EGO Electrolux Valentine	55.32542.230 OK5033 0705-02
1	375315	240	3	20	6	79	900	900	-	SS	EGO Modular	55.32542.807 66104800
1	375704	240	3	20	6	87	890	600	-	SS	EGO Haka Morice	55.32542.130 9047 TH1087
1	375290	240	3	20	6	87	2000	1800	-	SS	Angelo-Po Anitec EGO Morice Star10	32Z3631 072027 55.32549.050 TH1087 072027
1	375585	245	3	0.5	6	79	900	900	-	SS	EGO Electrolux Zanussi	55.32549.814 006282 006282
1	375312	245	3	20	4	120	1800	1800	-	SS	Baron Bartscher Cookmax EGO Olis	BN8219602 023965 8219602 55.32545.800 BN8219602
1	375536	245	3	20	6	75	900	670	M10x1	SS	EGO Silko	55.32542.803 SIR0108061
1	390813	245	3	20	6	78	1500	1050	M9x1	-	Bartscher Charvet EGO	049050 07665A 55.32544.130

Table continues overleaf



fig.	vare nr.	SOT (°C)	NP (-pole)	SC (A)	probe ø (mm)	probe L (mm)	cap. (mm)	cap.ins. (mm)	gland nut	probe	suitable for	Ref. No.
1	375578	245	3	20	6	87	2700	1600	-	SS	EGO Electrolux Zanussi	55.32549.811 004472 004472
1	375724	246	3	20	6	79	1300	1100	-	SS	EGO Forved	55.32549.824 03299/A
1	375240	250	3	20	6	87	2310	2300	-	SS	EGO GIGA	55.32549.806 X43700
1	375580	250	3	20	6	89	900	900	-	SS	EGO Electrolux Zanussi	55.32542.859 005941 005941
1	375059	255	3	20	3.1	307	730	700	-	SS	EGO Palux	55.32559.010 027332
1	375694	255	3	20	6	77	1490	1100	-	SS	EGO Roka	55.32554.060 8900253
1	375557	270	3	20	6	79	900	900	-	SS	EGO Electrolux Zanussi	55.32552.814 006307 006307
1	375840	270	3	20	6	79	2000	-	-	SS	Angelo-Po EGO	32V6560 55.32559.814
1	375286	285	1	0.5	4	120	1500	1500	-	-	Angelo-Po EGO	32Z5610 55.32554.800
1	375340	295	3	20	4	120	1800	-	-	-	EGO Electrolux	55.32555.800 004921
1	375045	315	3	20	6	77	1490	1100	M9x1	SS	EGO Electrolux Juno	55.32564.010 0H6215 0H6215
1	375206	325	3	20	3.1	188	900	700	M10x1	SS	EGO Mareno	55.32562.810 MA2864714
1	375418	340	3	20	4	128	1190	-	-	SS	EGO Lohberger	55.32563.010 51440160
1	375279	345	3	20	4	120	900	900	-	SS	EGO Rosinox Silko	55.32562.835 RX94812622 SIR0101372
1	375163	350	3	0.5	6	79	3000	2800	-	SS	EGO Mareno	55.32566.800 1475513
1	375228	350	3	20	3	188	900	900	-	SS	Casta EGO Gico Ilsa Lincar MBM-Italia Offcar Olis Smeg	85900019 55.32562.808 53403000350 843737 40000920 RTC0800152 843737 A046150 818731004
1	375628	350	3	20	4	120	900	670	M10x1	SS	EGO Giorik Lincar	55.32562.807 6010008 40000923
1	375262	350	3	20	4	120	900	900	-	-	EGO Modular	55.32562.802 66104500
1	375695	350	3	20	6	77	890	-	-	SS	EGO Küppersbusch Thielmann	55.32562.090 540470 251116
1	390141	350	3	20	6	77	1490	800	-	SS	EGO Electrolux Juno Öztiryakiler Therma	55.32564.040 006826 006826 6234.00001.28 006826
1	375338	350	3	20	6	79	900	700	-	SS	EGO Emmepi	55.32562.829 C00098

Table continues overleaf



fig.	vare nr.	SOT (°C)	NP (-pole)	SC (A)	probe ø (mm)	probe L (mm)	cap. (mm)	cap.ins. (mm)	gland nut	probe	suitable for	Ref. No.
1	375388	350	3	20	6	89	1000	960	-	SS	EGO Olis Tecnoeka	55.32569.800 BN6A046160 09950347000
1	375252	350	3	20	6	89	3000	960	-	-	Anitec EGO GIGA Star10	X44800 55.32566.806 X44800 X44800
1	390836	355	3	20	4	120	1890	-	-	-	EGO MIWE	55.32579.040 504024.30
1	390142	360	3	20	3.1	188	1490	800	-	SS	EGO Electrolux Emmepi Giorik Juno Multi Olis Smeg Tecnoinox Zanussi	55.32574.040 004919 807790 5910029 004919 661045 BN6A046150 818731004 RC00305000 004919
1	375562	360	3	20	4	120	900	900	-	SS	Baron Cookmax EGO Electrolux Zanussi	41826630130 41826630130 55.32562.806 004269 004269
1	375392	360	3	20	4	120	1490	1450	-	SS	Ambach Convotherm EGO GIGA MKN Silko Wiesheu-Wiwa	5061616223 5001039 55.32574.110 Y72100 203484 SIR0101375 38643
1	375350	360	3	20	4	120	1800	1800	-	SS	Bertos EGO Firex GIGA Lincar Lotus Modular Offcar Star10	35301400 55.32575.801 40100062 Y16600 40000921 40100062 40100062 FX40100062 X49900
1	375187	360	3	2x20/1x0.5	6	79	890	-	-	SS	Baron Cookmax EGO Silko	MA1878500 1878500 55.32562.822 MA1878500
1	375563	360	3	1x20/2x0.5	6	79	1200	1200	-	SS	EGO Electrolux Zanussi	55.32573.801 004600 004600
1	375680	365	3	20	4	100	1190	400	-	SS	EGO Palux	55.32573.100 502537
1	375307	365	3	20	4	120	1300	1250	-	SS	Angelo-Po EGO EGO	32Z9202 55.32569.814 55.32579.800
1	375706	400	3	20	3.9	228	1190	-	-	SS	Bonnet Capic EGO Küppersbusch Morice Thielmann	301049 E401090 55.32573.030 540406 TH1122 144095
1	390181	420	3	20	3.9	306	870	850	-	SS	EGO EGO Lotus MBM-Italia Olis	55.32582.804 55.32582.807 537012800 RTBF800192 BN6A046180
1	375627	480	3	20	4	230	890	-	-	-	EGO Küppersbusch Palux	55.32582.020 540559 603589
1	375065	500	3	20	4	308	890	-	-	SS	EGO EGO Eloma OEM Zanolli	55.32582.800 55.32582.815 ELE336005 ED05500 TERM0005
1	375681	520	3	20	3.9	228	890	400	-	-	EGO Palux	55.32582.030 619221
1	375190	560	3	20	3.9	228	870	700	-	-	Cuppone EGO Electrolux Pizza-Group	91310051 55.32582.814 004205 A88TX85001

Table continues overleaf



fig.	vare nr.	SOT (°C)	NP (-pole)	SC (A)	probe ø (mm)	probe L (mm)	cap. (mm)	cap.ins. (mm)	gland nut	probe	suitable for	Ref. No.
1	375257	580	3	20	4	163	1200	-	-	-	Ambach EGO Inoksan Pizza-Group	5061621356 55.32583.804 10100001 A88TX85003
2	375275	125	1	0.5	4	120	900	900	-	SS	EGO Rosinox Silko	55.32522.831 RX94805231 SIR0101404
2	375622	147	1	20	6	89	900	800	-	-	Baron EGO Lotus	BN41853310064 55.32522.837 10064
2	390159	150	1	20	6	89	900	800	-	-	Ambach EGO Lainox	R65070081 55.32522.852 LAR65070081
2	375586	245	1	0.5	6	77	1290	1100	-	SS	EGO EGO EGO Electrolux Zanussi	55.32542.807 55.32549.816 55.32549.827 0A5435 0A5435
2	375916	259	1	20	6	88	900	100	-	-	EGO Electrolux	55.32542.858 005931
2	375943	299	1	20	4	123	1500	1400	-	-	Angelo-Po EGO	32Z5612 55.32554.080
2	375357	325	1	0.5	3	188	900	-	-	-	Baron EGO Mareno	MA1942900 55.32562.828 MA1942900
2	375226	340	1	0.5	3	190	900	900	-	SS	EGO Gico	55.32562.800 53403000340
2	375291	344	1	20	6	79	900	900	-	-	Comenda EGO Lainox	M100780 55.32562.820 LAR65070060
2	375344	360	1	0.5	4	120	1500	1500	-	-	Angelo-Po EGO Electrolux Rosinox	32Z1400 55.32574.800 0PRE75 RX94800158
2	375579	360	1	0.5	6	74	1500	1500	-	-	EGO Electrolux Juno Zanussi	55.32574.801 003594 003594 003594
2	375599	360	1	0.5	6	79	890	-	-	SS	Baron Cookmax EGO	41826630010 41826630010 55.32562.819
2	390227	360	3	20	4	120	1800	1800	-	SS	GIGA Lotus Offcar	X49900 40100062 FX40100062
2	376047	368	3	16	3	160	150	76	-	-	Ambassade EGO	6539942 55.32574.080
2	375787	380	2	20	4	163	1190	800	-	SS	EGO Franke Salvis	55.32573.060 1G962526 1G962526
3	375980	130	3	20	6	88	880	-	-	-	Capic Capic EGO	E401008 E401012 55.32522.160
4	375372	225	3	20	11	26	890	700	-	-	EGO EGO Elettrobar Gico	55.32542.150 55.32542.806 236016 53403901221



fig.	vare nr.	SOT (°C)	NP (-pole)	SC (A)	probe ø (mm)	probe L (mm)	cap. (mm)	cap.ins. (mm)	gland nut	probe	suitable for	Ref. No.
5	375358	230	2	1x20/1x0.5	6	74	880	-	M9x1	SS	EGO Mareno	55.32542.833 MA1871100
5	375474	340	2	1x20/1x0.5	4	120	1300	900	-	-	AltoShaam Angelo-Po Convotherm EGO EGO	TT-33325 3111950 5001031 55.32559.805 55.32569.050
5	375808	350	2	0.5	4	120	1300	900	3/8" NPT	-	EGO Sogeco	55.32569.815 TERMOSTATO003
6	375445	230	3	2x20/1x0.5	4	120	900	700	-	-	Baron EGO Mareno Rosinox Silko	MACM097701 55.32542.370 MACM097701 RX94812559 MACM097701
7	390921	305	3	20	4	128	890	800	-	-	EGO Eloma Falcon	55.32562.160 EL0572705 530368679
8	375220	330	3	20	11	18.5	900	900	-	-	Angelo-Po CB EGO Lainox Tecnoinox	3226790 09010019 55.32562.804 LAR65070050 RC00238000
8	375455	350	1	16	11	16	900	900	-	-	EGO Electrolux Juno Lainox Therma Zanussi	55.32562.816 002730 002730 LAR65070070 002730 002730
8	375684	360	1	20	11	16	900	900	-	-	Ambach Cookmax EGO Kelvin Lainox Rosinox	R65070350 R65070350 55.32572.804 0101105 LAR65070350 RX94814230

fig.	vare nr.	SOT (°C)	NP (-pole)	SC (A)	probe ø (mm)	probe L (mm)	cap. (mm)	cap.ins. (mm)	gland nut	probe	suitable for	Ref. No.
9	375659	338	2	1x20/1x0.5	6	53	900	900	-	-	EGO Electrolux Zanussi	55.32562.847 007042 007042



55.33_series

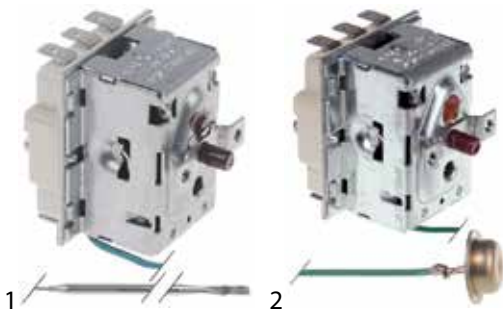

fig.	vare nr.	SOT (°C)	NP (-pole)	SC (A)	probe ø (mm)	probe L (mm)	cap. (mm)	cap.ins. (mm)	gland nut	probe	suitable for	Ref. No.
1	390706	90	3	20	6	114	380	360	-	-	Animo EGO	03089 55.33511.010
1	390470	100	3	20	4	231	870	800	-	SS	EGO Hobart	55.33512.020 378791
1	390883	160	3	20	4	155	880	350	-	SS	Astoria Cookmax EGO WEGA	WY20300019 WY20300019 55.33532.130 WY20300019
1	375467	220	3	20	6	75	1500	-	M9x1	SS	Capic EGO Morice	E401006 55.33544.020 TH0118
1	375796	220	3	20	6	107	870	800	-	-	Ambassade Bartscher EGO Elframo Komel	6537879 06537879 55.33542.040 22150003 22150003
1	390675	230	3	20	6	88	2200	-	-	-	Charvet EGO Imperial-Germany	05996A 55.33549.030 8038266
1	375487	230	3	20	6	103	1170	-	-	-	EGO Lincat	55.33543.020 TH61
1	375430	230	3	20	6	107	870	-	-	-	EGO Lincat	55.33542.090 TH25
1	375746	230	3	20	6	117	1470	1100	M9x1	SS	EGO EGO Gastrofrit MKN	55.33542.050 55.33544.010 306025.005 203489
1	390830	235	3	20	6	108	1470	1100	-	-	EGO Falcon	55.33544.050 539113830
1	375421	240	3	20	3.1	226	1170	960	-	SS	Ascobloc EGO Küppersbusch	8152102 55.33543.010 152102
1	375698	250	3	20	3.1	307	710	700	-	SS	EGO Küppersbusch Palux	55.33559.020 540579 686832
1	375516	250	3	20	6	107	1470	1100	M9x1	SS	EGO Lohberger MKN Palux	55.33544.040 F2072038 203183 637726
1	375781	275	3	20	4	157	870	350	-	SS	EGO Franke Nayati Salvis	55.33542.030 1G962532 PD412F 1G962532
1	375764	282	3	20	4	157	1770	1490	-	SS	EGO Valentine	55.33555.030 6313-SA
1	375770	285	3	20	4	128	870	350	-	SS	EGO Valentine	55.33542.100 0705-04
1	376027	295	3	20	4	128	1770	1750	-	SS	EGO Electrolux Valentine	55.33555.010 OKI686 6314-SA
1	375882	300	3	20	4	157	520	-	-	SS	EGO TurboChef	55.33559.030 102075
2	375118	360	3	20	15	8	1150	1100	-	-	EGO Eloma Falcon Palux	55.33573.070 EL0580457 530336027 580457



56_ series

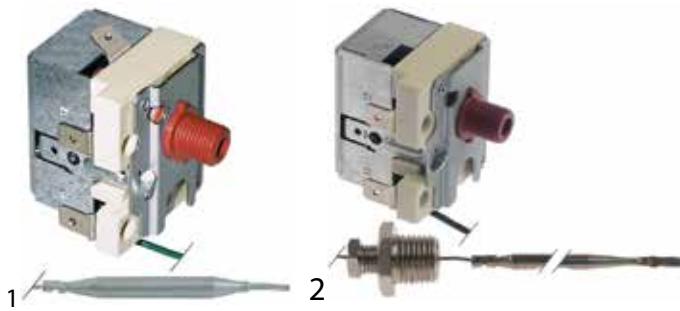

fig.	vare nr.	SOT (°C)	NP (-pole)	SC (A)	probe ø (mm)	probe L (mm)	cap. (mm)	cap.ins. (mm)	gland nut	probe	suitable for	Ref. No.
1	375895	132	1	16	3.1	200	860	400	M9x1	-	Cookmax EGO Melitta	17764 56.10522.560 17764
1	375591	147	1	16	6	77	1860	1350	-	-	EGO Küppersbusch	56.10529.520 152433
1	375447	150	1	16	6	77	1460	1100	M9x1	-	EGO EGO Fagor	56.10524.550 56.10529.510 12024884
1	390797	157	1	16	6	62	1520	1380	-	-	EGO Rational	56.10534.500 40.02.515
1	375862	183	1	16	6	61	1460	1400	-	SS	EGO Rational	56.10534.510 40.01.329
1	375688	230	1	0.5	6	77	700	-	M9x1	SS	EGO Falcon Nayati	56.10549.510 731350021 GS2154
1	390714	230	1	16	6	75	740	200	-	SS	Corsair EGO Elframo Emmepi Lincat Öztiryakiler Repagas	47-003 56.10549.500 00032270 C00926 TH44 6234.00001.16 8500016
1	375432	230	1	16	6	77	1160	210	M9x1	-	Cometto EGO	COM50069 56.10543.500
1	390901	230	1	16	6	77	2280	210	M9x1	-	EGO	56.10549.530
1	375508	235	1	16	3	155	1100	-	-	-	EGO Lincat	56.10549.570 TH71
1	390610	235	1	16	3	190	1000	640	-	SS	Anitec CF-Cenedese Cookmax Faba RM-Gastro Star10	072028.1 63.7.0632 402511000 PR70008 402511000 072028.1
1	390829	240	1	16	6	77	700	-	M9x1	-	EGO Falcon	56.10549.580 537300060
1	390854	245	1	16	3.1	155	1130	-	M9x1	-	EGO Fagor Mareno	56.10549.590 12048400 CR1074320
1	390828	245	1	16	6	78	700	-	M9x1	-	EGO Falcon	56.10549.591 535770070
1	390860	245	1	16	6	78	750	-	M9x1	-	EGO Falcon	56.10549.591 535670017
1	375745	260	1	16	6	77	860	-	-	SS	EGO	56.10552.500
1	375870	340	1	16	3	160	1150	1080	-	-	Convotherm EGO	5001041 56.10563.500
1	375531	340	1	16	4	100	1860	1710	-	-	EGO Küppersbusch	56.10569.500 152432
1	375883	350	1	16	3.03	138	1760	1710	-	SS	EGO TurboChef	56.10565.500 R7603
1	375159	365	1	16	4	96	1160	1100	-	-	EGO Fagor Krefft Rational	56.10573.500 12029569 76-30140326 3014.0326
2	390832	230	1	0.5	6	77	700	-	M9x1	-	Falcon	731310135
2	390977	360	1	16	4	102	1200	820	1/4"	SS	EGO Rational	56.10573.550 3014.0324

Table continues overleaf



fig.	vare nr.	SOT (°C)	NP (-pole)	SC (A)	probe ø (mm)	probe L (mm)	cap. (mm)	cap.ins. (mm)	gland nut	probe	suitable for	Ref. No.
3	375442	320	1	16	4	100	1760	1600	-	-	Bonnet EGO Falcon FriFri Hobart Thirode	301066 56.10555.500 56.10562.500 737600711 601275 301066 301039
3	376006	360		16	3	160	1800	1520	-	-	Blue Seal EGO	025400 56.10565.510
4	375889	360	1	16	15	6.5	1140	1100	-	-	EGO Eloma Palux	56.10573.510 EL0504602 504602
5	375774	365	1	16	4	96	1160	1100	-	SS	EGO Fagor Rational	56.10573.520 12028972 40.01.482

accessories

fig.	vare nr.	application	TS	suitable for	Ref. No.	fig.	vare nr.	application	TS	suitable for	Ref. No.
1	551083	for safety thermostat	M8x1	EGO Electrolux	00.00525.020 0A2187	1	551272	for safety thermostat	M10x0.75	EGO	00.00525.015

control thermostats with operation switch

51._ series

pos.	vare nr.	t.range (°C)	NP (-pole)	function	SC (A)	probe ø (mm)	probe L (mm)	cap. (mm)	cap.ins. (mm)	shaft L (mm)	suitable for	Ref. No.
1	390069	45-265	1	1NO	15	3	219	900	-	23	Angelo-Po EGO	32Z0500 51.43918.410



55.10/19_series



fig.	vare nr.	t.range (°C)	NP (-pole)	function	SC (A)	probe ø (mm)	probe L (mm)	cap. (mm)	cap.ins. (mm)	gland nut	shaft L (mm)	suitable for	Ref. No.
1	390039	30-90	1	1CO	16	6	173	980	980	-	23	Baron Cookmax EGO Electrolux GIGA Morice	41826630230 41826630230 55.10719.800 55.19619.030 051142 X57800 DE0426
1	375946	100-350	1	1NO	16	3	145	900	800	-	25	EGO Mareno Silko	55.19662.010 CR0581280 CR0581280
1	375473	37-110	1	1NO	16	6	129	570	-	-	23	EGO Jünger	55.19629.010 422100
1	375584	91-185	1	1NO	0.5	4	235	2420	1200	-	23	EGO Electrolux	55.19639.030 002602
1	375855	96-180	1	1NO	16	6	133	2420	-	-	23	EGO	55.19639.050
1	375180	99-185	1	1NO	0.5	4	235	870	700	-	23	EGO EGO Lainox Mareno Silko	55.19632.040 97.55196.004 SIR0109170 CR0589660 CR0589660
2	390600	105-185	1	1NO	16	6	130	900	700	M10x1	23	Angelo-Po EGO EGO EGO	32V0240 55.19032.831 55.19932.802 PO98311705
2	375629	30-110	1	1NC	16	6	130	2000	1920	-	23	Ambach	5061603162
2	390799	30-110	1	1NO	16	6	129	870	850	-	23	Ambach EGO	5061608580 55.19622.010
2	375768	50-310	1	1NO	16	4	128	1500	1500	-	23	Angelo-Po EGO	32V6510 55.19662.804
2	375875	53-180	1	1NO	16	6	133	1170	1000	-	23	Baron Cookmax EGO EGO Mareno	1037317300 1037317300 55.10633.800 55.19639.020 MA1037317300
2	375581	55-260	1	1NO	16	4	116	1300	1300	-	23	EGO EGO Electrolux Zanussi	55.10659.800 55.19659.010 002109 002109
2	375331	58-183	1	1NO	0.5	4	116	900	700	-	23	EGO EGO Mareno Rosinox Silko	55.10632.801 55.19632.030 MACM097800 RX94812560 MACM097800
2	390052	90-185	1	1NO	15	4	229	2500	1200/200	-	23	Bartscher EGO EGO Electrolux Juno Therma Zanussi	049672 55.10639.800 55.19639.800 052330 052330 052330 052330
3	375590	57-320	1	1NO	16	3.1	226	870	800	-	23	Ambach	5061602948



55.13_series

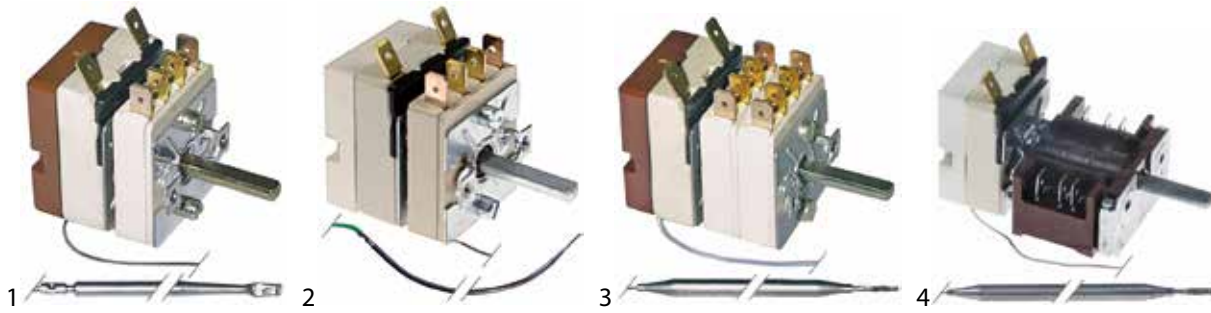

fig.	vare nr.	t.range (°C)	NP (-pole)	function	SC (A)	probe ø (mm)	probe L (mm)	cap. (mm)	cap.ins. (mm)	shaft L (mm)	suitable for	Ref. No.
1	375405	30-90	1	1CO	16	6	98	2380	1700	18	Ascobloc EGO	09/3501 55.13619.210
1	375780	120-190	1	1NO	16	3	248	1730	1660	23	EGO Franke Nayati Salvis	55.13635.020 1G962531 PD412E 1G962531
1	375409	130-400	1	1NO	16	3.9	163	830	350	23	EGO	55.13672.020
1	375052	140-195	1	1NO	16	6	77	830	500	23	EGO MKN	55.13632.030 203481
1	375406	30-110	1	1CO	16	6	113	2380	1700	18	Ascobloc Capito EGO EGO Franke Köhler Esback Kreff Küppersbusch Nayati Salvis	9295433 63892 55.13624.020 55.13629.050 1G873027 3000367 49-355693 355693 PD412B 1G873027
1	375900	30-110	1	1NO	15	6	115	900	810	23	Angelo-Po EGO	32Z9271 55.13622.160
1	375782	30-128	1	1NO	16	3.03	178	870	800	23	EGO	55.13622.120
1	375743	30-80	1	1NO	16	6	115	1430	-	23	Blanco EGO	105126 55.13614.070
1	390902	50-320	1	1CO	16	3.03	160	1300	1230	23	Ascobloc EGO	09/2085 55.13669.030
1	390834	50-320	1	1NO	16	3	160	870	-	23	EGO Falcon Lincat	55.13662.070 731050004 —
1	375408	50-320	1	1NO	16	3.03	160	1150	-	23	Ascobloc Cookmax EGO Franke Kreff Küppersbusch Nayati Salvis	9295400 PD412C 55.13663.010 178855 49-174677 174677 PD412C 1G873056
1	375429	50-320	1	1NO	16	3.03	160	1470	350	23	Blue Seal EGO	017121/51 55.13664.060
1	375489	50-320	1	1NO	16	3.03	160	3150	-	23	EGO	55.13669.050
1	375083	60-250	1	1NO	16	4	100	3150	3090	23	EGO Rational	55.13649.010 3014.0308
1	375613	95-210	1	1NO	16	3.1	201	1770	1600	23	EGO Küppersbusch	55.13645.010 152107
1	375407	97-185	1	1CO	16	6	87	2380	700	23	EGO	55.13639.030
2	375794	30-105	1	1NO	16	3.03	178	870	800	23	EGO	55.13622.140
3	375053	30-110	1	1NO	16	6	113	830	800	23	EGO Electrolux Therma	55.13622.080 OK5023 OK5023
4	390179	30-110	1	1NO	16	6	113	1430	-	23	EGO EGO Köhler Esback	55.13924.010 55.13924.020 3000368, 392080
4	390844	50-291	1	1NO	16	3	160	980	600	25	EGO Falcon	55.13059.180 735400230
4	390848	50-291	1	1NO	16	3	160	980	600	25	EGO Falcon	55.13059.180 732910090



55.34_series

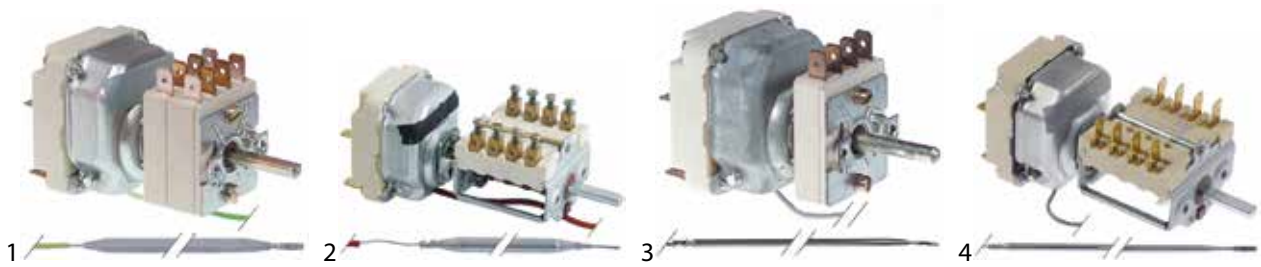

fig.	vare nr.	t.range (°C)	NP (-pole)	function	SC (A)	probe ø (mm)	probe L (mm)	cap. (mm)	cap.ins. (mm)	shaft L (mm)	suitable for	Ref. No.
1	390098	100-180	3	3NO	16	6	133	1780	1600	23	EGO	55.34635.010
1	390788	0-180	3	3NO	-	6	130	1740	1310	23	Berner EGO	400300 55.34635.020
1	375023	103-175/108-180	3	2NO/2NO	16	3.1	305	720	700	23	EGO Küppersbusch Palux	55.34639.010 540511 026611
1	375592	32-110	3	3NO	16	6	138	1180	1100	23	EGO Küppersbusch Palux	55.34613.010 540592 700509
1	390099	43-300	4	4NO	16	6	77	1480	1350	23	EGO EGO	55.34654.010 55.40654.010
1	375955	56-306	3	3NO	16	6	77	1590	1400	23	Berner EGO	500301 55.34669.103
1	375691	60-390	3	3NO	16	3.9	228	1110	600/700	23	EGO Palux	55.34673.010 619248
1	390266	70-255	3	3NO	16	4	128	880	880	23	EGO Palux	55.34642.010 631981
1	390530	77-300	3	3NO	16	4	128	880	800	33	EGO Palux	55.34652.010 606227
2	375269	100-300	3	3NO	16	6	75	1150	1150	23	Angelo-Po	32Z3790
2	375877	100-530	3	3NO	16	3.9	228	1110	1000	23	Electrolux Juno Therma	0G2529 0G2529 0G2529
3	375690	50-300	3	3NO	16	3.03	160	1480	350	24	EGO Nayati	55.34654.020 552028
3	375570	100-470	1	1NO	16	3.9	228	1110	600	24	EGO Electrolux Franke Juno Salvis	55.34683.040 0K0662 179312 0K0662 179312
3	375140	50°C/50-600°C/70-650	3	3NO	16	4	228	1200	1200	23	Ambach Baron EGO Franke Mareno MKN Nayati Palux Salvis Silko	5061610558 CR0688650 55.34683.800 179302 21351299 203408 PD.412K 661635 179302 CR0688650
4	390919	50-300	3	3NO	16	4	292	2300	2260	25.5	EGO Electrolux Therma	55.34059.080 0K5022 077018015428

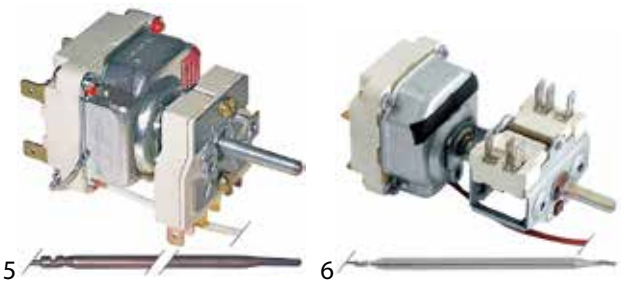



fig.	vare nr.	t.range (°C)	NP (-pole)	function	SC (A)	probe ø (mm)	probe L (mm)	cap. (mm)	cap.ins. (mm)	shaft L (mm)	suitable for	Ref. No.
5	375246	100-615/645	2	2NO	16	4	230	1100	600	25	EGO EGO EKU Electrolux Juno Lohberger MKN Morice Rosinox Solymac	55.34683.010 55.34683.050 3-22 OK0496 OK0496 51440169 203408 DE0254 RX94090032 P709
6	375342	30-110	3	3NO	16	6	130	1200	1200	23	Angelo-Po	32V0060
6	375876	30-85	3	3NO	16	6	131	1440	-	23	Stahl	162015
6	375299	60-330	2	2NO	16	4	128	1500	1450	23	Angelo-Po EGO EGO	32V0661 55.34064.805 55.34964.800

IMIT / TEMPOMATIC / ARTHERMO

control thermostats



fig.	vare nr.	t.range (°C)	NP (-pole)	function	SC (A)	probe ø (mm)	probe L (mm)	cap. (mm)	cap.ins. (mm)	shaft L (mm)	suitable for	Ref. No.
1	375403	30-90	1	1CO	15	6	90	1500	1400	15	Forved Teikos	VETRTERMOST 843630
1	390013	30-90	1	1CO	15	6.5	95	1000	-	19	Rancilio	34200051
1	375986	265	1	1NO	15	4	90	900	20	18	Cookmax Sirman	IGS704203 IGS704203
1	375399	50-300	1	1CO	15	4	97	900	-	19	Amitek Sirman	R00221 IB5866400
1	390399	-	1	1CO	16	6.5	110	1500	1450	19	ATA Camurri	1080 neu 050B0231
1	390707	-	1	NC	16	7	90	150	-	23	La-Spaziale	11168
1	375939	0-200	1	1CO	16	5	98	1040	-	20	Cooking-Systems	C5322059
1	375891	0-85	1	1CO	15	6	78	1000	-	15	Cookmax Hatco	X02.16.136.00 X02.16.136.00

Table continues overleaf



fig.	vare nr.	t.range (°C)	NP (-pole)	function	SC (A)	probe ø (mm)	probe L (mm)	cap. (mm)	cap.ins. (mm)	shaft L (mm)	suitable for	Ref. No.
1	390006	0-86	1	1CO	16	6.5	95	1500	-	19	Angelo-Po Anitec ATA Bartscher CF-Cenedese Classeq Colged Comenda Dexion Elettobar Hoonved Lasa Mareno MBM-Italia NuovaSimonelli OEM Palux Sammic Silanos Star10	32V1910 072029 7280 0929044 63.7.0658 7.12.1/2 DRT11 120501 014688-00 929044 H120501 3264000 120501 014688-00 18010043 ED00100 208418 2309068 907100 072029
1	375885	0-86	1	1CO	16	6.5	97	1500	-	18	Dihr Hemerson Kromo Luxia	DW10707/1 041001 DW10707/1 L2060
1	390683	0-86	1	1CO	16	6.5	98	1000	960	20	Silanos	TR0440
1	390914	0-90	1	1CO	10	6.5	97	1000	950	12	Comenda Hoonved	120515 120515
1	375805	0-90	1	1CO	15	6.5	85	1000	900	19	Acopa VEGA	10020 93001
1	375847	0-90	1	1CO	15	6.5	100	1500	-	18	Astoria Cookmax Sirman VEMA	20314 IV5863500 IV5863500 XRCU20
1	390173	27-87	1	1CO	15	6.5	95	1000	1000	19	Elframo Komel	00057150 00057150
1	375620	30-120	1	1CO	15	6.5	95	1000	1000	19	Forved	VETRTER120
1	390007	40-120	1	1CO	16	6.5	95	1000	-	19	Bertos Camurri	24064000 050B0230
1	390009	56-310	1	1CO	16	3.5	195	1000	-	19	—	—
1	390008	64-210	1	1CO	16	5	125	1000	-	19	Dexion MBM-Italia	019310-00 019310-00
2	390460	30-90	1	1CO	16	6.5	95	2000	1950	-	Dihr Kromo Lamber Olis Rosinox WEGA	DW10707/1 DW10707/1 0300005 10707/1 RX94807732 WY3DD107071
2	375427	0-90	1	1CO	15	6.5	95	1500	1440	-	Project	30510
2	390193	0-90	1	1CO	16	6.5	95	1500	1500	-	Angelo-Po Hoonved Rosinox	32V1920 25421 RX94801099
3	390022	30-90	1	1CO	16	9.5	50	1000	1000	19	Comenda Hoonved Mareno	120522 H120522 120522
4	390713	30-90	1	1NC	16	6	98	900	-	18	Inomak	34500040100152
5	390978 ¹	40-210	1	1CO	16	5	128	930	-	20	Silanos	TR0441
5	375992	0-90	1	1CO	15	6.5	100	3000	3000	-	GAM Krupps	KR103345 103345

¹incl. knob
Table continues overleaf

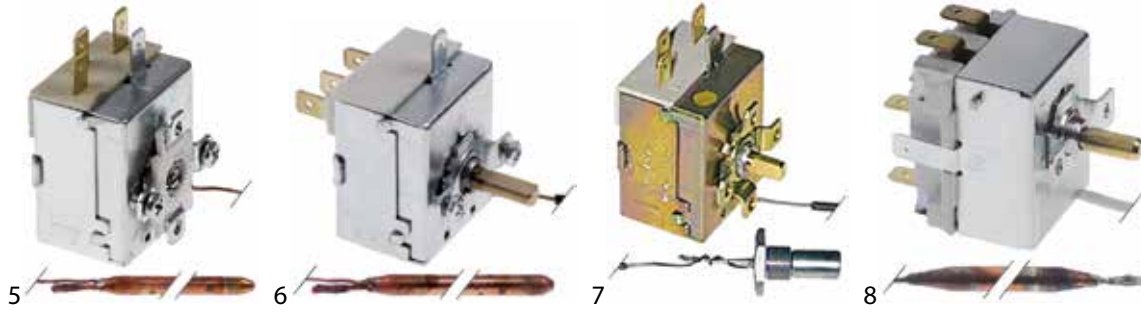

fig.	vare nr.	t.range (°C)	NP (-pole)	function	SC (A)	probe ø (mm)	probe L (mm)	cap. (mm)	cap.ins. (mm)	shaft L (mm)	suitable for	Ref. No.
5	390421	0-90	1	1CO	16	6.5	95	1500	1450	-	Angelo-Po Aristarco ATA Bartscher Bonnet Colged Dihr EGO Elettrobar Fabar Kromo Krupps Modular Rosinox	32Z7200 00000359 7608 0236027 5508E DRT13B DW15621 51.11999.160 929107 14197 DW15621 359 461.016.00 old version RX94803103
5	390457	0-90	1	1CO	16	6.5	110	1000	950	19	NuovaSimonelli Omniwash Rancilio	18010043 CETB85 34200047
5	390186	fixed 52	1	1CO	16	6.5	95	1000	1000	-	Bourgeois NuovaSimonelli OEM Omniwash Palux	REGU010 18010042 ED002 CETV55 208442
5	390314	fixed 60	-	1CO	15	6.5	95	2000	1950	-	Bonnet Rosinox Thirode	2001895H RX94803095 2001895H
5	390812	fixes 87	1	1CO	16	6.5	97	1500	-	-	Comenda Rosinox	120530 RX94807732
6	375848	-	1	1CO	16	3	200	1540	-	19	VEMA	XRPV3
6	390192	0-90	1	1CO	16	6.5	95	2000	2000	19	Dihr Hoonved Kromo Mach	DW10707/2 25417 DW10707/2 500000100
6	375920	0-90	1	1CO	16	6.5	98	1030	970	16	Univer-Bar	4044
6	390014	40-78 / 47-85	2	2CO	16	6.5	95	1500	1450	15	Comenda Hoonved Mareno	120525 H120525 120525
7	375318	0-90	1	1CO	15	11	36	600	550	19	CF-Cenedese Tecnoinox	63.7.0655 RC00238000
7	375564	0-90	1	1CO	15	11	36	600	600	19	Offcar	843791
7	390005	25-85	1	1CO	15	11	35	600	600	8	Electrolux Elettrobar MBM-Italia Rancilio Zanussi	069423 236014 236014 65236014 069423
8	390736	37-76 / 46-85	2	2CO	16	6.5	84	920	845	15	Hoonved	120525/1

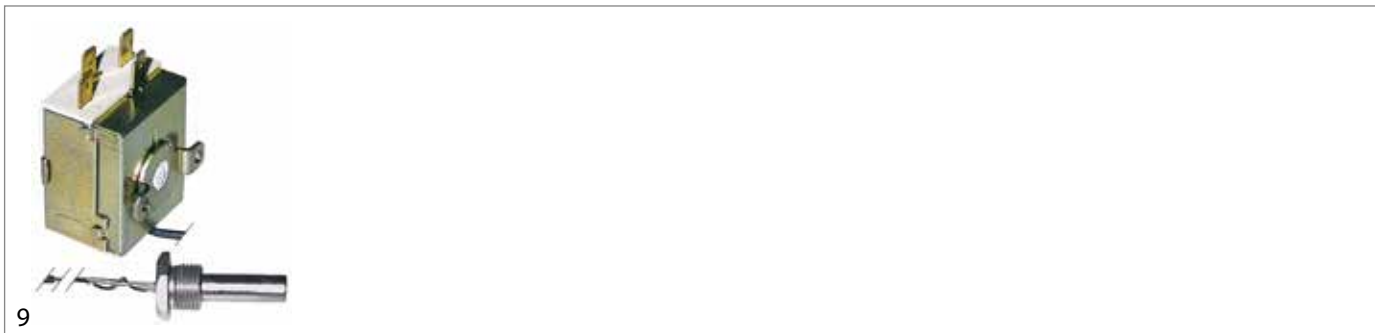

fig.	vare nr.	t.range (°C)	NP (-pole)	function	SC (A)	probe ø (mm)	probe L (mm)	cap. (mm)	cap.ins. (mm)	shaft L (mm)	suitable for	Ref. No.
9	390310	fixed 55	1	1CO	16	9.5	37	600	540	-	Angelo-Po Capic Silanos Whirlpool	32V2630 L455065 907124 483286008151
9	390913	fixed 55	1	1CO	16	11	22	600	600		Hobart	E236042
9	390425	fixed 60	1	1CO	16	9.5	37	600	600	-	Bonnet Elettrobar Rosinox	5868E DRT141C RX94803129

control thermostats with operation switch



fig.	vare nr.	t.max. (°C)	t.range (°C)	NP (-pole)	function	SC (A)	probe ø (mm)	probe L (mm)	cap. (mm)	cap.ins. (mm)	gland nut	shaft L (mm)	suitable for	Ref. No.
1	390139	270	63-270	1	1CO	15	3.5	195	1000	-	-	17	Bertos Fimar Sirman	30064600 CO4421 IGS460
1	390904	270	67-270	1	1CO	16	3.5	195	900	-	-	26	Aristarco	00003350
1	390905	300	76-300	1	1CO	16	3	195	1030	250	-	26	Aristarco	00003470



safety thermostats

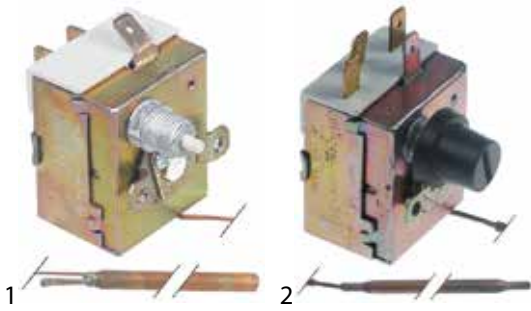

fig.	vare nr.	SOT (°C)	NP (-pole)	SC (A)	probe ø (mm)	probe L (mm)	cap. (mm)	cap.ins. (mm)	gland nut	probe	suitable for	Ref. No.
1	390601	120	1	16	6.5	93	1500	1440	-	-	Lasa	3267100
1	390458	90-110	1	16	6.5	90	2000	1950	-	-	Lamber	0300196
2	390773	135	1	16	5	130	1000	900	-	-	Comenda Hoonved Mareno	120519 H120519 120519
2	375500	140	1	15	5	125	1000	900	-	-	Modular Multi	461.071.00 150026
2	375842	238	1	0.5	5	100	1050	-	-	SS	Angelo-Po	32V4750
2	375542	238	1	15	5	100	550	-	-	SS	Forved Star10	9004 072028.1
2	390023	90-110	1	16	6.5	90	1000	-	-	-	Angelo-Po Fabar Rosinox Silanos	32Z8830 14197A RX94813555 907125
2	390770	90-110	1	16/0.5	6.5	90	2000	1950	-	-	ATA Bonnet Colged Elettrobar Rosinox Thirode	13121 2002136H 927057 927057 RX94803137 2002136H

CAEM

control thermostats

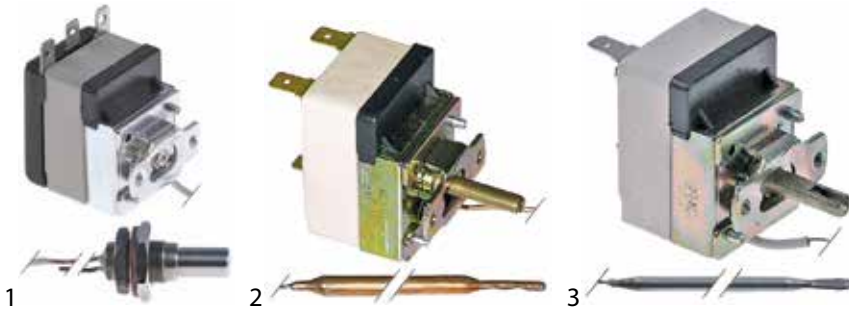

fig.	vare nr.	t.max. (°C)	t.range (°C)	NP (-pole)	function	SC (A)	probe ø (mm)	probe L (mm)	cap. (mm)	cap.ins. (mm)	gland nut	shaft L (mm)	suitable for	Ref. No.
1	390672	53	fixed 53	1	1CO	16	9.5	30	600	540	-	-	Colged Cookmax Krefft Marels MBM-Italia Modular Rancilio	236042 236042 62-236042 46101500 236042 46101500 65236042
2	375609	90	30-90	1	1CO	16	6	95	1600	1550	-	-	Inoxtrend	C2185-00
2	390082	100	30-90	1	1CO	16	6	94	1600	-	-	22	Cookmax Emmepi RM-Gastro	40250110 807256 40250110
2	375645	100	30-120	1	1CO	16	6	110	1600	1550	-	22	Bertos	25064500
2	375094	110	30-110	1	1CO	16	6	75	1600	-	-	22	Bertos Emmepi	31290500 828838
3	390604	110	30-110	1	1NO	16	5	90	970	28	-	17	Cookmax RM-Gastro	402501500 402501500

Table continues overleaf



fig.	vare nr.	t.max. (°C)	t.range (°C)	NP (-pole)	function	SC (A)	probe ø (mm)	probe L (mm)	cap. (mm)	cap.ins. (mm)	gland nut	shaft L (mm)	suitable for	Ref. No.
3	390882	120	30-120	1	1NO	16	5	80	980	28	-	17	Cookmax RM-Gastro	402501501 402501501
3	390611	150	50-190	1	1NO	16	3	185	980	640	-	23	Cookmax RM-Gastro	402502000 402502000
3	390606	300	50-300	1	1NO	16	3	200	1500	650	-	18	Cookmax RM-Gastro	402503150 402503150
3	390602	300	50-300	1	1NO	16	5	80	970	650	-	18	Bartscher Cookmax RM-Gastro	A0402503000 402503000 402503000
3	390790	300	50-280	1	1NO	16	3	160	1450	650	-	22	Bake-Off Bakers Pride	182500044 182500044

safety thermostats

fig.	vare nr.	SOT (°C)	NP (-pole)	SC (A)	probe ø (mm)	probe L (mm)	cap. (mm)	cap.ins. (mm)	gland nut	probe	suitable for	Ref. No.
1	390594	95	1	16	6	80	1550	-	-	SS	Ascobloc	09/3585
1	390874	123	1	16	3	200	920	770	-	SS	MBM-Italia	RTFOC00173
1	390603	130	1	16	5	120	900	-	-	SS	Cookmax RM-Gastro	402511130 402511130
1	375597	335	1	16	5	80	900	-	-	SS	Tecnoeka	01201190
2	390877	225	1	16	5	80	900	400	M10x1	SS	Bourgeois Solymac	THER3004 P1006
2	375996	225	1	16	5	80	900	410	M10	SS	MBM-Italia	RIC0004363
3	376043	335	1	16	3	180	970	780	-	SS	Bake-Off	182500035
4	375456	335	2	20	3	200	1050	650	-	SS	Cookmax Sogeco Tecnoeka Unox	TR254 03-TRS-350 01200400 KTR1134A

5														
fig.	vare nr.	SOT (°C)	NP (-pole)	SC (A)	probe ø (mm)	probe L (mm)	cap. (mm)	cap.ins. (mm)	gland nut	probe	suitable for	Ref. No.		
5	390962	350	1	16	6	78	900	650	M10x1	SS	MBM-Italia	177060		



JUMO

control thermostats

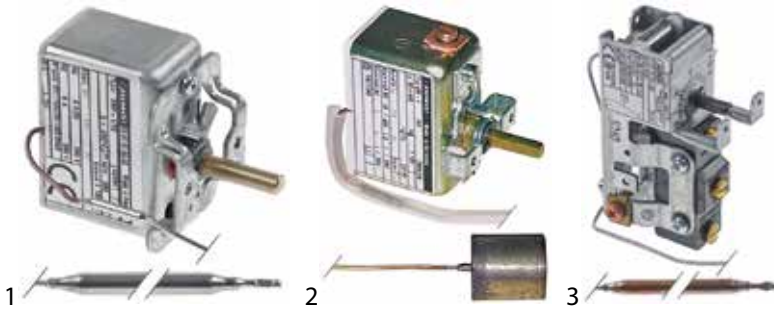

fig.	vare nr.	t.max. (°C)	t.range (°C)	NP (-pole)	function	SC (A)	probe ø (mm)	probe L (mm)	cap. (mm)	cap.ins. (mm)	gland nut	shaft L (mm)	suitable for	Ref. No.
1	376012	200	0-200	1	1CO	6	6	114	1000	-	-	13	Rosinox	RX94016573
1	375141	300	50-300	1	1CO	16	6	85	1000	-	-	19	—	—
1	375100	500	20-500	1	1CO	16	8	155	1000	-	-	17	Pizza-Group	5320470
1	375103	500	20-500	3	3CO	16	8	155	1000	-	-	17	GGF Pizza-Group Tornati	thermo003 A88TX85003 333003
1	376013	400	20-400	1	1CO	6	8	138	1450	-	-	18	Rosinox	RX94016581
2	375533	440	20-440	3	3CO	10	20	21	1000	900	-	17	Ambach	5061614400
2	375105	440	20-500	1	1CO	10	20	21	1000	900	-	17	Ambach	5061608296
3	390912 ¹	500	20-500	1	1CO	10	6	125	1500	-	-	16	MIWE	504016.02

¹with accessories

safety thermostats

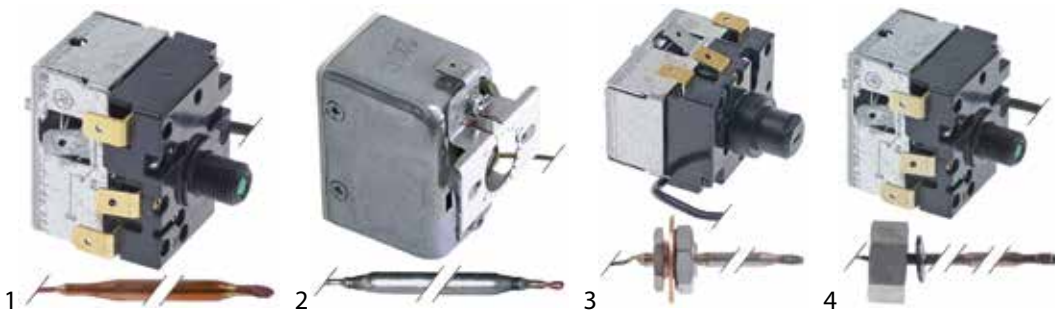

fig.	vare nr.	SOT (°C)	NP (-pole)	SC (A)	probe ø (mm)	probe L (mm)	cap. (mm)	cap.ins. (mm)	gland nut	probe	suitable for	Ref. No.
1	390922	140	1	16	5	96	990	880	-	copper	Retigo	EA04-0011
1	375741	95-120	1	16	6	75	2000	450	-	—	—	—
2	390162	50-300	1	16	6	85	1000	-	-	SS	—	—
2	390145	0-150	1	16	6	116	1000	-	-	—	—	—
2	390163	20-500	1	16	8	155	1000	-	-	—	CB	09010020
3	370763	350	1	2.5	5	48	950	500	-	SS	Hounö	30820046
4	390923	365	1	16	4	107	1190	1015	-	—	Retigo	EA04-0012



fig.	vare nr.	SOT (°C)	NP (-pole)	SC (A)	probe ø (mm)	probe L (mm)	cap. (mm)	cap.ins. (mm)	gland nut	probe	suitable for	Ref. No.
5	390169	20-500	1	16	6	275	1000	-	-	—	Moretti Tornati	74200260 333007



TECASA

control thermostats



pos.	vare nr.	t.max. (°C)	t.range (°C)	NP (-pole)	function	SC (A)	probe ø (mm)	probe L (mm)	cap. (mm)	cap.ins. (mm)	gland nut	shaft L (mm)	suitable for	Ref. No.
1	375168	55	30-55	1	1NO	16	6	105	880	-	-	16	Roller Grill	A06049
2	375448	85	30-90	1	1NO	16	6	90	2000	1950	-	23	Fagor	12034068
3	390980	90	30-90	1	1NO	16	6	95	1550	1500	-	16	Öztiryakiler	6234.00001.42
4	390500	95	0-95	1	1NO	16	6	105	900	-	-	16	Roller Grill	A06021
5	390927	110	30-110	1	1CO	16	6	91	880	850	-	18	Öztiryakiler	6234.00001.080
6	375177	170	50-170	1	1NO	16	6	75	420	210	-	15	Roller Grill	A06018
7	390975	180	50-180	1	1NO	16	5	90	620	290	-	16	Fiamma	4.0.085.0009
8	390027	190	50-190	1	1NO	16	3	145	880	680	-	-	CF-Cenedese	63.7.0640
9	375472	190	60-190	1	1NO	16	6	70	2000	490	-	23	Öztiryakiler	6234.00001.40
10	375155	230	45-230	1	1NO	16	3.1	150	530	-	-	14	Roller Grill	A06019
11	375134	280	30-280	1	1NO	16	3	170	860	-	-	14	Roller Grill	A06032
12	376028	280	50-280	1	1NO	16	3	175	1450	-	M10x1	18	Garbin	TER020
13	375909	300	50-300	1	1NO	16	3	165	870	-	-	23	Öztiryakiler	6234.00001.05

safety thermostats



pos.	vare nr.	SOT (°C)	NP (-pole)	SC (A)	probe ø (mm)	probe L (mm)	cap. (mm)	cap.ins. (mm)	gland nut	probe	suitable for	Ref. No.
1	390452	125	1	16	6	73	870	690	M9x1	SS	Fagor	12023830
2	390028	230	1	16	3	155	890	600	-	SS	Bertos CF-Cenedese VEGA	33070300 63.7.0630 93037
3	375452	230	1	16	6	52	520	70	-	SS	Roller Grill	A06001
4	376000	230	1	16	6	58	2000	490	-	SS	Öztiryakiler	6234.00001.41
5	390856	235	1	16	5	73	1030	600	-	SS	Fiamma	4.0.085.0011
6	375195	240	1	16	4	84	400	130	-	SS	Acopa Amitek Fimar VEGA	10030 R00109 CO1110 93180
7	390964	335	1	16	3	120	1500	-	M9x1	SS	Garbin	TER021



CAMPINI

control thermostats



fig.	vare nr.	t.max. (°C)	t.range (°C)	NP (-pole)	function	SC (A)	probe ø (mm)	probe L (mm)	cap. (mm)	cap.ins. (mm)	gland nut	shaft L (mm)
1	390465	90	0-90	1	1CO	16	6.5	87	1470	1450	-	-
2	375838	124	-	1	1CO	16	6	70	1970	1970	-	-
3	375816	270	50-270	1	-	-	3	135	1450	-	-	-
3	375934	280	50-280	1	1NO	16	3	185	960	700	-	23
3	375919	292	50-292	1	1NO	16	3	170	970	970	-	33

safety thermostats



fig.	vare nr.	SOT (°C)	NP (-pole)	SC (A)	probe ø (mm)	probe L (mm)	cap. (mm)	cap.ins. (mm)	gland nut	probe
1	375892	318	1	16	3	137	1260	710	-	SS

COTHERM



fig.	vare nr.	t.max. (°C)	t.range (°C)	NP (-pole)	function	SC (A)	probe ø (mm)	probe L (mm)	cap. (mm)	cap.ins. (mm)	gland nut	shaft L (mm)	suitable for	Ref. No.
1	375513	106	-	1	1NC	20	2.3	10	300	-	-	-	Animo	02929
2	390726	300	35-300	1	1NO	20	3	180	1000	-	-	16	Simogas	ELP-30.17
3	390440	-	-	1	1NC	25	3	130	1720	-	-	-	Bourgeois	THER014



INVENSYS / ROBERTSHAW

control thermostats

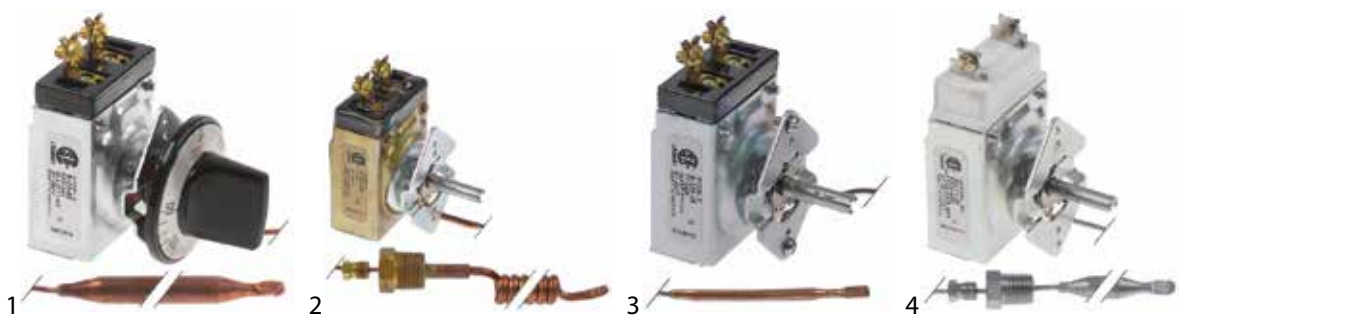

fig.	vare nr.	t.max. (°C)	t.range (°C)	NP (-pole)	function	SC (A)	probe ø (mm)	probe L (mm)	cap. (mm)	cap.ins. (mm)	gland nut	shaft L (mm)	suitable for	Ref. No.
1	376035	121	15.5-121	1	1NO	-	8.4	98	1130	-	-	20	Henny-Penny Robertshaw	50016 5300-04A
2	390863	142	0-142	1	1NO	25	13	230	1200	-	3/8" NPT	24	Falcon Robertshaw	736009730 K-153-48
3	390838	190	90-190	1	1NO	0.67	9.5	95	900	-	1/4"	23	Falcon Robertshaw	535710029 RX-19-36
3	390971	190.6	93-190	1	1NO	0.67	9.5	120	870	-	3/8" NPT	23	Pitco	60125402
3	390875	232.2		1	1NO	30	5	280	900	-	-	24	AltoShaam Robertshaw	TT-3498 S-335-36
3	390835	287	93-287	1	1NO	30	4.6	290	1200	-	-	23	Falcon Robertshaw	730962080 EA5P-485-48
3	390837	287	93-287	1	1NO	30	4.7	290	1200	-	-	23	Falcon Robertshaw	731880190 EA5-24-48
4	376001	190	94-190	1	1NO	0.67	9.5	125	900	-	1/4" NPT	23.5	—	—



fig.	vare nr.	t.max. (°C)	t.range (°C)	NP (-pole)	function	SC (A)	probe ø (mm)	probe L (mm)	cap. (mm)	cap.ins. (mm)	gland nut	shaft L (mm)	suitable for	Ref. No.
5	376042	191		1	1NO	-	8	124	590	-	-	24	Frymaster	8262014
6	390636	204	93-204	1	1NO	0.67	9.5	123	915	-	1/4" NPT	21	American Dryer Anets Frymaster Imperial-Germany Imperial-USA OEM Pitco Robertshaw Tri-Star	A50400 P8905-03 807-3515 1175 1175 P8905-03 60125401 RX-1-36 300232
7	376034	204	93-204	1	1NO	-	8	128	570	-	5/16" UNF	20	Henny-Penny Robertshaw	14293 5300-76F
8	580040	205	94-205	1	1NO	-	9.5	123	885	-	3/8" NPT	-	Pitco Robertshaw	P5047587 EA3-44-36
9	376038	232	12-232	1	1NO	25	6.5	173	870	-	-	20	Garland Robertshaw	G0893-01 K-1139-36
9	376036	314	38-314	1	1NO		5	285	1750	-	-	20	Garland Robertshaw	1611900 KX-410-72



fig.	vare nr.	t.max. (°C)	t.range (°C)	NP (-pole)	function	SC (A)	probe ø (mm)	probe L (mm)	cap. (mm)	cap.ins. (mm)	gland nut	shaft L (mm)	suitable for	Ref. No.
10	376044	232	37-232	2	2NO	30	6.5	172	1045			24	Garland Robertshaw	1102703 D1H20420400
11	376032	260	60-260	1	1NO		5	286	900	-	-	20	Blodgett Garland Robertshaw	16536 1032499 5300-76C
12	376033	260	64-260	1	1NO		5	285	1045	-	-	20	Garland Robertshaw	G02902-01 KX-431-42
12	376037	288	65-288	1	1NO		5	286	1010	255	-	20	Garland Robertshaw U.S. Range	G0894-01 5300-17k 1032400
13	390637	260	93-260	1	1NO	-	4.5	310	900	-	-	32.5	Imperial-USA Robertshaw	1160 KXT-466-36
14	376030	288	38-288	2	2NO	30	5	295	1540	-	-	20	Bakers Pride Garland Robertshaw	M1032X 1010300 5000-851
14	376031	371	148-371	2	2NO	30	5	285	1540	-	-	20	Bakers Pride Garland Robertshaw	M1031X 1010304 5000-601

safety thermostats



fig.	vare nr.	SOT (°C)	NP (-pole)	SC (A)	probe ø (mm)	probe L (mm)	cap. (mm)	cap.ins. (mm)	gland nut	probe	suitable for	Ref. No.
1	390966	121	1	-	6.4	136	610	-	1/4" NPT	SS	Pitco Robertshaw	60070701 LCHBC0240000
1	390861	129.5	1	-	6.3	133	600	-	1/4" NPT	SS	Falcon	736094161
1	390638	218	1	-	8	77	940	-	1/4" NPT	SS	Imperial-USA Robertshaw	33497 LCCM210360000
1	390967	224	1	-	6.4	118	790	-	-	SS	Pitco Robertshaw	PP11010 LCCG70300000
1	580045	232	1	-	6.4	120	760	-	3/8" NPT	SS	Nayati Pitco Robertshaw	GS.2183 PP10084 LCHM050300000
1	390639	232	1	-	7.9	77	914	-	3/8" NPT	SS	Imperial-Germany Imperial-USA Robertshaw	1177 1177 LCCM080360000
1	390965	232	1	-	7.93	77	760	-	-	SS	Pitco Robertshaw	P5047216 LCH370300000
2	580076	218	1	-	4.8	180	630	-	3/8" NPT	SS	Robertshaw	LCHB80240000



JAEGER

control thermostats



fig.	vare nr.	t.max. (°C)	t.range (°C)	NP (-pole)	function	SC (A)	probe ø (mm)	probe L (mm)	cap. (mm)	cap.ins. (mm)	gland nut	shaft L (mm)	suitable for	Ref. No.
1	375224	184	35-188	1	1NO	16	3	165	520	270	-	20	EGO	55.13039.390

PRODIGY / FIRT

control thermostats

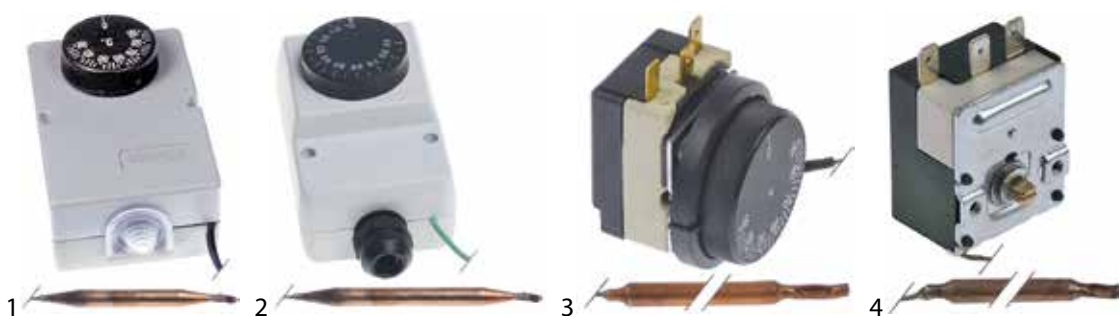

fig.	vare nr.	t.range (°C)	NP (-pole)	function	probe ø (mm)	probe L (mm)	cap. (mm)	cap.ins. (mm)	suitable for	Ref. No.
1	390595	30-90			6.5	63	1500		Franke Friulinox	995574 FR995574
2	390733	30-90	1	-	6.5	85	1350	1325	Lamber	0300270
3	390822	30-90	1	1CO	6.5	67	1450	70	—	—
3	375475	30-120	1	1CO	6	105	1480	100	Tecfrigo	A0103
4	390626	-	1	1CO	6	72	700	-	Vibiemme	ELETTEDOM
4	390723	-35 up to +35			6	110	1500		—	—

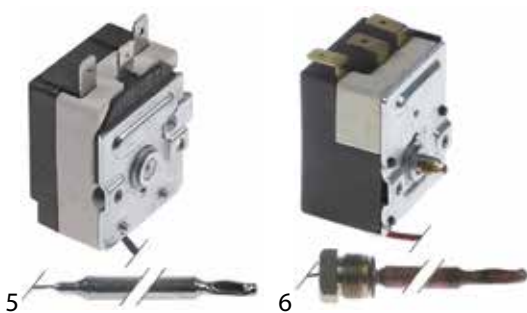

fig.	vare nr.	t.range (°C)	NP (-pole)	function	probe ø (mm)	probe L (mm)	cap. (mm)	cap.ins. (mm)	suitable for	Ref. No.
5	390686	-	1	1CO	6	110	650	550	Colged Cookmax Elettrobar Hobart Krefft Rancilio	236043 236043 236043 236043 62-236043 65236043
6	390716	-	1	1CO	6.5	90	1700	1500	Vibiemme	ELETTEDOMJU2B



control thermostats with operation switch

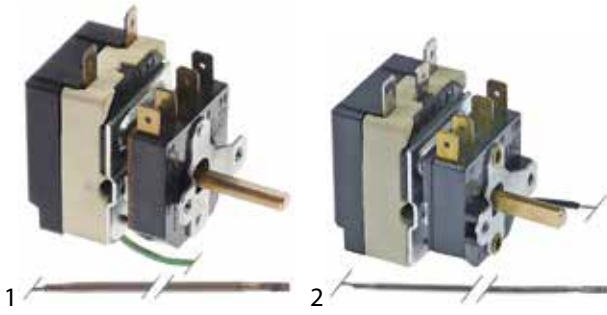

fig.	vare nr.	t.range (°C)	NP (-pole)	function	SC (A)	probe ø (mm)	probe L (mm)	cap. (mm)	cap.ins. (mm)	shaft L (mm)	shaft position (°)	RA (°)	outer switch	suitable for	Ref. No.
1	420445	50-300	1	1NO	16	3	190	1015	795	24	-	270	2NO	Gierre	TER123
2	390791	63-270	1	1CO	16	3	185	950	55	16.5		270	2NO	CF-Cenedese	63.7.0651

safety thermostats

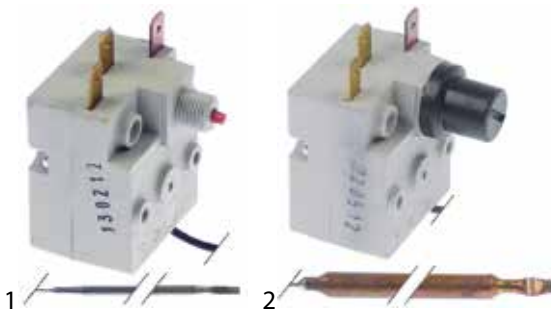

fig.	vare nr.	SOT (°C)	NP (-pole)	function	SC (A)	probe ø (mm)	probe L (mm)	cap. (mm)	cap.ins. (mm)	gland nut	probe	suitable for	Ref. No.
1	375478	200	1	1CO	20	3.3	190	2150	-	-	SS	Bartscher Bonnet Capic Thirotde	0927106 2001687H L454815 2001687H
2	390823	235	1	1CO	20	6	62	1600	85	-	copper	—	—

RANCO

safety thermostats

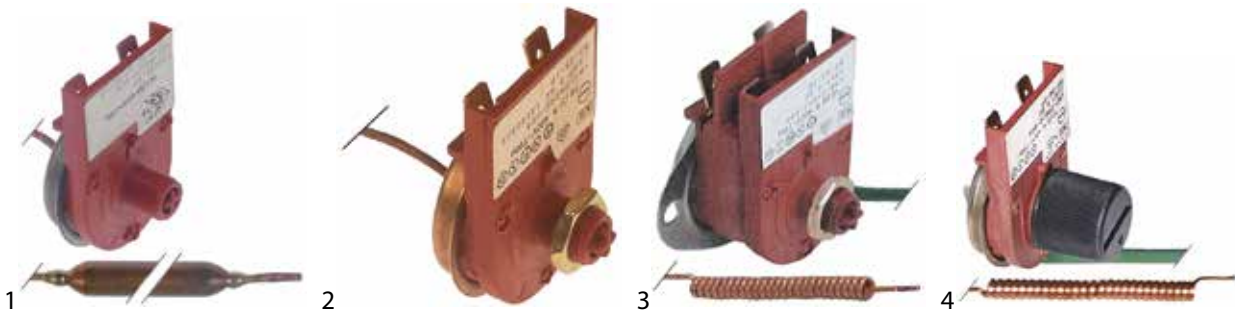

fig.	vare nr.	t.max. (°C)	t.range (°C)	NP (-pole)	function	SC (A)	probe ø (mm)	probe L (mm)	cap. (mm)	cap.ins. (mm)	gland nut	shaft L (mm)
1	375832	70	0-70	1	1NO	16	8	60	870	-	-	-
2	390583	80	-	1	1NC	16	9	50	800	-	-	-
3	390473	105	-	2	2NC	16	6	50	430	310	-	-
4	390024	110	-	1	1NC	16	6	50	1540	160	-	-

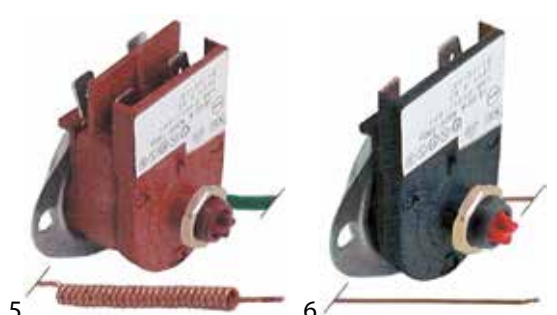



fig.	vare nr.	t.max. (°C)	t.range (°C)	NP (-pole)	function	SC (A)	probe ø (mm)	probe L (mm)	cap. (mm)	cap.ins. (mm)	gland nut	shaft L (mm)
5	390469	110	-	2	2NC	16	6	50	1540	160	-	-
6	390305	165	-	1	1NC	25	2	-	490	-	-	-

thermostats

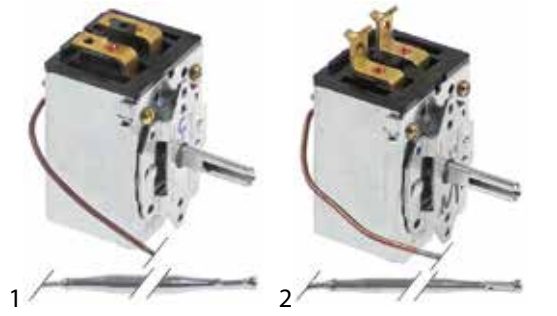

fig.	vare nr.	t.max. (°C)	t.range (°C)	NP (-pole)	function	SC (A)	probe ø (mm)	probe L (mm)	cap. (mm)	cap.ins. (mm)	gland nut	shaft L (mm)
1	376040	204	65-204	1	1NO	-	6	165	930	-	-	24
2	376041	232	65-232	1	1NO	-	5	324	1540	-	-	24
2	376039	260	65-260	1	1NO	-	4.8	320	925	-	-	24

RATHGEBER

control thermostats

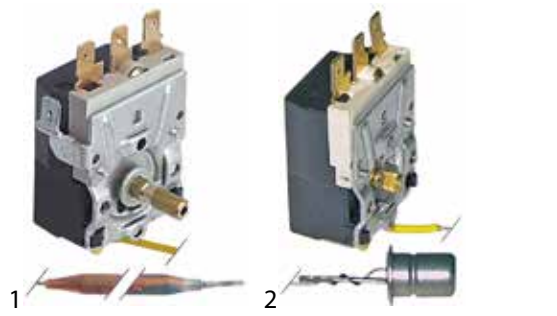

fig.	vare nr.	t.max. (°C)	t.range (°C)	NP (-pole)	function	SC (A)	probe ø (mm)	probe L (mm)	cap. (mm)	cap.ins. (mm)	gland nut	shaft L (mm)	suitable for	Ref. No.
1	390243	90	0-90	1	1CO	16	6	140	3000	50	-	-	Meiko	0108041
1	390127	95	0-95	1	1CO	16	6	145	480	430	-	17	Meiko	0108036
1	390242	95	0-95	1	1CO	16	6	150	480	420	-	-	Meiko	0108037
1	390131	95	0-95	1	1CO	16	8	135	880	850	-	-	—	—
1	375702	110	30-110	1	1NO	16	6	140	2400	1700	-	17	Electrolux Rieber	0KA778 33060401
1	375739	110	30-110	1	1NO	16	6	140	1600	1560	-	24	Rieber	33060301
1	375736	150	50-150	1	1CO	16	6	90	1450	700	M9x1	23	Rieber	33061903
2	390130	95	0-95	1	1CO	16	15	17	450	50	-	-	—	—



control thermostats with operation switch



fig.	vare nr.	t.range (°C)	NP (-pole)	function	SC (A)	probe ø (mm)	probe L (mm)	cap. (mm)	cap.ins. (mm)	shaft L (mm)	suitable for	Ref. No.
1	375931	30-110	1	1NC	16	6	140	860	65	26.5	Jünger	422111
1	375738	30-110	1	1NO	16	6	140	1650	1400	17	Rieber	33061801

STIEBEL-ELTRON



fig.	vare nr.	SOT (°C)	t.range (°C)	NP (-pole)	function	SC (A)	probe ø (mm)	probe L (mm)	cap. (mm)	cap.ins. (mm)	gland nut
1	390393	165	-	2	2NC	25	3	340	-	-	-

various

control thermostats

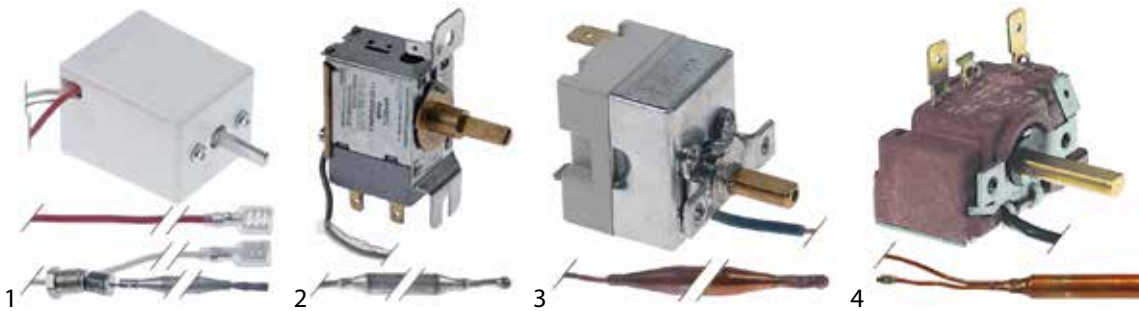

fig.	vare nr.	t.max. (°C)	t.range (°C)	NP (-pole)	function	SC (A)	probe ø (mm)	probe L (mm)	cap. (mm)	cap.ins. (mm)	gland nut	shaft L (mm)	suitable for	Ref. No.
1	390864 ¹			1	1NO	-	6	110	1445	-	M9x1		Falcon	535670014
1	390865 ¹	190	48-190	1	1NO	-	6	110	1445	-	M9x1	22	Falcon	537350034
2	390785	90	0-90	1	1NO	6	6	95	550	490	-	23.5	Horeca-Select	GGC1078-5
2	390871	95	0-95	1	1NO	6	6	95	550	490	-	23	Horeca-Select	GGC1078-5
3	375904	90	0-90	1	1NO	16	6.5	85	970	-	-	15	Cookmax Sirman	IB5866000 IB5866000
4	375759	95	35-95	1	1NO	16	6	68	910	860	-	22	Abner	M113109

¹with accessories



fig.	vare nr.	t.max. (°C)	t.range (°C)	NP (-pole)	function	SC (A)	probe ø (mm)	probe L (mm)	cap. (mm)	cap.ins. (mm)	gland nut	shaft L (mm)	suitable for	Ref. No.
5	375761	115	20-115	1	1NO	16	4	120	1600	130	-	15	Blanco	105678
6	390968	185	-	2	1NO	16	6	77	1500	-	-	25	Hualing	HDF1108-18
7	390842 ¹	250	100-250	1	1NO	-	4	133	1300	950	-	23	Falcon	531740350
8	375914	290	50-290	1	1NO	-	3	165	1040	600	-	23	Piron	TER30018
9	375935	320	50-320	1	1NO	15	3	155	1030	100	-	23	Lainox	LAR65070400

¹with accessories

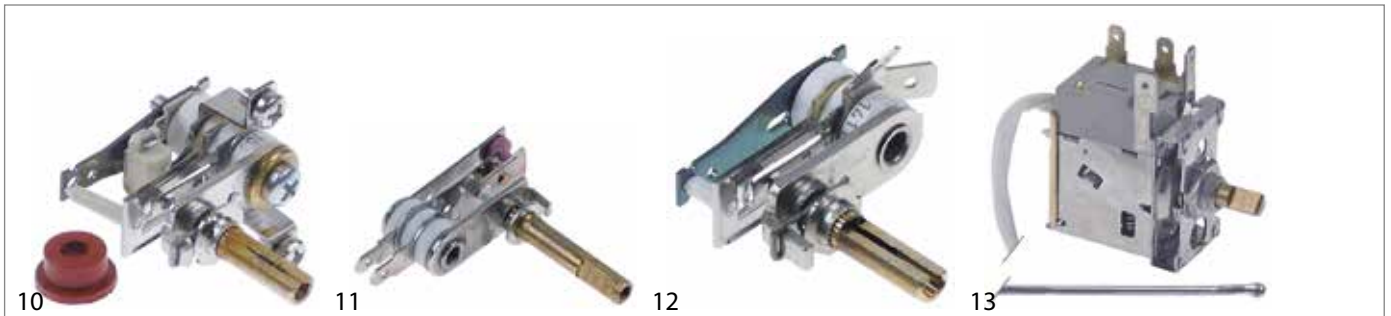

fig.	vare nr.	t.max. (°C)	t.range (°C)	NP (-pole)	function	SC (A)	probe ø (mm)	probe L (mm)	cap. (mm)	cap.ins. (mm)	gland nut	shaft L (mm)	suitable for	Ref. No.
10	390826	-	-	1	-	-	-	-	-	-	-	16	Grandimpianti	1020089
11	390622	-	-	1	1NC	10	-	-	-	-	-	30	Bartscher Cookmax	01143566 01143566
12	375924	-	-	1	1NC	-	-	-	-	-	-	17	Silex	05 010 030
13	390855	-	-	1	1NO	5	2	-	750	250	-	12	Horeca-Select	GHR1040-14
13	390870	-	-	1	1NO	5	2	-	750	250	-	12	Horeca-Select	GHR1040-14

safety thermostats

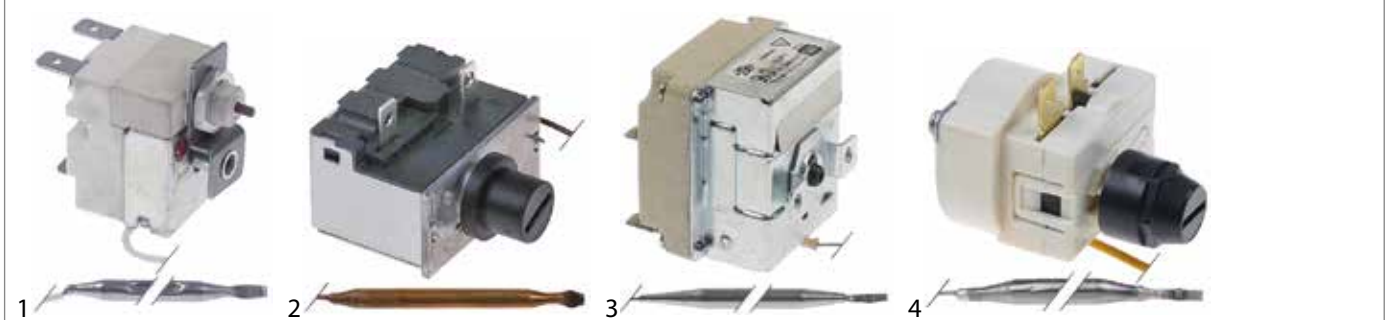

fig.	vare nr.	SOT (°C)	NP (-pole)	SC (A)	probe ø (mm)	probe L (mm)	cap. (mm)	cap.ins. (mm)	gland nut	probe	suitable for	Ref. No.
1	390908	124	1	16	6	71	2000	2000	-	SS	Electrolux	0HA200
2	375637	135	1	16	6	75	600	-	-	copper	Baron Olis	0A046185 BN6A046185
3	376045	140	-	16	6	112	410	20	-	-	Conti	415526
4	375932	146	1	-	6	86	850	50	-	SS	Jünger	422211





fig.	vare nr.	SOT (°C)	NP (-pole)	SC (A)	probe ø (mm)	probe L (mm)	cap. (mm)	cap.ins. (mm)	gland nut	probe	suitable for	Ref. No.
5	375501	169	1	16	3	160	88	80	-	SS	QualityEspresso	08324600
6	375523	230	1	16	4	100	900	410	-	-	Bartscher	016240438
6	390970	230	2	16	5	48	440	150	-	-	Hualing	GDF1104-5
7	370766	240	1	16	3.9	93	610	80	-	SS	—	—
8	390607	360	1	20	3	150	920	240	-	SS	Cookmax RM-Gastro	402511200 402511200



fig.	vare nr.	SOT (°C)	NP (-pole)	SC (A)	probe ø (mm)	probe L (mm)	cap. (mm)	cap.ins. (mm)	gland nut	probe	suitable for	Ref. No.
9	390839 ¹	-	1	-	6	78	700	-	M9x1	SS	Falcon	537350031
10	390840 ¹	-	1	-	6	78	700	-	M9x1	SS	Falcon	537350030
11	390841 ¹	-	1	-	6	78	700	-	M9x1	SS	Falcon	536300036

¹with accessories

control thermostats with actual value display



fig.	vare nr.	t.max. (°C)	t.range (°C)	function	SC (A)	probe ø (mm)	cap. (mm)	mounting ø (mm)	fig.	vare nr.	t.max. (°C)	t.range (°C)	function	SC (A)	probe ø (mm)	cap. (mm)	mounting ø (mm)
1	379031	40	-40 up to +40	1CO	10	8	1650	60	3	379035	120	0-120	1CO	5	10	1500	80
2	379032	120	0-120	1CO	5	8	1500	60	4	379914	120	0-120	1CO	10	12	1200	60



fig.	vare nr.	t.max. (°C)	t.range (°C)	function	SC (A)	probe ø (mm)	cap. (mm)	mounting ø (mm)	fig.	vare nr.	t.max. (°C)	t.range (°C)	function	SC (A)	probe ø (mm)	cap. (mm)	mounting ø (mm)
5	379844	320	0-320	1CO	10	8	1530		7	379034	450	50-450	1CO	5	6	1150	80
6	379039	400	0-400	1CO	5	8	1100	60									

remote thermostats

DANFOSS

coiled remote probes

pos.	vare nr.	t.range (°C)	difference low range (°C)	difference high range (°C)	probe ø (mm)	probe L (mm)	cap. (mm)
1	390487	-30 up to +15	5.5-23	1.5-7	9.5	70	2000
2	390489	-5 up to +35	4.5-25	1.8-7	9.5	70	2000

RANCO

straight remote probes

pos.	vare nr.	t.range (°C)	difference low range (°C)	difference high range (°C)	probe ø (mm)	probe L (mm)	cap. (mm)
1	390333	-34 up to +32	8-22	4.0/25	9.5	150	1800
2	390337	-5 up to +25	1.7-7	3-12	14.5	140	1800



coiled remote probes



pos.	vare nr.	t.range (°C)	difference low range (°C)	difference high range (°C)	probe ø (mm)	probe L (mm)	cap. (mm)
1	390335	-18 up to +13	1.7-7	3-12	9.5	38	2000
2	390336	-5 up to +25	1.7-7	3-12	9.5	38	2000

room thermostats

DANFOSS



pos.	vare nr.	type	t.range (°C)	difference low range (°C)	difference high range (°C)
1	390494	KP 62	-30 up to +15	6-23	1.5-7

RANCO



pos.	vare nr.	t.range (°C)	difference low range (°C)	difference high range (°C)	pos.	vare nr.	t.range (°C)	difference low range (°C)	difference high range (°C)
1	390881	+10 up to +40	-	-	2	390330	-18 up to +13	fixed 1	fixed 1.5

rod thermostats

safety rod thermostats

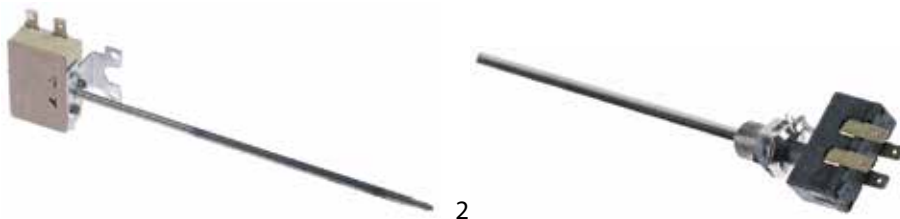

fig.	vare nr.	t.range (°C)	NP (-pole)	function	SC (A)	probe ø (mm)	probe L (mm)	cap. (mm)	cap.ins. (mm)	gland nut	shaft ø (mm)
1	390880	-	2	1NC/1NO	-	4	170	-	-	-	-
2	390433	0-145	2	2NC	20	8	187	-	-	-	-



rod thermostats



fig.	vare nr.	t.range (°C)	function	NP (-pole)	SC (A)	probe ø (mm)	probe L (mm)	volt. (V)
1	390497	0-90	1CO	1	16	8	85	250
2	390498	0-90	1CO	1	16	8	200	250
3	390368	38 to 148°C/-4 to +107	1NO/1NC	1	15	15.7	91	125-250VAC

refrigeration thermostats

straight remote probes

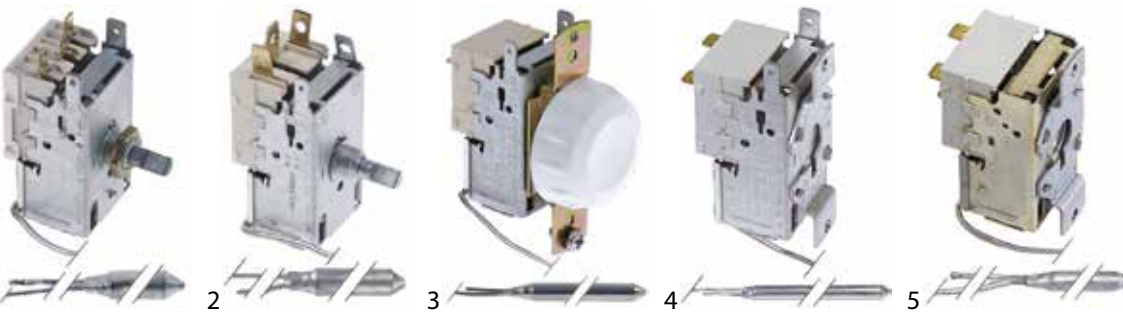

fig.	vare nr.	t.range (°C)	probe ø (mm)	probe L (mm)	cap. (mm)	type	fig.	vare nr.	t.range (°C)	probe ø (mm)	probe L (mm)	cap. (mm)	type
1	390618	-40 up to +40	9.5	107	1950	K57L2865	4	390283	-	10	110	1100	K55L5081
2	390876	-	9.6	130	2060	K22L8100	5	390284	-	10	110	1500	K55L5082
3	390253	-	9.7	107	1110	K55L1047	5	390274	-5 up to +13	10	100	2000	K22L2554

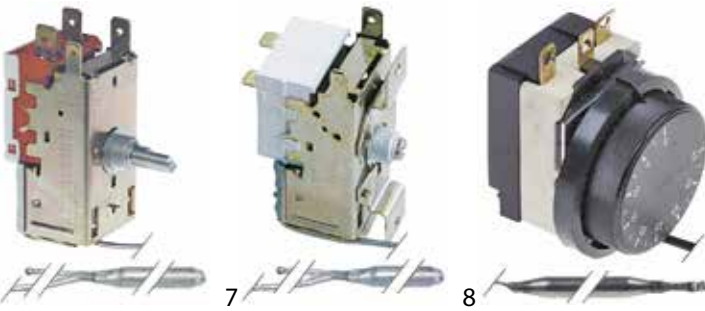

fig.	vare nr.	t.range (°C)	probe ø (mm)	probe L (mm)	cap. (mm)	type	fig.	vare nr.	t.range (°C)	probe ø (mm)	probe L (mm)	cap. (mm)	type
6	390273	+1 up to +3	10	40	1870	K50L3194	8	390535	0 up to +40	6	110	1500	PRODIGY
7	390210	+1.7 up to +9.5	10	110	1100	K55L1042	8	390010	-35 up to +35	6	110	1500	IMPORT
8	390673	0 up to +40	6	110	1500	IMPORT	8	390534	-35 up to +35	6	110	1800	PRODIGY



coiled remote probes



pos.	vare nr.	t.range (°C)	probe ø (mm)	probe L (mm)	cap. (mm)	type	suitable for	Ref. No.
1	390506	-	8	120	-	-	Philips Whirlpool	481927128579 481927128579
2	390737	-	9	42	1450	-	Angelo-Po Icematic Ranco Scotsman	32V4400 NX62020101 K22-L1074 62020101
3	390972	-	10	24	660	-	Dukers Horeca-Select	HSC360-37 HSC360-37
4	390547	-	10	48	1500	K50H2005	Ranco	K50-H2005
5	390280	-14 up to -9	9	35	1600	K22L3021	GIGA Ranco Scotsman	I62012500 K22-L3021 62012500
6	390209	-14.5 up to 20.5	9	40	2000	K22L1020	Electrolux GIGA Icematic Ranco Scotsman Simag	086033 I62020100 19797009/0 K22-L1020 62020100 62020100
7	390539	-2 up to +8	-	-	2000	K22L3521	Electrolux Ranco Zanussi	099551 K22-L3521 0A8963
8	390277	-26.5 up to -19.5	9	40	1600	K22L3020	GIGA Ranco Scotsman	I63003800 K22-L3020 63003800
9	390214	-6.4 up to +3.2	11	30	2100	K52L4512	Angelo-Po Electrolux Ranco Zanussi	32Z0920 0A8653 K52-L4512 0A8653

capillary probes



pos.	vare nr.	probe ø (mm)	probe L (mm)	cap. (mm)	type	suitable for	Ref. No.
1	390849	1.9	-	1200	K50-L3231/002	Cornelius Sencotel S.L. SPM Staff Ice System	04.BA0031.001 SL37AAL3231 04.BA0031.001 SL37AAL3231
2	390211	2	20	700	-	Philips Whirlpool	481927128578 481927128578
3	390873	2	-	1000	K54-L1870	—	—
4	390872	2	-	1200	K50-L3421	Ranco Tefcold	K50-L3421 1022600019

Table continues overleaf



pos.	vare nr.	probe ø (mm)	probe L (mm)	cap. (mm)	type	suitable for	Ref. No.
5	390642	2	-	1230	K50-L3218	Eliwell Eliwell Icematic Ranco SF-Maschinen Ugolini	K50L3218 K50L3218000 19797019/0 K50-L3218 I-1058 21087-00000
6	390757	2	-	1500	K50-L3337	IARP Ranco	0225090 K50-L3337
7	390586	2	-	1800	K61L1504	Electrolux Icematic Ranco Scotsman Zanussi	086288 19797031/0 K61-L1504 620264-11 086288
8	379516	2	-	1800	K61L1508	Icematic Ranco Scotsman Simag WEGA	CF62026416 K61-L1508 62026402 62026416 WY31F62026416
9	390669	2	-	2000	-	La-Sommeliere	7038257
10	390961	2	-	2000	K22L2082	Migel Ranco	1LT112 K22 L2082
11	390581	2	-	2000	K50L3324	Eliwell Eliwell Foster Icematic Ranco Scotsman SF-Maschinen	K50L3324 K50L3324000 15315803 19797026/0 K50-L3324 63000500 I-35
12	390960	2	-	2000	K59L1045	Migel	1LT019
13	390762	2	-	2000	WPF206B-L	Manitowoc	20-0883-3
14	390579	2	-	2250	K22L1081	Kastel Ranco	K00080 K22-L1081
15	390591	2	-	2250	K61L1509	Ranco Scotsman Simag	K61-L1509 62026415 62026415
16	390589	2	-	2300	K22L1083	Brema Electrolux NTF Ranco	R23597 087804 23597 K22-L1083
17	390760	2	-	2500	K50-L3210	IARP Ranco	3301323 K50-L3210
18	390588	2	-	3000	K50L3274	Brema Electrolux NTF Ranco	23421 089078 NR23421 K50-L3274
19	390548	2	-	1200	K50L3081	Ranco	K50-L3081
20	390932	2.5	5	1110	-	Amitek	R00081
21	390290	4.6	6	2000	K50S3493	ITV Ranco	100274 k50-S3493
22	390582	7	108	1400	K22-L1529	Icematic Ranco SF-Maschinen	19797025/0 K22-L1529 I-238
23	390212	-	-	750	K61L1500	Icematic Ranco Scotsman SF-Maschinen	29090002/0 K61-L1500 62026410 I-352
24	390677	-	-	1200	077B0028	Infrico	308X10
25	390220	-	-	1200	077B0082L	—	—
26	390577	-	-	1200	K22L2084	ITV	120273
27	390545	-	-	1200	K50P1125	Ranco	K50-P1125
28	390546	-	-	1200	K50P1127	Öztiryakiler Ranco	6268.00013.01 K50-P1127
29	390561	-	-	1200	VA102 K50-H1105	Ranco	VA102
30	390560	-	-	1200	VC101 K50-H1104	Ranco	VC101
31	390270	-	-	1250	K50L3019	Brice Italia Eurfrigor Geofrigor Ranco	RF000610 RF000610 RF000610 K50-L3019

Table continues overleaf



pos.	vare nr.	probe ø (mm)	probe L (mm)	cap. (mm)	type	suitable for	Ref. No.
32	390292	-	-	1250	K50P1118	Emmepi IME Turbo Mareno Ranco Telme	828317 TKS015 MA2523500 K50-P1118 F05.002.R
33	390552	-	-	1300	077B7001	—	—
34	390553	-	-	1300	077B7002	—	—
35	390555	-	-	1500	077B7004	—	—
36	390291	-	-	1500	K22 S1096	ITV	100153
37	390202	-	-	1500	K22L2025	Angelo-Po Ranco	32Z7450 K22-L2025
38	390278	-	-	1500	K50L3207	Angelo-Po Eliwell Eliwell Ranco	32Z6360 K50L3207 K50L3207000 K50-L3207
39	390286	-	-	1500	K50L3383	Brema Brice Italia Cookmax Electrolux Eurfrigor Geofrigor Kastel	23005 926080 23005 085283 RFS0B892 RFS0B892 K00079
40	390344	-	-	1500	K61L1505	Intimpex Ranco	0950 K61-L1505
41	390569	-	-	1500	VI112 K59-H2805	Ranco	K59-H2805
42	390554	-	-	1600	077B7003	—	—
43	390563	-	-	1600	VP104 K60-L2024	Ranco	VP104
44	390780	-	-	1800	K50-L3085	Mondial Ranco	1001086 K50-L3085
45	390206	-	-	1800	K61L1501	GIGA Ranco Scotsman	I62026400 K61-L1501 620264.00
46	390559	-	-	2000	077B7008	Electrolux Icematic Scotsman	0K8399 19797012/0 CM19797007
47	390524	-	-	2000	K22L1082	Brema Brice Italia Cookmax Electrolux Eurfrigor Geofrigor Kastel K03089 NTF Rancilio Ranco	R23591 926081 23591 087969 RFS0B893 RFS0B893 K03089 N23591 68023591 K22-L1082
48	390207	-	-	2000	K22L2030	Angelo-Po GIGA Mach Migel Ranco Scotsman Simag	32Z3890 I62026414 80001LT092 1LT020 K22-L2030 62026414 Z1EL011
49	390208	-	-	2000	K50L3006	Angelo-Po GIGA Ranco Scotsman	3034730 I620209100 K50-L3006 620209.00
50	390271	-	-	2000	K50L3078	Dexion Electrolux MBM-Italia Ranco	013475-00 0A8089 013475-00 K50-L3078

Table continues overleaf



pos.	vare nr.	probe ø (mm)	probe L (mm)	cap. (mm)	type	suitable for	Ref. No.
51	390340	-	-	2000	K50L3209	Intimpex Ranco	1068 K50-L3209
52	390285	-	-	2000	K50P1115/012	Eliwell Ranco	K50P1115012 K50-P1115
53	390272	-	-	2000	K50P1117	Dexion Electrolux IME Turbo MBM-Italia Ranco	013477-00R 0A8135 TKS014 013477-00R K50-P1117
54	390619	-	-	2000	K50P6073/001	Cookmax Liebherr Ranco	6151995 6151995 K50-P6073
55	390259	-	-	2000	K55L5026	Electrolux Eliwell Eliwell Ranco Zanussi	082025 K55L5026 K55L5026000 K55-L5026 082025
56	390275	-	-	2000	K55L5047	Friulinox Ranco	FR995385 K55-L5047
57	390250	-	-	2000	K55L5078	Electrolux Ranco	083125 K55-L5078
58	390217	-	-	2000	K55L5080	Electrolux Ranco Zanussi	083147 K55-L5080 083147
59	390617	-	-	2000	K57-L2866	Cookmax Liebherr Ranco	6151753 6151753 K57-L2866
60	390565	-	-	2000	VB107 K50-H1107	Ranco	VB107
61	390567	-	-	2000	VC110 K50-H1108	Ranco	K50-H1108
62	390566	-	-	2000	VI109 K59-H1303	Ranco	VI109
63	390564	-	-	2000	VS105 K54-H1404	Ranco	VS105
64	390288	-	-	2100	K50L3163	Brema Electrolux Eliwell Eliwell NTF Ranco	23034 085314 K50L3163 K50L3163000 NR23034 K50-L3163
65	390289	-	-	2150	K61L1502	Luxia Ranco	L4750 K61-L1502
66	390557	-	-	2300	077B7006	—	—
67	390287	-	-	2300	K61L1506	Brema Ranco	23004 K61-L1506
68	390345	-	-	2500	K22L1034	Intimpex Ranco	1006 K22-L1034
69	390201	-	-	2500	K22L2021	Ranco Simag	K22-L2021 Z1EL012
70	390254	-	-	2500	K50P1135	Angelo-Po Ranco Scotsman	32V4270 K50-P1135 62020900
71	390261	-	-	2550	K22L2557	Eliwell Eliwell Friulinox Mareno Ranco	K22L2557 K22L2557000 995352 MA2475912 K22-L2557



with housing



technical data:
probe diameter 6mm

fig.	vare nr.	t.range (°C)	probe L (mm)	cap. (mm)	producer
1	390674	0 up to +40	110	1500	IMPORT
1	390537	0 up to +40	110	1500	PRODIGY
1	390012	-35 up to +35	110	1500	IMPORT
1	390536	-35 up to +35	110	1500	PRODIGY

fig.	vare nr.	t.range (°C)	probe L (mm)	cap. (mm)	producer
2	390952	30-120	104	1300	PRODIGY
2	390011	-35 up to +35	110	-	IMPORT
2	390538	-35 up to +35	110	-	PRODIGY

miscellaneous



fig.	vare nr.	t.range (°C)	probe ø (mm)	probe L (mm)	cap. (mm)	type	suitable for	Ref. No.
1	390956	-	2	10	1500	-	Brice Italia	926136

miscellaneous



fig.	vare nr.	description
1	376025	thermostat fixed 232°C cable length mm

fig.	vare nr.	description
2	375798	thermostat Miniclic 102°C conversion kit

accessories

axis extensions



fig.	vare nr.	description	total length (mm)	Qty (pcs)
1	550142	shaft extension L1 13 mm total length 35 mm	35	1
2	551063	shaft extension L1 23 mm total length 45 mm	45	1
3	550143	shaft extension L1 18 mm total length 28 mm	28	1
3	550141	shaft extension L1 28 mm total length 38 mm	38	1

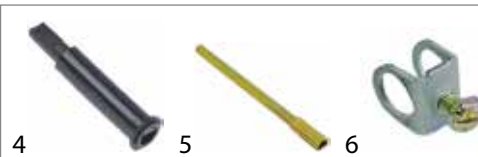

fig.	vare nr.	description	total length (mm)	Qty (pcs)
4	551121	shaft extension total length 45 mm shaft ø 6x4.6mm	45	20
4	551215	shaft extension total length 45 mm shaft ø 6x4.6mm	45	1
5	550144	shaft extension L1 80 mm total length 100 mm	100	1
6	550145	clamping bracket Qty 1 pcs ø 8,5 mm	-	1

fitting parts



fig.	vare nr.	description
1	504736	bracket for contact thermostat
2	550388	bracket for contact thermostat
3	550389	bracket for contact thermostat
4	550020	connecting piece for thermostat and switch

probe clips

clamps

for thermostat



pos.	vare nr.	for pipe ø (mm)	for probe ø (mm)	Qty (pcs)
1	550878	-	6	1
2	550136	-	6	10
3	550877	-	8	1
4	550137	-	8	10



pos.	vare nr.	for pipe ø (mm)	for probe ø (mm)	Qty (pcs)
1	550556	2x8,5	-	1



fig.	vare nr.	for pipe ø (mm)	for probe ø (mm)	L (mm)	Qty (pcs)
1	550930	8.5	6	25	1
1	550135	8.5	6	25	10
2	550043	17x6	6		1

for safety thermostat



pos.	vare nr.	for pipe ø (mm)	for probe ø (mm)	Qty (pcs)
1	550117	8.5	6	1

spring clips

for thermostat



pos.	vare nr.	for pipe ø (mm)	for probe ø (mm)	Qty (pcs)
1	550498	8.5	4	1
2	522106	8.5	4	5
3	550419	8.5	6	1
4	522105	8.5	6	5

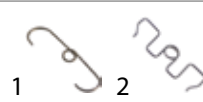

fig.	vare nr.	for pipe ø (mm)	for probe ø (mm)	L (mm)	Qty (pcs)
1	550398	2x8,5	4	42	1
2	551025	2x8,5	6	36	1

for safety thermostat



fig.	vare nr.	for pipe ø (mm)	for probe ø (mm)	Qty (pcs)
1	550539	8.5	4	1
1	551250	8.5	4	5
2	550039	8.5	3.1	1
2	551249	8.5	3.1	5
3	550006	8.5	4	1
3	522104	8.5	4	5
4	550981	8.5	6	1
5	550005	17x6	6	1
5	551248	17x6	6	5
6	550417	2x8,5	6	1
6	522107	2x8,5	6	5



fig.	vare nr.	for pipe ø (mm)	for probe ø (mm)	Qty (pcs)
7	551080	8.5	4	1

capillary tube clips



fig.	vare nr.	description	for pipe ø (mm)	Qty (pcs)
1	551105	capillary tube clip for pipe ø 6mm Qty 1 pcs	6	1
1	551251	capillary tube clip for pipe ø 6mm Qty 5 pcs	6	5
2	550980	capillary tube clip for pipe ø 8,5mm Qty 1 pcs	8.5	1
2	522108	capillary tube clip for pipe ø 8,5 mm	8.5	10



protective pipes for capillary pipes

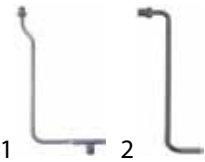

fig.	vare nr.	TS	H1 (mm)	H2 (mm)	L1 (mm)	L2 (mm)
1	551107	M10x1	200	12	190	95
2	550146	M10x1	210	-	25	30

gland nut accessories

ducts



fig.	vare nr.	ET	IT	probe ø max. (mm)	WS
1	550147	3/8"	M13x1	9.5	17
1	550148	M12x0.75	M9x1	6.5	19
1	100820	M14x1.5	M10x0.75	6.5	22
2	550271	M12x0.75	M9x1		
2	550272	M14x1	M9x1		
2	550336	M14x1	M10x1		
3	520216	M14x1	M9x1		

washers with slot



fig.	vare nr.	description
1	510241	washer with slot ED ø 7,8 mm slit width 1,3 mm
1	510591	washer with slot ED ø 8,8mm slit width 1,2mm

gaskets



fig.	vare nr.	description	material	ø (mm)	Qty (pcs)
1	550982	gasket graphite ø 7,5mm L 7mm Qty 1 pcs	graphite	7.5	1
2	510655	gasket silicone ø 7,8mm L 5mm blue Shore 55°	silicone	7.8	10
3	510592	gasket ø 8x8,7mm Qty 10 m slotted silicone	silicone	8x8.7	

bolts with slot



fig.	vare nr.	description
1	520244	bolt with slot M10x1 Qty 10 pcs
1	520243	bolt with slot M9x1 Qty 10 pcs

locking screws



fig.	vare nr.	description
1	504738	screw connection for probe M12x1 ID ø 6,3mm L 18mm
2	106605	union screw M10x1 probe ø max. 4,5mm
3	550926	union screw M12x1 probe ø max. 4mm SS

plunger sockets



fig.	vare nr.	TS	L (mm)	material	ø (mm)
1	550443	1/4"	120	SS	9
2	510987	1/2"	44	SS	10
3	510935	1/2"	100	SS	6.5



fig.	vare nr.	TS	L (mm)	material	ø (mm)
4	506130	1/2"	107	SS	6.5
5	510986	1/2"	120	SS	6.5



fig.	vare nr.	TS	L (mm)	material	ø (mm)
6	550260	1/2"	210	SS/brass	6.5
7	550270	1/2"	90/150	SS/brass	8



fig.	vare nr.	TS	L (mm)	material	ø (mm)
8	550139	3/4"	310	SS	8
9	517292	M10x1	108	SS	10



fig.	vare nr.	TS	L (mm)	material	ø (mm)
10	550538	M10x1	230	SS	4
11	550285	M12x0.75	66	SS	10
12	505207	M12x1.75	95	SS/brass	10



fig.	vare nr.	TS	L (mm)	material	ø (mm)
13	513032	M14x1	34	SS	9
14	511652	M14x1	36	SS	11
15	550995	M14x1	40	SS	9
16	501213	M14x1	147	SS	7



fig.	vare nr.	TS	L (mm)	material	ø (mm)
17	550269	M14x1	235	SS/brass	6.5
18	550149	M14x1.5	224	SS/brass	6.5

connecting bows



fig.	vare nr.	description	Qty (pcs)
1	691005	support bracket for thermostat and switch	
2	550060	connecting bow long for thermostat Qty 1 pcs	1
2	550028	connecting bow long for thermostat Qty 10 pcs	10
3	550059	connecting bow short for switch Qty 1 pcs	1
3	550027	connecting bow short for switch Qty 10 pcs	10

