

heating elements

1

heating elements for ovens.....	17	heating elements for pizza presses.....	106
heating elements for bain maries.....	26	heating elements for rechauds.....	106
heating elements for frying pans.....	36	heating elements for rolling grills.....	107
heating elements for crepes makers.....	37	heating elements for charrills.....	107
heating elements for chip scuttles.....	37	heating elements for salamanders/ toasters.....	109
heating elements for fryers.....	37	heating elements for plate warmers..	118
heating elements for griddles.....	56	heating elements for transport containers.....	118
heating elements for large hobs.....	63	heating elements for heating bridges	118
heating elements for gyros grills.....	64	heating elements for heated cabinets	119
heating elements for chicken rotisseries.....	64	heating elements for heated trolleys..	119
heating elements for hot counters.....	65	heating elements for saladettes.....	120
heating elements for hot dog machines.....	67	dry heating elements for dishwashers.....	120
heating elements for coffee machine..	67	bottom heaters.....	121
heating elements for refrigeration.....	82	heaters.....	121
heating elements for tilting bratt pan..	86	heating cables.....	122
heating elements for contact grills.....	91	heating cartridges.....	123
heating elements for microwaves.....	95	heating plates.....	124
heating elements for pasta cookers.....	95	heater battery.....	125
heating elements for pizza ovens.....	99		

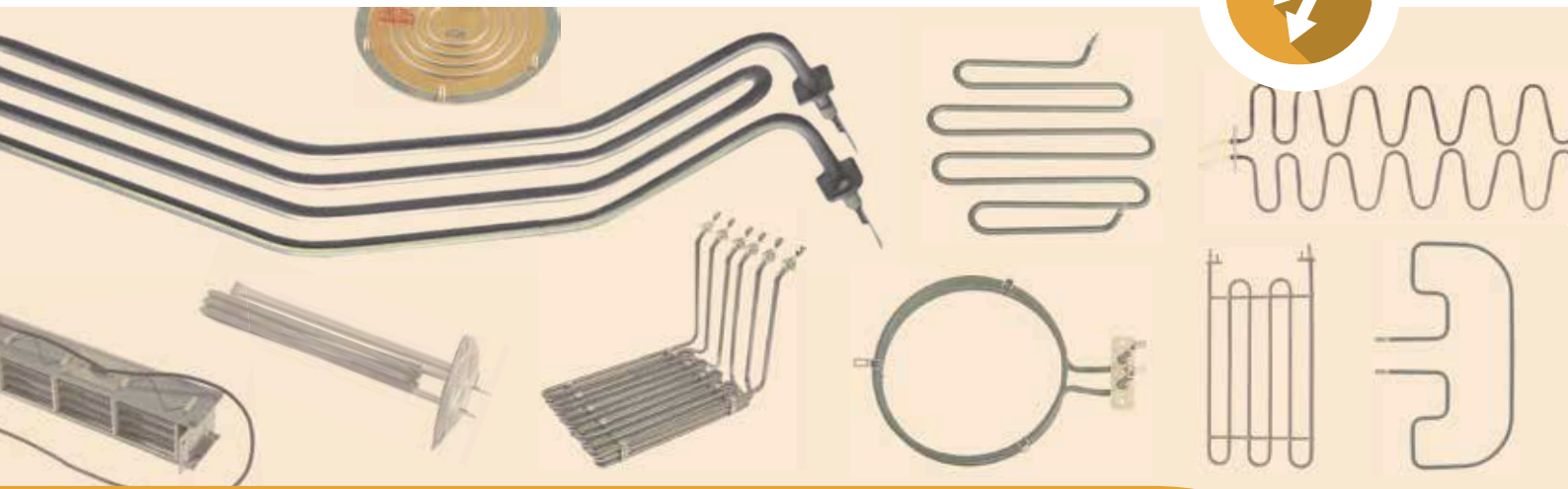

heating elements

1

heating rods.....	125
induction coils.....	126
ceramic heaters.....	126
contact heaters.....	127
pilot heating elements.....	127
quartz heating elements.....	128
grooved tubular heating elements.....	130
coil heating elements.....	131
immersion heating elements.....	132
heating elements for convection.....	166
radiation heaters.....	186
flow heaters.....	187
foil heating elements.....	188
accessories.....	190



heating elements

heating elements for ovens

Ambach

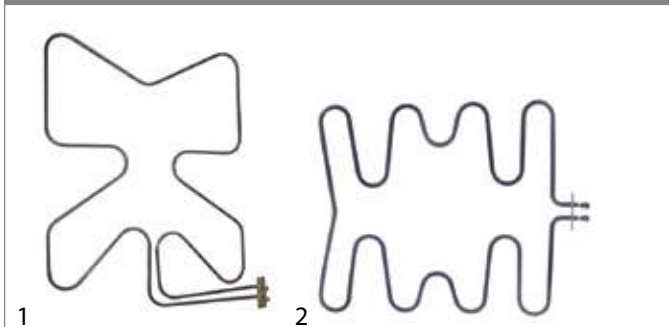

fig.	Vare nr.	P (W)	volt. (V)	HC	L (mm)	W (mm)	Ref. No.
1	415864	2000	400	1	570	445	5060804349
2	416950	3000	400	1	453	403	5060815275

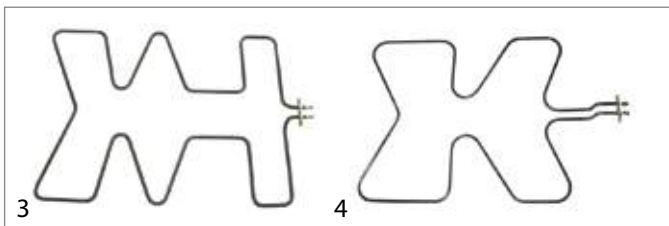

fig.	Vare nr.	P (W)	volt. (V)	HC	L (mm)	W (mm)	Ref. No.
3	415861	3000	400	1	607	447	5060825601
4	415865	3000	400	1	670	445	5060804348

Ambassade

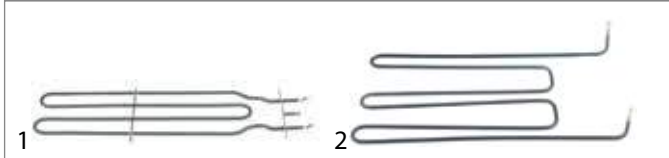

fig.	Vare nr.	P (W)	volt. (V)	HC	L (mm)	W (mm)	Ref. No.
1	418479	950	230	1	405	96	6530624
2	418478	1000	230	1	420	200	65211007

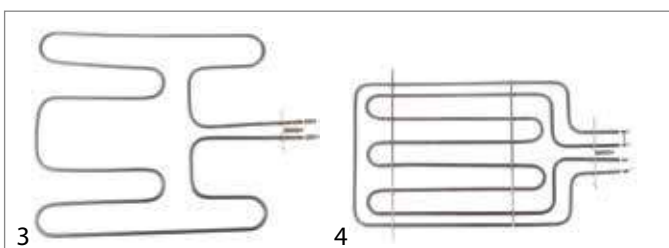

fig.	Vare nr.	P (W)	volt. (V)	HC	L (mm)	W (mm)	Ref. No.
3	418546	1800	230	1	405	324	6536147
4	418545	3100	230	2	415	258	6530051

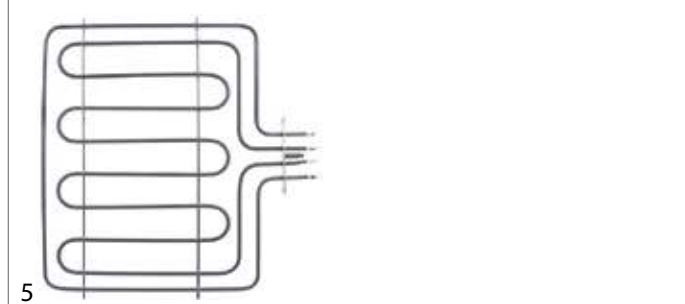

fig.	Vare nr.	P (W)	volt. (V)	HC	L (mm)	W (mm)	Ref. No.
5	418961	4050	230	2	400	467	6535970

Angelo-Po

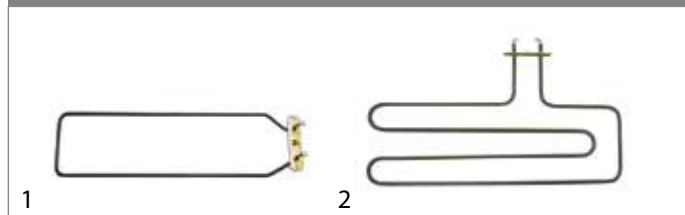

fig.	Vare nr.	P (W)	volt. (V)	HC	L (mm)	W (mm)	Ref. No.
1	415171	900	230	1	430	122	32G0080
2	415673	2600	415	1	251	510	32G1621
2	415169	2700	380	1	450	590	32G0951

Anitec



fig.	Vare nr.	P (W)	volt. (V)	HC	L (mm)	W (mm)	Ref. No.
1	416043	990	230	1	475	106	X47000

Ascobloc

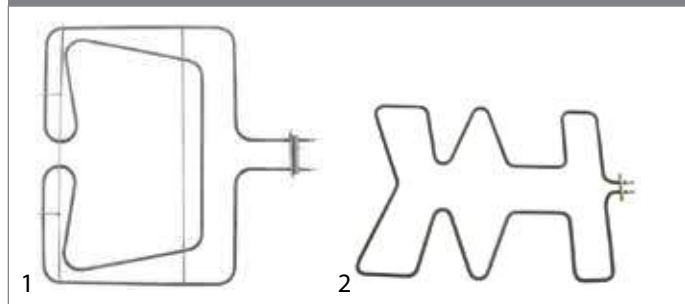

fig.	Vare nr.	P (W)	volt. (V)	HC	L (mm)	W (mm)	Ref. No.
1	415995	1500	400	1	460	484	9294281
2	415861	3000	400	1	607	447	09/3347

Baron

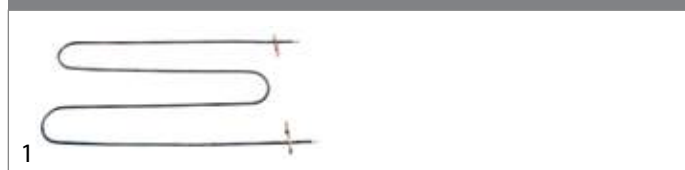

fig.	Vare nr.	P (W)	volt. (V)	HC	L (mm)	W (mm)	Ref. No.
1	418025	1500	230	1	525	240	BN826620041

1 heating elements



Bartscher

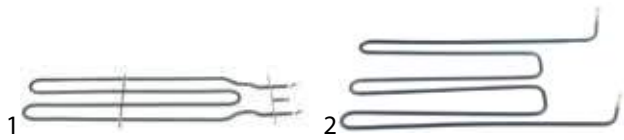

fig.	Vare nr.	P (W)	volt. (V)	HC	L (mm)	W (mm)	Ref. No.
1	418479	950	230	1	405	96	06530624
2	418478	1000	230	1	420	200	065211007

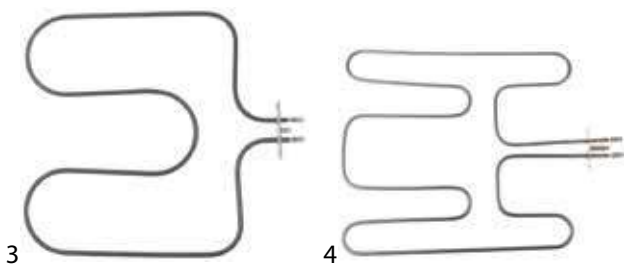

fig.	Vare nr.	P (W)	volt. (V)	HC	L (mm)	W (mm)	Ref. No.
3	420276	1500	230	1	313	300	ORES009
4	418546	1800	230	1	405	324	021061

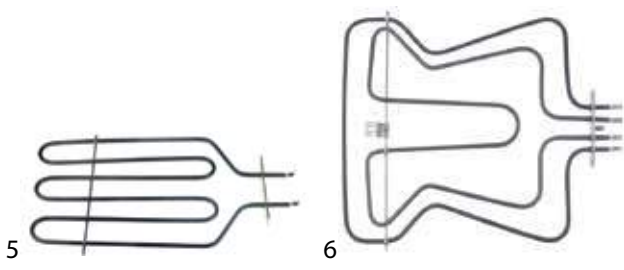

fig.	Vare nr.	P (W)	volt. (V)	HC	L (mm)	W (mm)	Ref. No.
5	416855	2300	230	1	345	213	030008373
6	420275	2400	230	2	335	300	ORES039

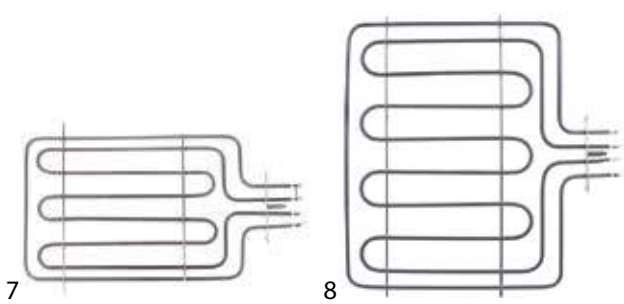

fig.	Vare nr.	P (W)	volt. (V)	HC	L (mm)	W (mm)	Ref. No.
7	418545	3100	230	2	415	258	021060
8	418961	4050	230	2	400	467	023319

Bertos

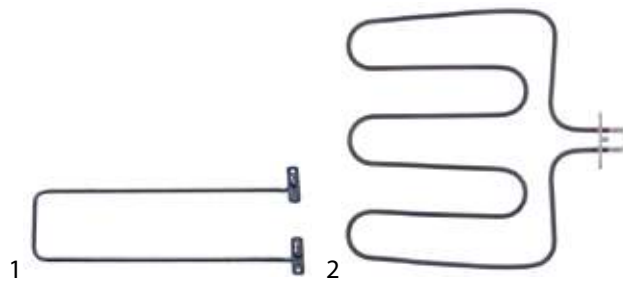

fig.	Vare nr.	P (W)	volt. (V)	HC	L (mm)	W (mm)	Ref. No.
1	415294	900	230	1	468	112	31320000
2	416042	1500	230	1	365	500	22016700

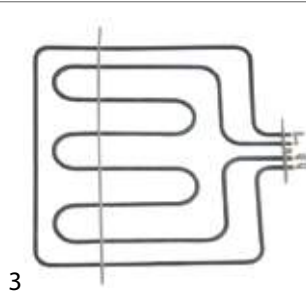

fig.	Vare nr.	P (W)	volt. (V)	HC	L (mm)	W (mm)	Ref. No.
3	416041	2600	230	2	350	355	22016900

Bonnet

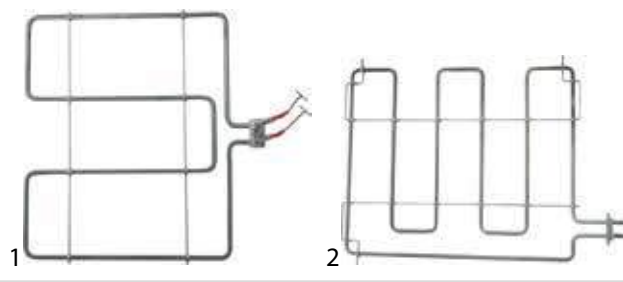

fig.	Vare nr.	P (W)	volt. (V)	HC	L (mm)	W (mm)	Ref. No.
1	418524	1800	400	1	416	438	302189
2	418525	3300	400	1	610	450	302191

Capic

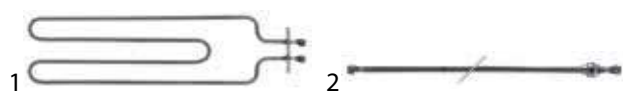

fig.	Vare nr.	P (W)	volt. (V)	HC	L (mm)	W (mm)	Ref. No.
1	418943	500	230	1	400	110	E150515
2	418945	500	230	1	695	-	E150514

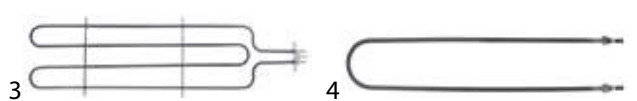



fig.	Vare nr.	P (W)	volt. (V)	HC	L (mm)	W (mm)	Ref. No.
3	418941	850	220	1	650	148	E150564
3	418942	850	230	1	645	145	E150556
4	418947	1000	230	1	400	90	E150596
4	418949	1500	230	1	580	110	E150846
4	418948	1500	230	1	730	110	E150852



fig.	Vare nr.	P (W)	volt. (V)	HC	L (mm)	W (mm)	Ref. No.
5	418944	1000	230	1	550	110	E150572
6	418847	1500	230	1	450	60	E150855

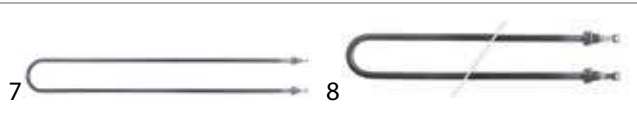

fig.	Vare nr.	P (W)	volt. (V)	HC	L (mm)	W (mm)	Ref. No.
7	418950	2000	230	1	900	115	E150860
7	418951	2250	230	1	700	90	E151107
8	418952	2000	230	1	1300	65	E150866
8	418953	3000	230	1	1295	60	E151170



fig.	Vare nr.	P (W)	volt. (V)	HC	L (mm)	W (mm)	Ref. No.
9	418954	4000	230	1	850	105	E151465

Charvet

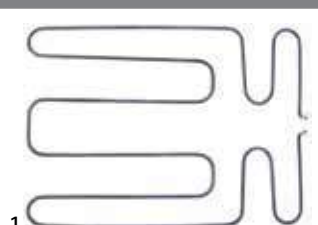

fig.	Vare nr.	P (W)	volt. (V)	HC	L (mm)	W (mm)	Ref. No.
1	420237	2500	230	1	600	435	02062A
1	420236	2500	400	1	600	435	02063A

Cookmax

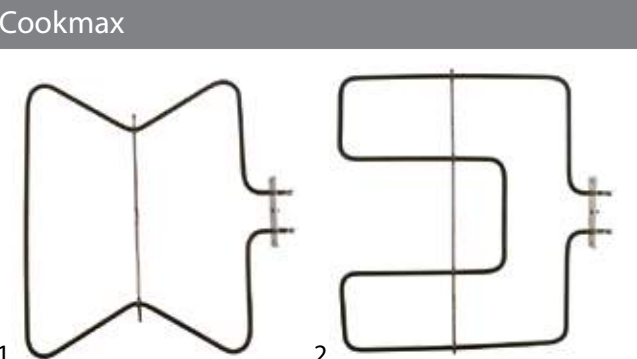

fig.	Vare nr.	P (W)	volt. (V)	HC	L (mm)	W (mm)	Ref. No.
1	418695	900	230	1	350	390	CR0410140
2	418696	1300	230	1	350	380	CR0410150

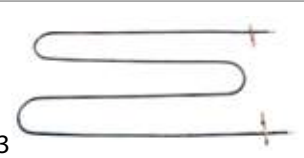

fig.	Vare nr.	P (W)	volt. (V)	HC	L (mm)	W (mm)	Ref. No.
3	418025	1500	230	1	525	240	41826620041

EGO

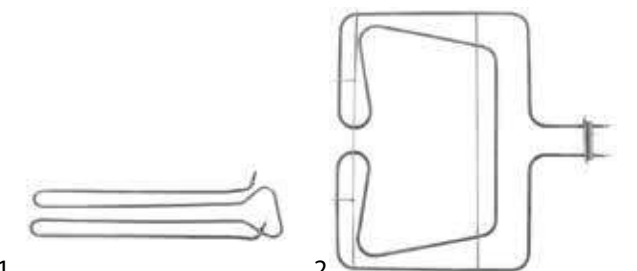

fig.	Vare nr.	P (W)	volt. (V)	HC	L (mm)	W (mm)	Ref. No.
1	415078	1500	240	1	540	150	24.10007.210
2	415995	1500	400	1	460	484	20.21708.050

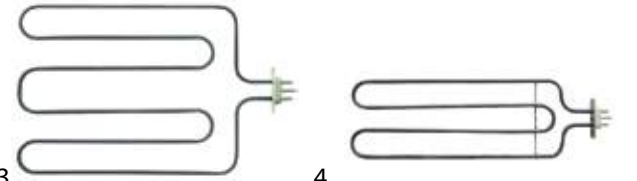
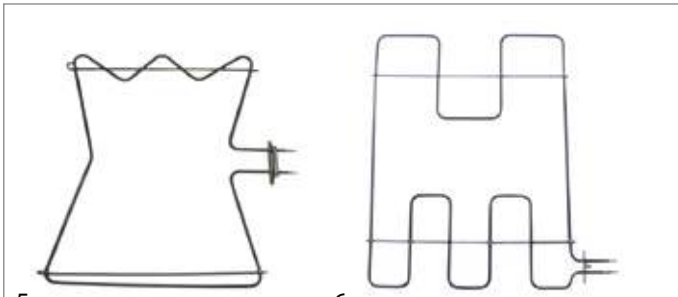

fig.	Vare nr.	P (W)	volt. (V)	HC	L (mm)	W (mm)	Ref. No.
3	415315	2000	230	1	327	228	24.13001.060 24.13001.851
3	415317	2500	230	1	360	242	24.13012.020
4	415318	2000	230	1	427	138	24.13230.040
4	415316	2500	230	1	543	140	24.13004.010
4	415319	3000	230	1	643	145	24.13241.000



5

6

fig.	Vare nr.	P (W)	volt. (V)	HC	L (mm)	W (mm)	Ref. No.
5	415795	2000	400	1	490	575	20.21750.030
6	415223	2500	400	1	450	570	20.24354.101

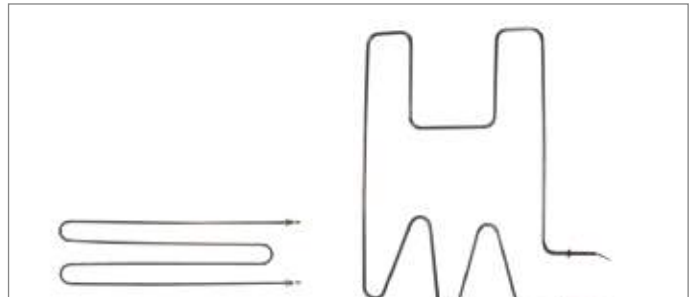

5

6

fig.	Vare nr.	P (W)	volt. (V)	HC	L (mm)	W (mm)	Ref. No.
5	415350	1600	400	1	610	180	0K4982
6	415356	2750	400	1	538	618	0K4863

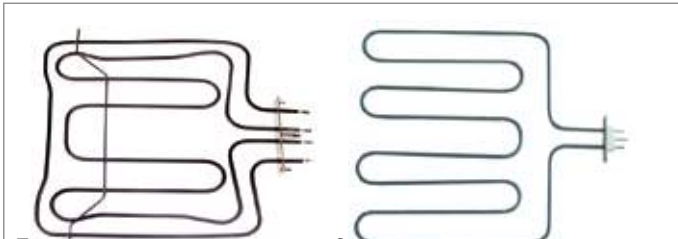

7

8

fig.	Vare nr.	P (W)	volt. (V)	HC	L (mm)	W (mm)	Ref. No.
7	418511	2700	230	2	370	390	20.40888.000
8	415320	3000	230	1	350	313	24.13243.020

Emmepi

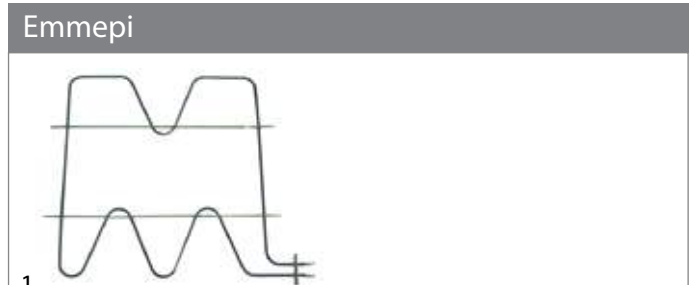

1

fig.	Vare nr.	P (W)	volt. (V)	HC	L (mm)	W (mm)	Ref. No.
1	416068	2500	230	1	525	500	C00215

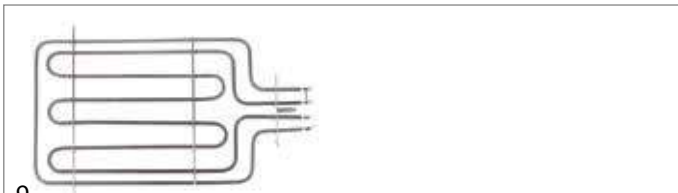

9

fig.	Vare nr.	P (W)	volt. (V)	HC	L (mm)	W (mm)	Ref. No.
9	418545	3100	230	2	415	258	12434034024 24.34034.023

Fagor



1

2

fig.	Vare nr.	P (W)	volt. (V)	HC	L (mm)	W (mm)	Ref. No.
1	416018	1000	230	1	515	125	12024610
2	416608	1000	230	1	515	170	12018965

Electrolux

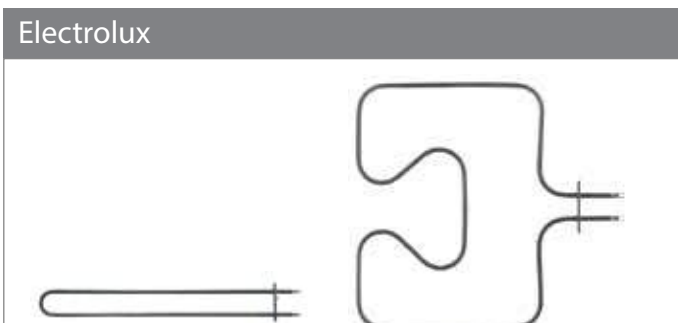

1

2

fig.	Vare nr.	P (W)	volt. (V)	HC	L (mm)	W (mm)	Ref. No.
1	415378	950	230	1	550	63	059237
2	418078	1000	230	1	335	345	005218

Falcon

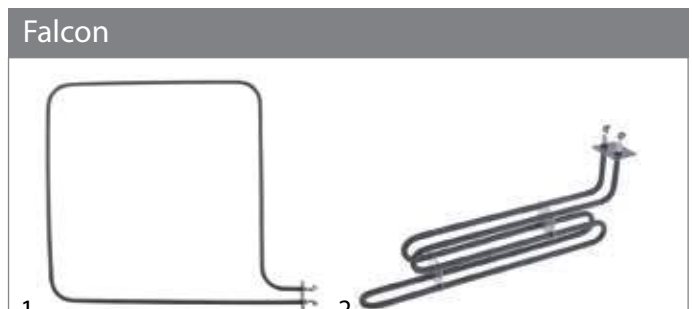

1

2

fig.	Vare nr.	P (W)	volt. (V)	HC	L (mm)	W (mm)	Ref. No.
1	418873	650	240	1	505	440	539110450
2	418872	1250	240	1	370	130	539110460



3

4

fig.	Vare nr.	P (W)	volt. (V)	HC	L (mm)	W (mm)	Ref. No.
3	415078	1500	240	1	540	150	054147
4	417442	1500	400	1	535	140	0C2813



Garbin

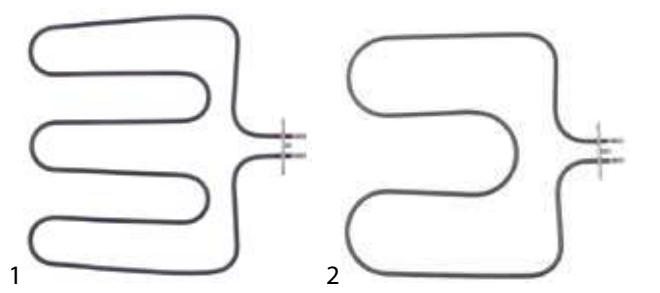

fig.	Vare nr.	P (W)	volt. (V)	HC	L (mm)	W (mm)	Ref. No.
1	418792	1400	230	1	315	320	RES155
2	420276	1500	230	1	313	300	RES009

GIGA

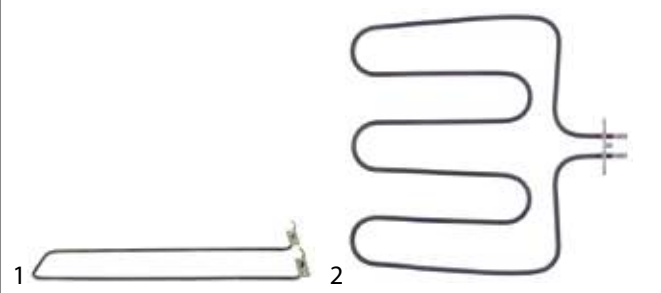

fig.	Vare nr.	P (W)	volt. (V)	HC	L (mm)	W (mm)	Ref. No.
1	416043	990	230	1	475	106	X47000
2	416042	1500	230	1	365	500	X68203

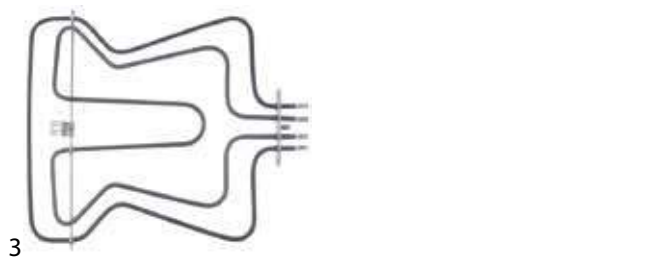

fig.	Vare nr.	P (W)	volt. (V)	HC	L (mm)	W (mm)	Ref. No.
3	420275	2400	230	2	335	300	RES008

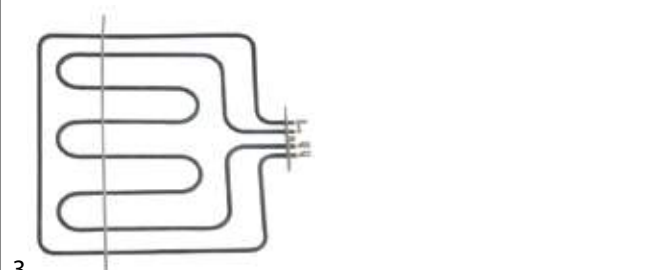

fig.	Vare nr.	P (W)	volt. (V)	HC	L (mm)	W (mm)	Ref. No.
3	416041	2600	230	2	350	355	X68202

Gico

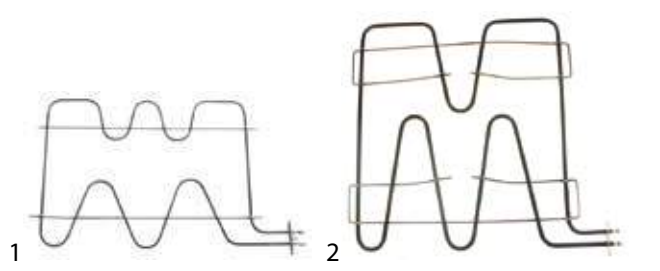

fig.	Vare nr.	P (W)	volt. (V)	HC	L (mm)	W (mm)	Ref. No.
1	416090	2000	230	1	500	325	260200070
2	416091	2740	230	1	500	485	270200402
2	416092	2740	400	1	500	485	270203360

Heidebrenner

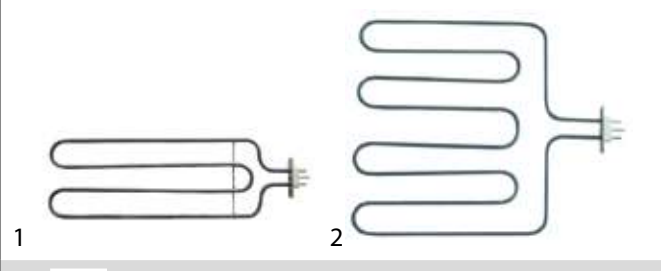

fig.	Vare nr.	P (W)	volt. (V)	HC	L (mm)	W (mm)	Ref. No.
1	415318	2000	230	1	427	138	92732
2	415320	3000	230	1	350	313	92734

Gierre

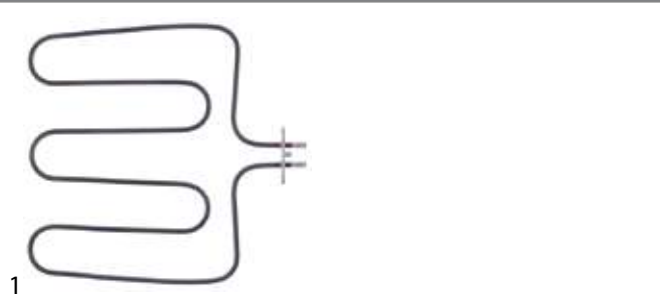

fig.	Vare nr.	P (W)	volt. (V)	HC	L (mm)	W (mm)	Ref. No.
1	418792	1400	230	1	315	320	RES155

Indesit

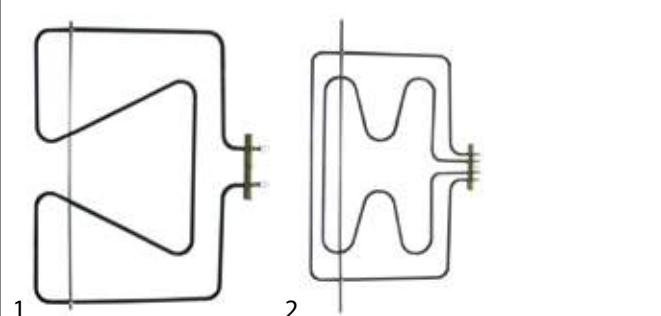

fig.	Vare nr.	P (W)	volt. (V)	HC	L (mm)	W (mm)	Ref. No.
1	415775	1750	230	1	326	405	C00144237
2	415774	3050	230	2	325	474	C00141175



Kreffft

fig.	Vare nr.	P (W)	volt. (V)	HC	L (mm)	W (mm)	Ref. No.
1	415995	1500	400	1	460	484	49-182322
1	417605	2100	400	1	465	480	49-160631
2	415795	2000	400	1	490	575	49-182325

Lotus

fig.	Vare nr.	P (W)	volt. (V)	HC	L (mm)	W (mm)	Ref. No.
1	418067	800	230	1	685	125	537027800
1	416516	1200	230	1	505	123	537020901
2	415776	1500	220	1	285	205	537006400

KSF

fig.	Vare nr.	P (W)	volt. (V)	HC	L (mm)	W (mm)	Ref. No.
1	415315	2000	230	1	327	228	4.013.03.06

fig.	Vare nr.	P (W)	volt. (V)	HC	L (mm)	W (mm)	Ref. No.
3	415775	1750	230	1	326	405	537006300
4	415774	3050	230	2	325	474	537006200

Küppersbusch

fig.	Vare nr.	P (W)	volt. (V)	HC	L (mm)	W (mm)	Ref. No.
1	415995	1500	400	1	460	484	182322
1	417605	2100	400	1	465	480	160631
2	415795	2000	400	1	490	575	182325

Malag

fig.	Vare nr.	P (W)	volt. (V)	HC	L (mm)	W (mm)	Ref. No.
1	415315	2000	230	1	327	228	105597

Lohberger

fig.	Vare nr.	P (W)	volt. (V)	HC	L (mm)	W (mm)	Ref. No.
1	415223	2500	400	1	450	570	51440360

Mareno

fig.	Vare nr.	P (W)	volt. (V)	HC	L (mm)	W (mm)	Ref. No.
1	415972	750	230	1	483	64	MA1890600
2	418695	900	230	1	350	390	CR0410140



fig.	Vare nr.	P (W)	volt. (V)	HC	L (mm)	W (mm)	Ref. No.
3	416808	1000	230	1	555	63	MACM018102
4	415968	1200	230	1	346	342	MA1037302400

fig.	Vare nr.	P (W)	volt. (V)	HC	L (mm)	W (mm)	Ref. No.
3	416543	3200	230	1	510	526	RTCU700281
4	418491	3750	230	1	505	642	161661

fig.	Vare nr.	P (W)	volt. (V)	HC	L (mm)	W (mm)	Ref. No.
5	418696	1300	230	1	350	380	CR0410150
6	420111	1500	230	1	555	210	CR0681390

MIWE

fig.	Vare nr.	P (W)	volt. (V)	HC	L (mm)	W (mm)	Ref. No.
1	420349	4000	400	1	573	115	040504.01

fig.	Vare nr.	P (W)	volt. (V)	HC	L (mm)	W (mm)	Ref. No.
7	415967	2600	230/400	2	355	360	MA1037302300

MKN

fig.	Vare nr.	P (W)	volt. (V)	HC	L (mm)	W (mm)	Ref. No.
1	415781	900	380	1	497	313	574064
1	415783	1200	380	1	510	295	574066
2	416448	1275	230	1	325	202	574089

MBM-Italia

fig.	Vare nr.	P (W)	volt. (V)	HC	L (mm)	W (mm)	Ref. No.
1	418495	1800	230	1	320	287	RIC0001836
2	418148	2500	230	1	530	615	RTCU900186

fig.	Vare nr.	P (W)	volt. (V)	HC	L (mm)	W (mm)	Ref. No.
3	415787	1450	400	1	502	455	574081
3	415785	1500	380	1	505	463	574083
3	415812	1700	400	1	495	635	574070
4	415570	1500	230	1	470	200	574087

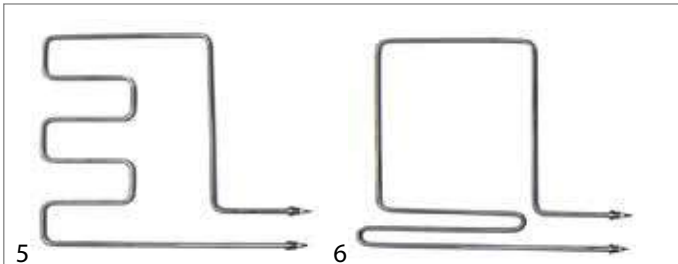



fig.	Vare nr.	P (W)	volt. (V)	HC	L (mm)	W (mm)	Ref. No.
5	415786	1500	380	1	432	392	574082
6	415788	1700	380	1	475	386	574080
6	415813	1950	400	1	467	520	574071

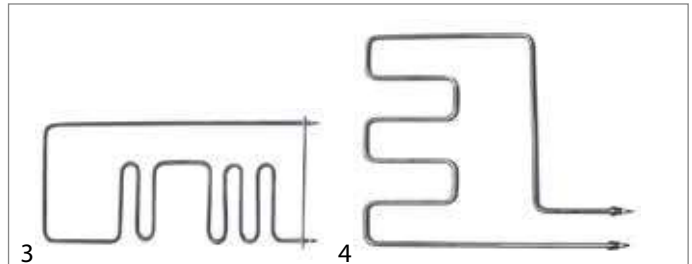

fig.	Vare nr.	P (W)	volt. (V)	HC	L (mm)	W (mm)	Ref. No.
3	415570	1500	230	1	470	200	731811
4	415786	1500	380	1	432	392	290696

Modular

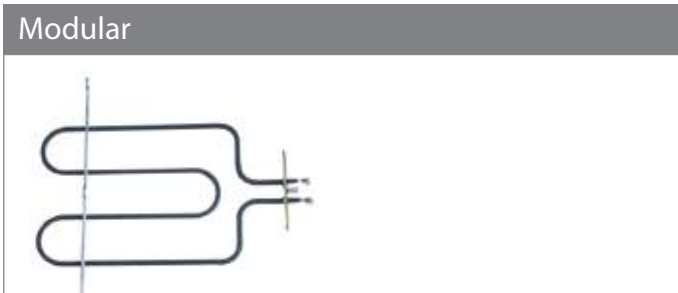

fig.	Vare nr.	P (W)	volt. (V)	HC	L (mm)	W (mm)	Ref. No.
1	416533	1400	230	1	305	180	66506200

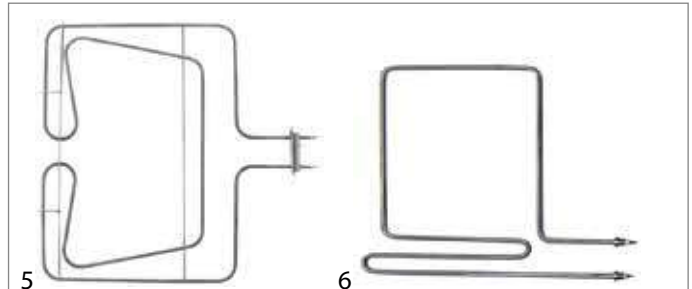

fig.	Vare nr.	P (W)	volt. (V)	HC	L (mm)	W (mm)	Ref. No.
5	415995	1500	400	1	460	484	150673
6	415788	1700	380	1	475	386	290726
6	415813	1950	400	1	467	520	290785

Olis



fig.	Vare nr.	P (W)	volt. (V)	HC	L (mm)	W (mm)	Ref. No.
1	418025	1500	230	1	525	240	BN826620041

Rosinox



fig.	Vare nr.	P (W)	volt. (V)	HC	L (mm)	W (mm)	Ref. No.
1	415341	735	230	1	387	108	RX94805777
1	415294	900	230	1	468	112	RX94806460

Palux

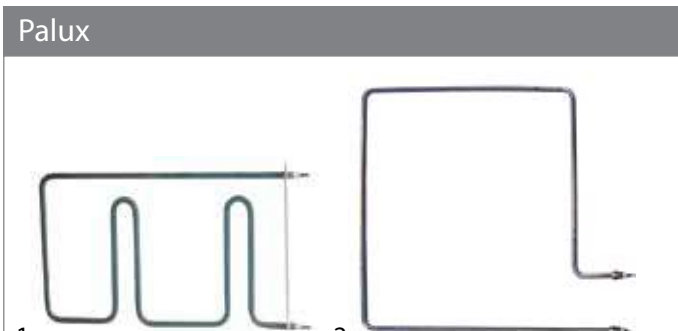

fig.	Vare nr.	P (W)	volt. (V)	HC	L (mm)	W (mm)	Ref. No.
1	416448	1275	230	1	325	202	637742
2	415787	1450	400	1	502	455	290718
2	415785	1500	380	1	505	463	290688
2	415812	1700	400	1	495	635	290777

RSI



fig.	Vare nr.	P (W)	volt. (V)	HC	L (mm)	W (mm)	Ref. No.
1	416855	2300	230	1	345	213	30008373

Silko

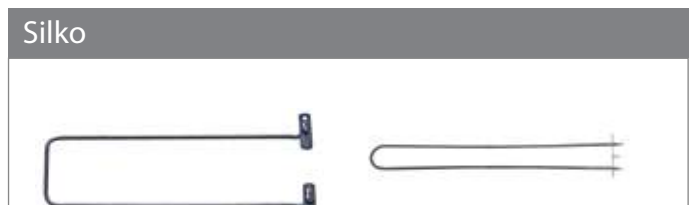

fig.	Vare nr.	P (W)	volt. (V)	HC	L (mm)	W (mm)	Ref. No.
1	415341	735	230	1	387	108	SIR0101556
1	415294	900	230	1	468	112	SIR0101554
2	415395	800	240	1	540	60	SIR0101553

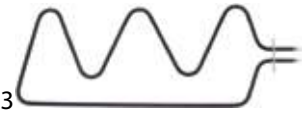



fig.	Vare nr.	P (W)	volt. (V)	HC	L (mm)	W (mm)	Ref. No.
3	420111	1500	230	1	555	210	CR0681390

Smeg

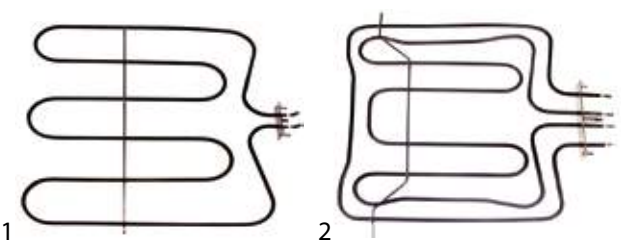

fig.	Vare nr.	P (W)	volt. (V)	HC	L (mm)	W (mm)	Ref. No.
1	418512	1190	220	1	375	400	806890366
2	418511	2700	230	2	370	390	806890527

Star10

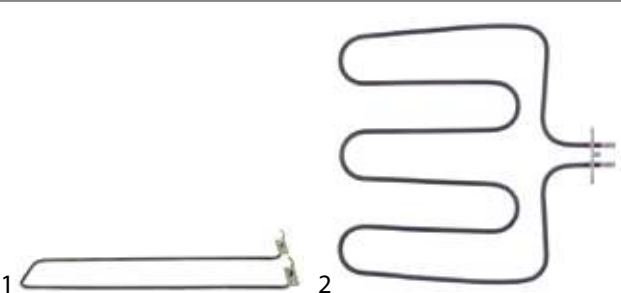

fig.	Vare nr.	P (W)	volt. (V)	HC	L (mm)	W (mm)	Ref. No.
1	416043	990	230	1	475	106	X47000
2	416042	1500	230	1	365	500	X68203

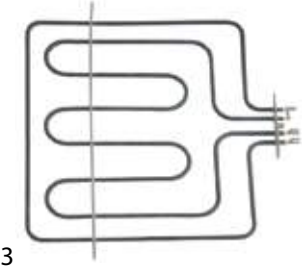

fig.	Vare nr.	P (W)	volt. (V)	HC	L (mm)	W (mm)	Ref. No.
3	416041	2600	230	2	350	355	X68202

Star-Manufacturing

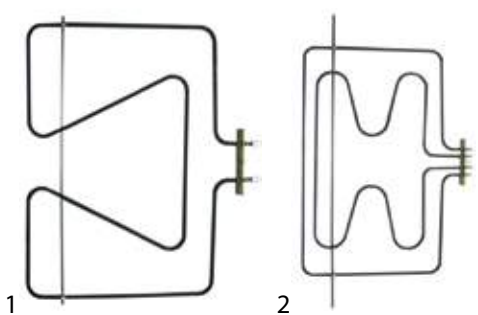

fig.	Vare nr.	P (W)	volt. (V)	HC	L (mm)	W (mm)	Ref. No.
1	415775	1750	230	1	326	405	10013150430
2	415774	3050	230	2	325	474	16002032700

Tecnoeka

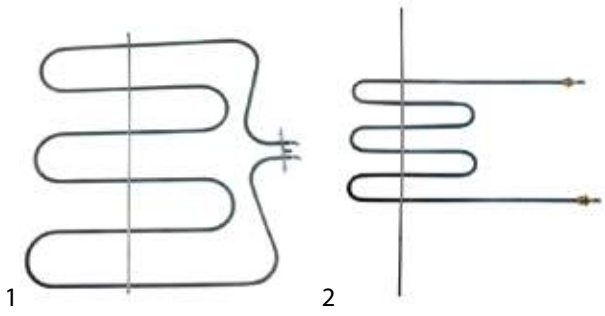

fig.	Vare nr.	P (W)	volt. (V)	HC	L (mm)	W (mm)	Ref. No.
1	416969	1400	230	1	370	400	01200870
2	416968	2000	230	1	347	215	09950027000

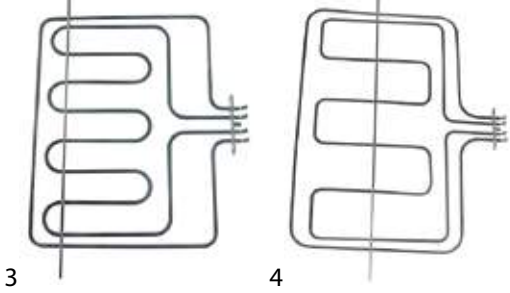

fig.	Vare nr.	P (W)	volt. (V)	HC	L (mm)	W (mm)	Ref. No.
3	416970	2800	230	2	323	393	09950317000
4	416972	3700	230	2	442	575	01200910

Tecnoinox



fig.	Vare nr.	P (W)	volt. (V)	HC	L (mm)	W (mm)	Ref. No.
1	416601	1000	230	1	396	65	RC00775000

Therma

fig.	Vare nr.	P (W)	volt. (V)	HC	L (mm)	W (mm)	Ref. No.
1	415350	1600	400	1	610	180	0K4982
2	415356	2750	400	1	538	618	0K4863

Unox

fig.	Vare nr.	P (W)	volt. (V)	HC	L (mm)	W (mm)	Ref. No.
1	417565	122	105	1	85	31	KRS1261A
2	417566	122	105	1	85	31	RS1261A0

fig.	Vare nr.	P (W)	volt. (V)	HC	L (mm)	W (mm)	Ref. No.
3	417548	147	105	1	88	30.5	KRS1215A
4	417549	147	105	1	88	30.5	RS1215A0

Zanussi

fig.	Vare nr.	P (W)	volt. (V)	HC	L (mm)	W (mm)	Ref. No.
1	415378	950	230	1	550	63	059237
2	418078	1000	230	1	335	345	005218

fig.	Vare nr.	P (W)	volt. (V)	HC	L (mm)	W (mm)	Ref. No.
3	415078	1500	240	1	540	150	054147

heating elements for bain maries

fig.	Vare nr.	P (W)	volt. (V)	L (mm)	W (mm)	Ref. No.
1	418318	700	230	370	155	M113044

Alpeninox

fig.	Vare nr.	P (W)	volt. (V)	L (mm)	W (mm)	Ref. No.
1	415096	550	230	438	44	0A2197
1	415097	800	230	630	44	0A2137

Ambach

fig.	Vare nr.	P (W)	volt. (V)	L (mm)	W (mm)	Ref. No.
1	415852	800	230	545	40	5060808748
2	415688	2000	230	410	150	5060801490
2	416957	2000	230	410	150	5060811860

fig.	Vare nr.	P (W)	volt. (V)	L (mm)	W (mm)	Ref. No.
3	415851	2000	230	483	138	5060802391
3	415612	2000	400	482	138	5060802200

Ambassade

fig.	Vare nr.	P (W)	volt. (V)	L (mm)	W (mm)	Ref. No.
1	418478	1000	230	420	200	65211007



Angelo-Po

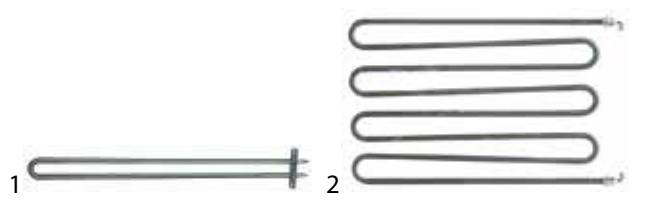

fig.	Vare nr.	P (W)	volt. (V)	L (mm)	W (mm)	Ref. No.
1	416683	1000	230	480	35	32G2220
2	416682	1450	230	378	252	32G0280

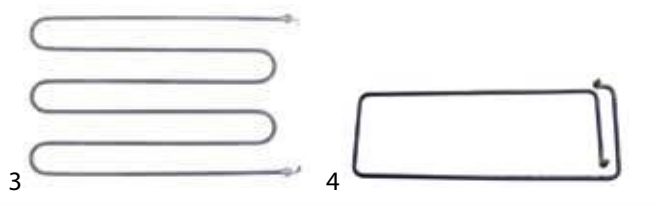

fig.	Vare nr.	P (W)	volt. (V)	L (mm)	W (mm)	Ref. No.
3	418688	1500	230	470	305	32G1730
4	415173	1600	230	585	200	32G0071

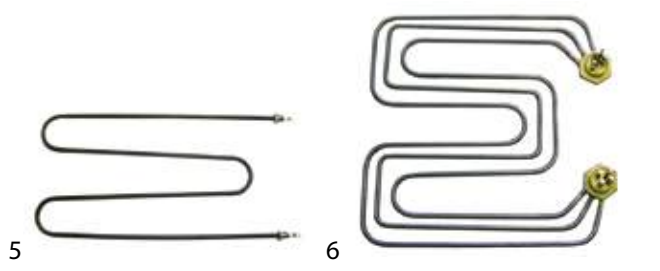

fig.	Vare nr.	P (W)	volt. (V)	L (mm)	W (mm)	Ref. No.
5	415181	2000	230	458	208	32G1250
6	415175	4800	220	410	417	32G0650

Anitec

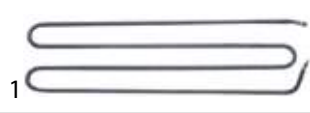

fig.	Vare nr.	P (W)	volt. (V)	L (mm)	W (mm)	Ref. No.
1	416161	1000	230	430	95	071027

Aristarco



fig.	Vare nr.	P (W)	volt. (V)	L (mm)	W (mm)	Ref. No.
1	416244	1000	230	258	34	00000386

Ascobloc

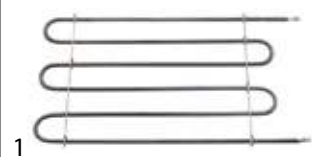

fig.	Vare nr.	P (W)	volt. (V)	L (mm)	W (mm)	Ref. No.
1	416912	750	230	375	200	09 1343

Baron

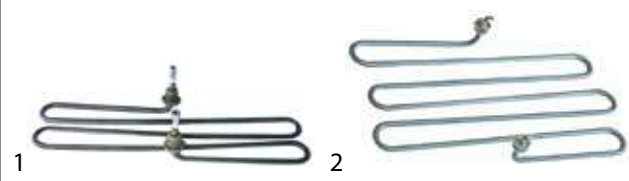

fig.	Vare nr.	P (W)	volt. (V)	L (mm)	W (mm)	Ref. No.
1	415091	1000	230	295	85	MA1037039513
2	416796	1500	240	325	180	BN6A045700



fig.	Vare nr.	P (W)	volt. (V)	L (mm)	W (mm)	Ref. No.
3	418036	2200	230	458	186	41826620101

Bartscher

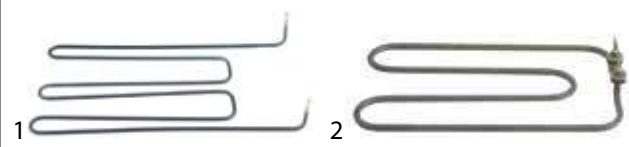

fig.	Vare nr.	P (W)	volt. (V)	L (mm)	W (mm)	Ref. No.
1	418478	1000	230	420	200	065211007
2	416067	1380	230	346	190	06001024



fig.	Vare nr.	P (W)	volt. (V)	L (mm)	W (mm)	Ref. No.
3	416796	1500	240	325	180	018160



Bertos

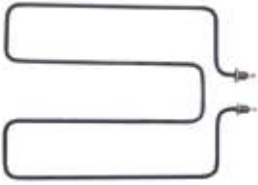

fig.	Vare nr.	P (W)	volt. (V)	L (mm)	W (mm)	Ref. No.
1	415844	2600	230	410	300	22015800

Blanco

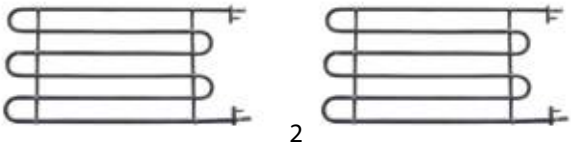

fig.	Vare nr.	P (W)	volt. (V)	L (mm)	W (mm)	Ref. No.
1	415544	700	230	392	198	105020
1	415587	1000	230	390	197	105030
2	415596	1500	230	395	198	105439

Blumauer



fig.	Vare nr.	P (W)	volt. (V)	L (mm)	W (mm)	Ref. No.
1	415583	1100	380	435	202	180355

Bonnet



fig.	Vare nr.	P (W)	volt. (V)	L (mm)	W (mm)	Ref. No.
1	418913	1800	230	507	70	311739

Capic

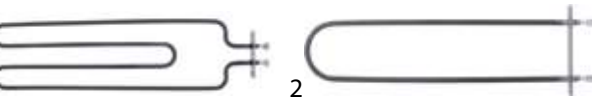

fig.	Vare nr.	P (W)	volt. (V)	L (mm)	W (mm)	Ref. No.
1	418844	700	230	395	105	E150540
2	420163	750	230	482	110	E150544
2	420164	1000	230	483	110	E150570



fig.	Vare nr.	P (W)	volt. (V)	L (mm)	W (mm)	Ref. No.
3	420165	1600	230	395	110	E150806

Capito



fig.	Vare nr.	P (W)	volt. (V)	L (mm)	W (mm)	Ref. No.
1	418250	1500	230	265	244	63857

CF-Cenedese

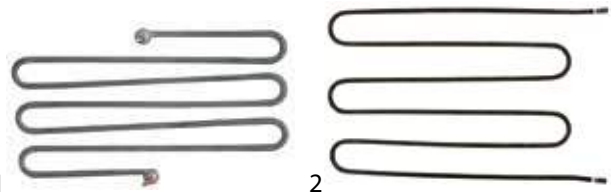

fig.	Vare nr.	P (W)	volt. (V)	L (mm)	W (mm)	Ref. No.
1	416194	1189	230	278	150	63.7.1052
2	416195	1500	230	368	268	63.7.1023

Charvet



fig.	Vare nr.	P (W)	volt. (V)	L (mm)	W (mm)	Ref. No.
1	420002	2000	230	383	235	03746A

Cidelcem-Iseco



fig.	Vare nr.	P (W)	volt. (V)	L (mm)	W (mm)	Ref. No.
1	415695	1500	230	268	-	—



Cookmax

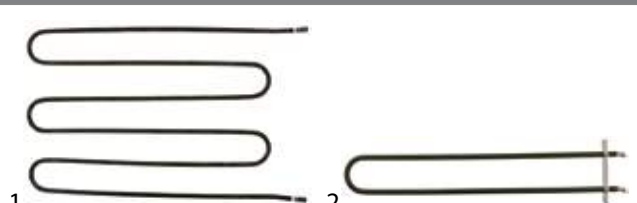

fig.	Vare nr.	P (W)	volt. (V)	L (mm)	W (mm)	Ref. No.
1	418668	700	230	370	230	40121700
1	416195	1500	230	368	268	401023000
2	418694	750	230	410	63	CR0502320



fig.	Vare nr.	P (W)	volt. (V)	L (mm)	W (mm)	Ref. No.
3	415091	1000	230	295	85	1037039513
4	418036	2200	230	458	186	41826620101

Dexion

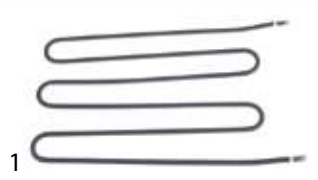

fig.	Vare nr.	P (W)	volt. (V)	L (mm)	W (mm)	Ref. No.
1	418344	1200	220	395	220	3710003

EGO

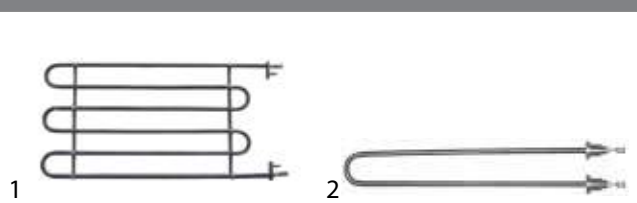

fig.	Vare nr.	P (W)	volt. (V)	L (mm)	W (mm)	Ref. No.
1	415544	700	230	392	198	20.23487.040
1	415587	1000	230	390	197	20.23487.010
2	415055	1000	230	248	36	24.22154.000

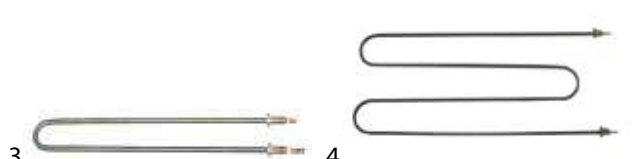

fig.	Vare nr.	P (W)	volt. (V)	L (mm)	W (mm)	Ref. No.
3	415050	1000	230	260	38	24.22164.020
4	415635	1000	230	455	210	20.21074.030

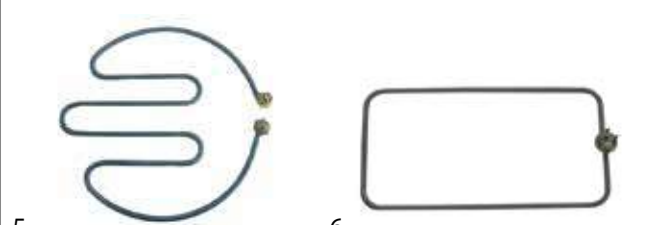

fig.	Vare nr.	P (W)	volt. (V)	L (mm)	W (mm)	Ref. No.
5	415750	1500	230	245	235	20.12804.000
6	415565	1500	230	350	180	20.12508.000

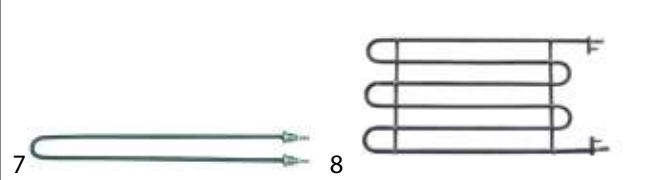

fig.	Vare nr.	P (W)	volt. (V)	L (mm)	W (mm)	Ref. No.
7	415056	1500	230	379	35	24.22155.000
7	415051	1500	230	390	36	24.22165.020 24.22251.010
8	415596	1500	230	395	198	20.23487.000

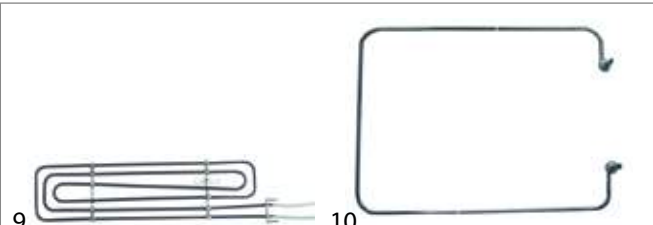

fig.	Vare nr.	P (W)	volt. (V)	L (mm)	W (mm)	Ref. No.
9	415323	1600	230	383	96	24.33117.000
10	415669	2000	230	452	256	20.23661.000



fig.	Vare nr.	P (W)	volt. (V)	L (mm)	W (mm)	Ref. No.
11	415052	2000	230	485	40	24.22166.000
11	415057	2000	230	490	35	24.22156.000
11	415053	2500	220	620	39	24.22167.000
11	415054	3000	230	730	37	24.22168.010

EKU

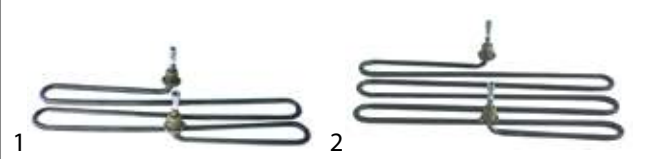

fig.	Vare nr.	P (W)	volt. (V)	L (mm)	W (mm)	Ref. No.
1	415091	1000	230	295	85	1W217
2	415092	1300	230	290	130	4-06



Electrolux

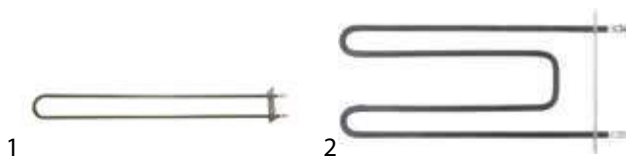

fig.	Vare nr.	P (W)	volt. (V)	L (mm)	W (mm)	Ref. No.
1	415096	550	230	438	44	0A2197
1	415097	800	230	630	44	0A2137
2	419099	700	240	320	140	050534

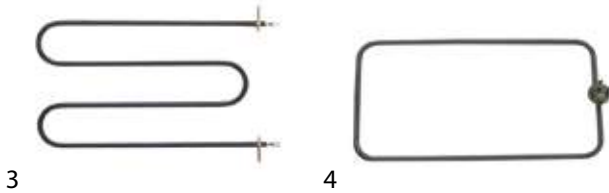

fig.	Vare nr.	P (W)	volt. (V)	L (mm)	W (mm)	Ref. No.
3	415293	1300	230	330	184	004910
4	415565	1500	230	350	180	0K9905

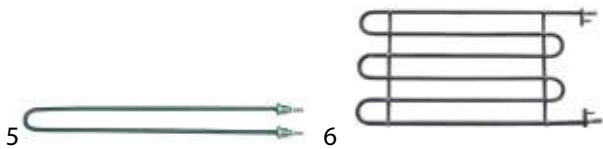

fig.	Vare nr.	P (W)	volt. (V)	L (mm)	W (mm)	Ref. No.
5	415051	1500	230	390	36	0H6163
6	415596	1500	230	395	198	0G2290

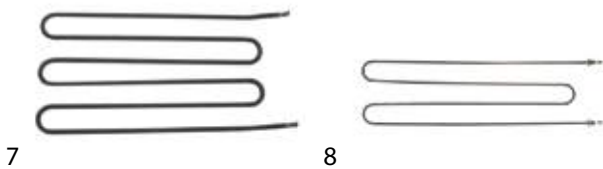

fig.	Vare nr.	P (W)	volt. (V)	L (mm)	W (mm)	Ref. No.
7	415353	1500	230	395	205	050933
8	415350	1600	400	610	180	0K4982



fig.	Vare nr.	P (W)	volt. (V)	L (mm)	W (mm)	Ref. No.
9	415212	2000	400	320	96	0H6201
10	415074	2300	230	641	180	051998

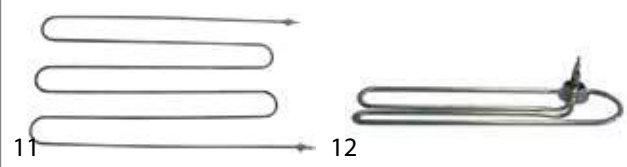

fig.	Vare nr.	P (W)	volt. (V)	L (mm)	W (mm)	Ref. No.
11	415624	2400	400	605	380	0K4984
12	415908	2500	230	385	96	0G5201

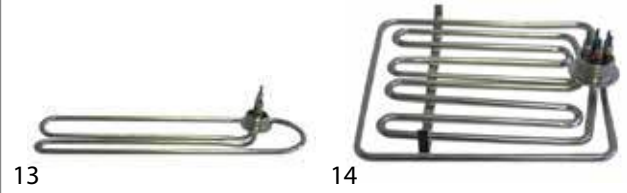

fig.	Vare nr.	P (W)	volt. (V)	L (mm)	W (mm)	Ref. No.
13	415481	2500	400	385	96	0K0566
14	415650	6000	230	255	250	0K0593

Emainox

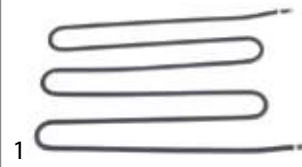

fig.	Vare nr.	P (W)	volt. (V)	L (mm)	W (mm)	Ref. No.
1	418344	1200	220	395	220	3710003

Emmepi

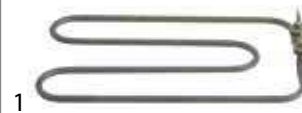

fig.	Vare nr.	P (W)	volt. (V)	L (mm)	W (mm)	Ref. No.
1	416067	1380	230	346	190	808174

GGX



fig.	Vare nr.	P (W)	volt. (V)	L (mm)	W (mm)	Ref. No.
1	415789	2200	400	550	155	—

GIGA



fig.	Vare nr.	P (W)	volt. (V)	L (mm)	W (mm)	Ref. No.
1	416244	1000	230	258	34	Y19700
2	415130	1500	230	412	50	X45800



3

fig.	Vare nr.	P (W)	volt. (V)	L (mm)	W (mm)	Ref. No.
3	415844	2600	230	410	300	X45900

Giorik

1

fig.	Vare nr.	P (W)	volt. (V)	L (mm)	W (mm)	Ref. No.
1	416067	1380	230	346	190	6001024

Haka

1

fig.	Vare nr.	P (W)	volt. (V)	L (mm)	W (mm)	Ref. No.
1	415428	1500	230	292	50	9007

Herzog&Langen

1 **2**

fig.	Vare nr.	P (W)	volt. (V)	L (mm)	W (mm)	Ref. No.
1	415453	2000	230	248	248	342120.532
1	415454	2000	400	244	244	342130.532
2	415789	2200	400	550	155	340810.532

Inomak

1

fig.	Vare nr.	P (W)	volt. (V)	L (mm)	W (mm)	Ref. No.
1	420033	1300	230	385	440	34500040100070
1	420032	2000	230	385	440	34500040100541

Juno

1 **2**

fig.	Vare nr.	P (W)	volt. (V)	L (mm)	W (mm)	Ref. No.
1	415051	1500	230	390	36	0H6163
2	415596	1500	230	395	198	0G2290

3 **4**

fig.	Vare nr.	P (W)	volt. (V)	L (mm)	W (mm)	Ref. No.
3	415353	1500	230	395	205	050933
4	415212	2000	400	320	96	0H6201

5 **6**

fig.	Vare nr.	P (W)	volt. (V)	L (mm)	W (mm)	Ref. No.
5	415908	2500	230	385	96	0G5201
6	415481	2500	400	385	96	0K0566

7

fig.	Vare nr.	P (W)	volt. (V)	L (mm)	W (mm)	Ref. No.
7	415650	6000	230	255	250	0K0593

King

1

fig.	Vare nr.	P (W)	volt. (V)	L (mm)	W (mm)	Ref. No.
1	415565	1500	230	350	180	0K9905



Krefft

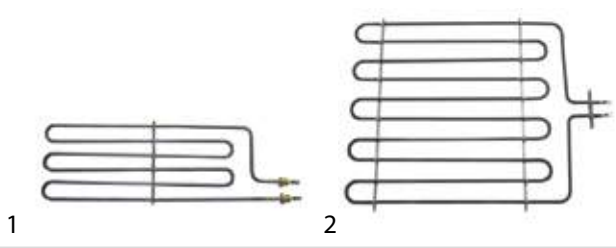

fig.	Vare nr.	P (W)	volt. (V)	L (mm)	W (mm)	Ref. No.
1	415608	2000	230	430	135	49-182403
1	415609	2000	400	430	135	49-182404
2	415988	3000	230	420	330	49-182328
2	415589	3000	400	420	330	49-182327

Küppersbusch

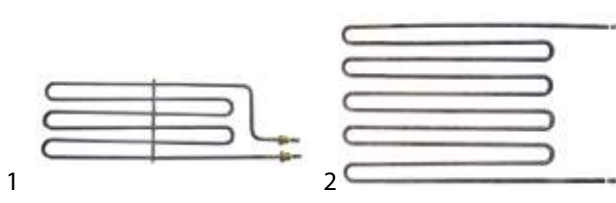

fig.	Vare nr.	P (W)	volt. (V)	L (mm)	W (mm)	Ref. No.
1	415608	2000	230	430	135	182403
1	415609	2000	400	430	135	182404
2	416936	2000	230	470	246	540635

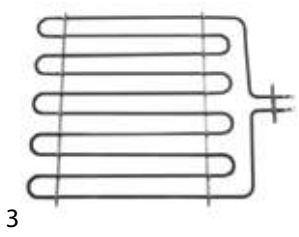

fig.	Vare nr.	P (W)	volt. (V)	L (mm)	W (mm)	Ref. No.
3	415988	3000	230	420	330	182328
3	415589	3000	400	420	330	182327

Lotus

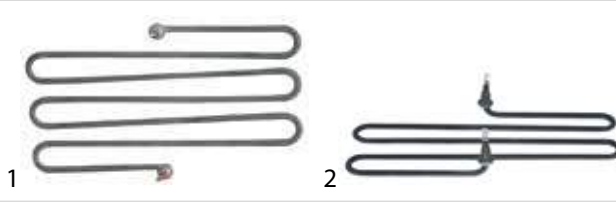

fig.	Vare nr.	P (W)	volt. (V)	L (mm)	W (mm)	Ref. No.
1	416194	1189	230	278	150	537004800
2	415700	1300	230	280	110	—

Malag



fig.	Vare nr.	P (W)	volt. (V)	L (mm)	W (mm)	Ref. No.
1	415323	1600	230	383	96	105619

Mareno

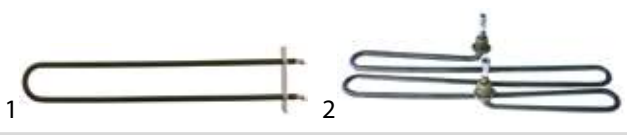

fig.	Vare nr.	P (W)	volt. (V)	L (mm)	W (mm)	Ref. No.
1	418694	750	230	410	63	CR0502320
2	415091	1000	230	295	85	MA1037039513

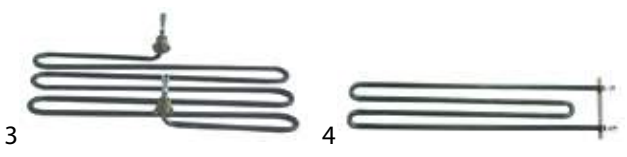

fig.	Vare nr.	P (W)	volt. (V)	L (mm)	W (mm)	Ref. No.
3	415092	1300	230	290	130	MA1037039613
4	415979	1500	230	497	90	MA1634100
4	415992	1800	230	495	90	MA1634200
4	415083	2100	220	500	90	MA1634300



fig.	Vare nr.	P (W)	volt. (V)	L (mm)	W (mm)	Ref. No.
5	415081	1800	240	500	34	MA627510
6	415082	2200	230	410	34	33610

MBM-Italia

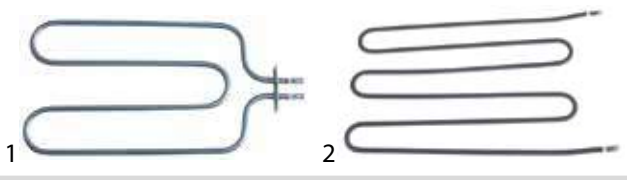

fig.	Vare nr.	P (W)	volt. (V)	L (mm)	W (mm)	Ref. No.
1	418471	600	230	355	215	RTFOC00584
1	416554	1500	230	355	203	RTCU700280
2	418344	1200	220	395	220	3710003



fig.	Vare nr.	P (W)	volt. (V)	L (mm)	W (mm)	Ref. No.
3	416555	2000	240	570	92	RTBE800038

MKN

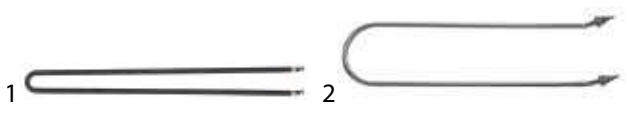

fig.	Vare nr.	P (W)	volt. (V)	L (mm)	W (mm)	Ref. No.
1	418314	950	230	390	36	573011
1	418303	1200	230	510	45	574107
1	420420	1200	230	545	40	574145
2	415449	1000	220	290	177	573007
2	415420	1500	220	443	114	573000

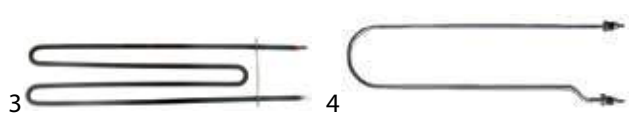



fig.	Vare nr.	P (W)	volt. (V)	L (mm)	W (mm)	Ref. No.
3	418302	1000	230	412	100	203492
4	415816	1000	230	445	135	573002
4	415421	1500	220	445	135	573004

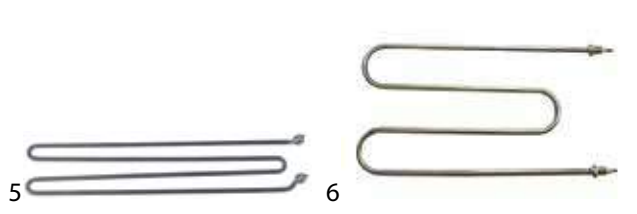

fig.	Vare nr.	P (W)	volt. (V)	L (mm)	W (mm)	Ref. No.
5	419055	1750	400	490	88.5	573020
6	415419	2000	230	405	218.5	573006

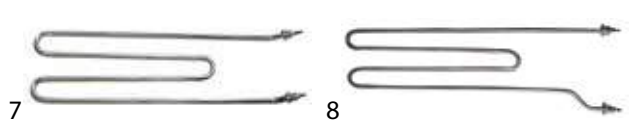

fig.	Vare nr.	P (W)	volt. (V)	L (mm)	W (mm)	Ref. No.
7	415821	3000	230	420	125	573012
8	415780	3000	230	465	140	573096

Modular

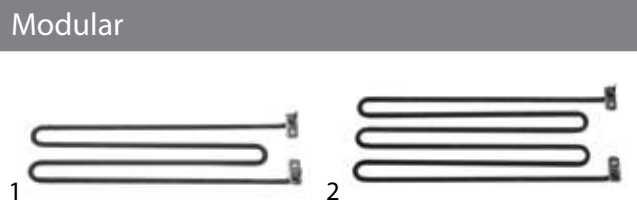

fig.	Vare nr.	P (W)	volt. (V)	L (mm)	W (mm)	Ref. No.
1	415927	1200	240	405	88	66500400
2	415926	1800	240	403	128	66500300
2	416537	2200	230	523	134	96500100

Morice



fig.	Vare nr.	P (W)	volt. (V)	L (mm)	W (mm)	Ref. No.
1	420012	850	230	420	40	RS0905

Multi

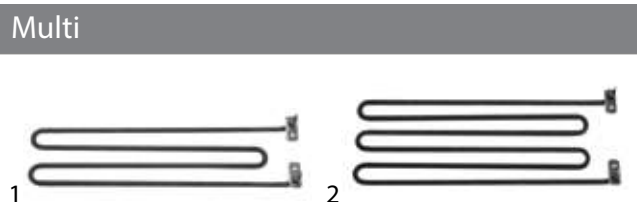

fig.	Vare nr.	P (W)	volt. (V)	L (mm)	W (mm)	Ref. No.
1	415927	1200	240	405	88	665004
2	415926	1800	240	403	128	665003

Nayati



fig.	Vare nr.	P (W)	volt. (V)	L (mm)	W (mm)	Ref. No.
1	418431	1000	230	402	246	PD411J

Olis

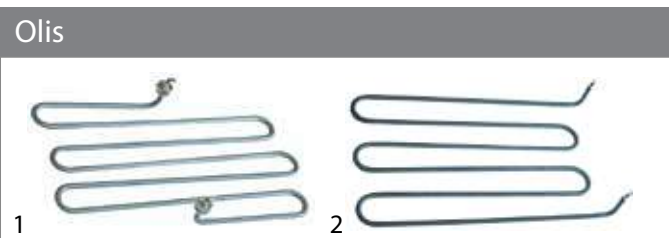

fig.	Vare nr.	P (W)	volt. (V)	L (mm)	W (mm)	Ref. No.
1	416796	1500	240	325	180	BN6A045700
2	416797	2000	230	480	275	BN6A037050

Palux

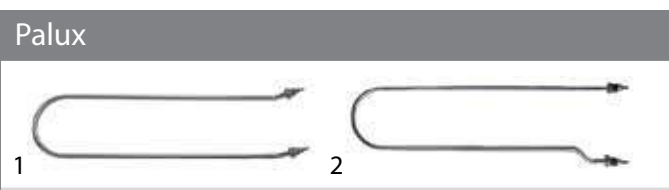

fig.	Vare nr.	P (W)	volt. (V)	L (mm)	W (mm)	Ref. No.
1	415420	1500	220	443	114	290653
2	415421	1500	220	445	135	290661



fig.	Vare nr.	P (W)	volt. (V)	L (mm)	W (mm)	Ref. No.
3	415434	1500	230	342	79	056928

Repagas



fig.	Vare nr.	P (W)	volt. (V)	L (mm)	W (mm)	Ref. No.
1	420216	1500	230	490	92	22300016

Rieber



fig.	Vare nr.	P (W)	volt. (V)	L (mm)	W (mm)	Ref. No.
1	415545	855	240	380	204	33010111



RM-Gastro

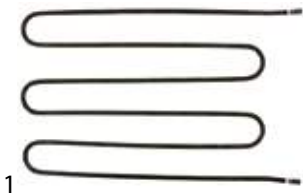

fig.	Vare nr.	P (W)	volt. (V)	L (mm)	W (mm)	Ref. No.
1	418668	700	230	370	230	401021700
1	416195	1500	230	368	268	401023000

Roka

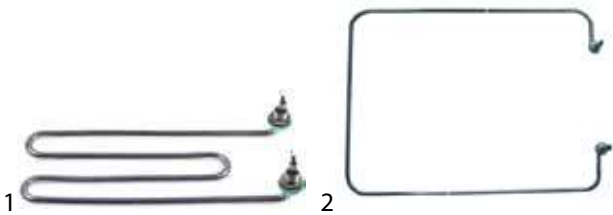

fig.	Vare nr.	P (W)	volt. (V)	L (mm)	W (mm)	Ref. No.
1	415675	2000	230	250	100	14181
2	415669	2000	230	452	256	14997



fig.	Vare nr.	P (W)	volt. (V)	L (mm)	W (mm)	Ref. No.
3	415375	3000	230	257	165	10982

Roller Grill

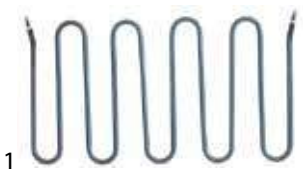

fig.	Vare nr.	P (W)	volt. (V)	L (mm)	W (mm)	Ref. No.
1	416778	1500	230	246	430	D02073

Rosinox



fig.	Vare nr.	P (W)	volt. (V)	L (mm)	W (mm)	Ref. No.
1	415091	1000	230	295	85	RX94812669

Saro

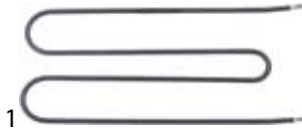

fig.	Vare nr.	P (W)	volt. (V)	L (mm)	W (mm)	Ref. No.
1	420070	1200	230	385	180	94-8095019

Scholl

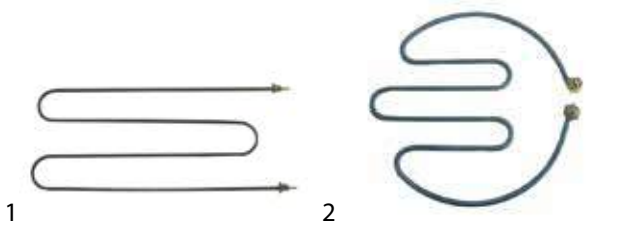

fig.	Vare nr.	P (W)	volt. (V)	L (mm)	W (mm)	Ref. No.
1	420290	1000	230	415	198	71,01,35
1	415635	1000	230	455	210	71,20,06
2	415750	1500	230	245	235	71,20,70

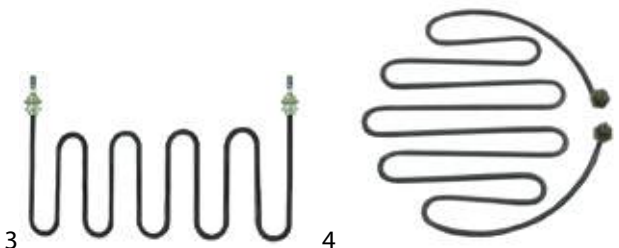

fig.	Vare nr.	P (W)	volt. (V)	L (mm)	W (mm)	Ref. No.
3	418342	2000	230	207	413	71,20,23
4	415751	2200	230	251	245	VZ 12806 71,20,71

Silko



fig.	Vare nr.	P (W)	volt. (V)	L (mm)	W (mm)	Ref. No.
1	415130	1500	230	412	50	SIR0109060
2	415992	1800	230	495	90	MA1634200

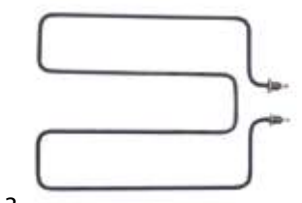

fig.	Vare nr.	P (W)	volt. (V)	L (mm)	W (mm)	Ref. No.
3	415844	2600	230	410	300	SIR0109061



Solymac



fig.	Vare nr.	P (W)	volt. (V)	L (mm)	W (mm)	Ref. No.
1	418448	900	230	367	122	P31

SSG



fig.	Vare nr.	P (W)	volt. (V)	L (mm)	W (mm)	Ref. No.
1	415451	1500	230	325	136	—

Stahl

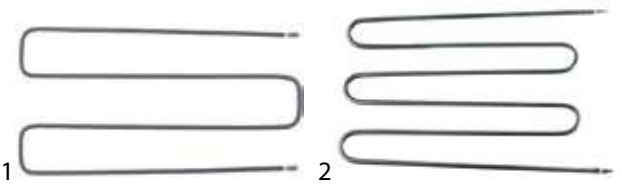

fig.	Vare nr.	P (W)	volt. (V)	L (mm)	W (mm)	Ref. No.
1	415545	855	240	380	204	160025
2	418280	1200	230	410	233	160031

Star10



fig.	Vare nr.	P (W)	volt. (V)	L (mm)	W (mm)	Ref. No.
1	416161	1000	230	430	95	071027
2	415130	1500	230	412	50	X45800

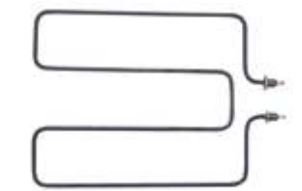

fig.	Vare nr.	P (W)	volt. (V)	L (mm)	W (mm)	Ref. No.
3	415844	2600	230	410	300	X45900

Tecnoinox

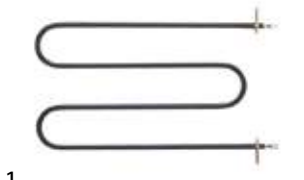

fig.	Vare nr.	P (W)	volt. (V)	L (mm)	W (mm)	Ref. No.
1	415293	1300	230	330	184	RC00269000

Therma

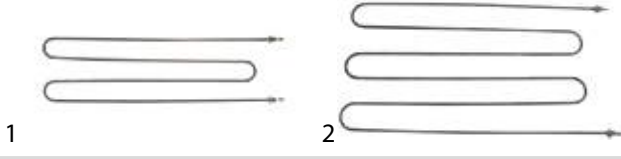

fig.	Vare nr.	P (W)	volt. (V)	L (mm)	W (mm)	Ref. No.
1	415350	1600	400	610	180	0K4982
2	415624	2400	400	605	380	0K4984

Ubert

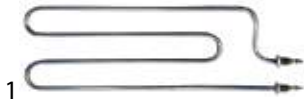

fig.	Vare nr.	P (W)	volt. (V)	L (mm)	W (mm)	Ref. No.
1	415567	2000	230	425	145	343102

VEGA

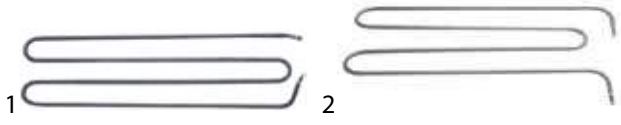

fig.	Vare nr.	P (W)	volt. (V)	L (mm)	W (mm)	Ref. No.
1	416161	1000	230	430	95	92023
2	418502	1200	230	410	195	92028

Zanussi

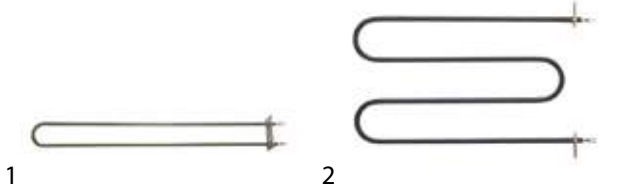

fig.	Vare nr.	P (W)	volt. (V)	L (mm)	W (mm)	Ref. No.
1	415096	550	230	438	44	0A2197
1	415097	800	230	630	44	0A2137
2	415293	1300	230	330	184	004910

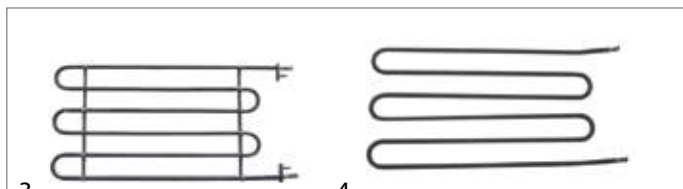

fig.	Vare nr.	P (W)	volt. (V)	L (mm)	W (mm)	Ref. No.
3	415596	1500	230	395	198	0G2290
4	415353	1500	230	395	205	050933



fig.	Vare nr.	P (W)	volt. (V)	L (mm)	W (mm)	Ref. No.
5	415074	2300	230	641	180	051998

heating elements for frying pans

Ambach

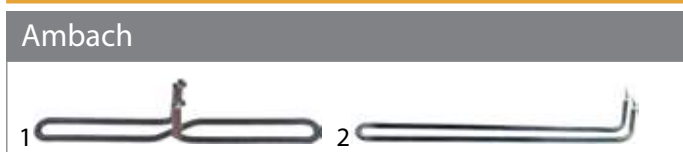

fig.	Vare nr.	P (W)	volt. (V)	L (mm)	W (mm)	Ref. No.
1	420073	1300	400	418	42	5060820841
2	416961	1500	230	530	45	5060814355

Bonnet



fig.	Vare nr.	P (W)	volt. (V)	L (mm)	W (mm)	Ref. No.
1	420432	1600	230	90	556	302197

Capic



fig.	Vare nr.	P (W)	volt. (V)	L (mm)	W (mm)	Ref. No.
1	418939	2500	230	575	115	E151112
1	418940	3500	230	515	150	E151455

Electrolux



fig.	Vare nr.	P (W)	volt. (V)	L (mm)	W (mm)	Ref. No.
1	415184	2000	230	570	86	059401

Lotus



fig.	Vare nr.	P (W)	volt. (V)	L (mm)	W (mm)	Ref. No.
1	415771	2000	230	280	170	537015100
2	418072	2000	230	498	92	537029500

MKN



fig.	Vare nr.	P (W)	volt. (V)	L (mm)	W (mm)	Ref. No.
1	418279	1200	230	502	50	574113

Morice



fig.	Vare nr.	P (W)	volt. (V)	L (mm)	W (mm)	Ref. No.
1	420258	5500	230	560	185	RS0960

Palux

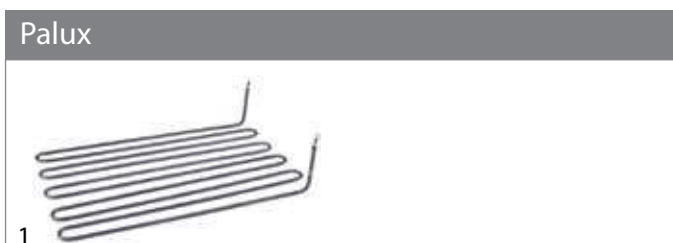

fig.	Vare nr.	P (W)	volt. (V)	L (mm)	W (mm)	Ref. No.
1	416899	3500	230	430	245	501816

Thirode



fig.	Vare nr.	P (W)	volt. (V)	L (mm)	W (mm)	Ref. No.
1	420432	1600	230	90	556	302197

Zanussi



fig.	Vare nr.	P (W)	volt. (V)	L (mm)	W (mm)	Ref. No.
1	415184	2000	230	570	86	059401



heating elements for crepes makers

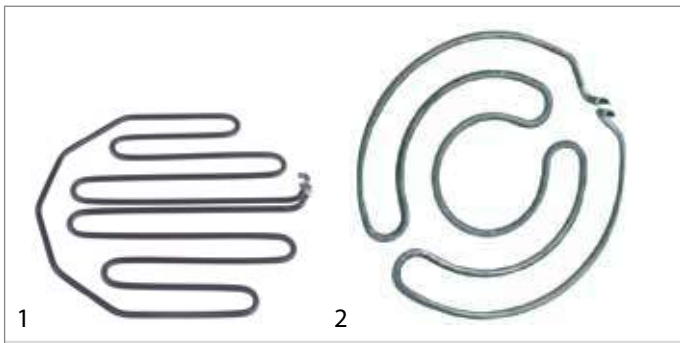

fig.	Vare nr.	P (W)	volt. (V)	L (mm)	W (mm)	H (mm)	tube ø (mm)	suitable for	Ref. No.
1	418646	2000	230	270	235	45	6.3	Cookmax Sirman	IGS703103 IGS703103
2	416636	2000	230	280	-	34	9	Dihl Faba Fimar Kromo	DW6006 PR30001 CO1765 DW6006

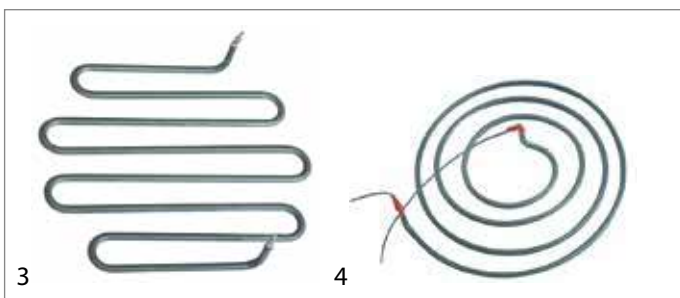

fig.	Vare nr.	P (W)	volt. (V)	L (mm)	W (mm)	H (mm)	tube ø (mm)	suitable for	Ref. No.
3	416157	2400	230	305	250	60	8.5	Anitec Star10	071066 071066
4	416726	3000	230	304	300	65	8.5	Roller Grill	D02013

heating elements for chip scuttles

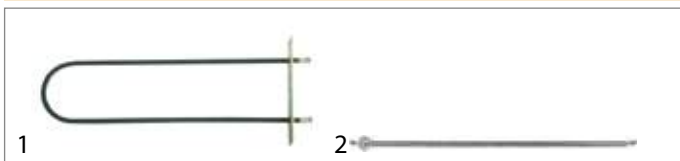

fig.	Vare nr.	P (W)	volt. (V)	L (mm)	W (mm)	suitable for	Ref. No.
1	416082	350	230	172	74	Bertos GIGA Star10	22016400 X48400 X48400
1	416832	650	230	276	73	Rosinox Silko	RX94812603 SIR0109049
2	420162	500	230	442	-	Capic	E150510

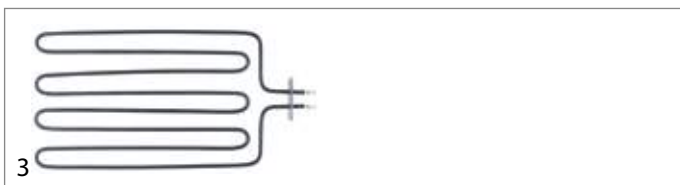

fig.	Vare nr.	P (W)	volt. (V)	L (mm)	W (mm)	suitable for	Ref. No.
3	418037	700	230	425	220	Baron Cookmax	41826620031 41826620031

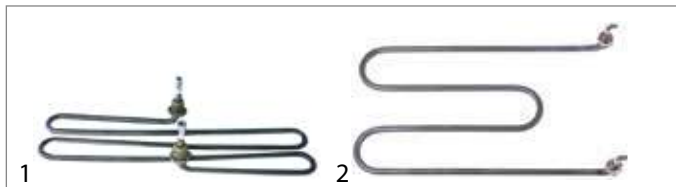

fig.	Vare nr.	P (W)	volt. (V)	L (mm)	W (mm)	suitable for	Ref. No.
1	415091	1000	230	295	85	Baron Cookmax EKU Mareno Rosinox	MA1037039513 1037039513 1W217 MA1037039513 RX94812669
2	418252	1000	230	330	177	Haka	9008

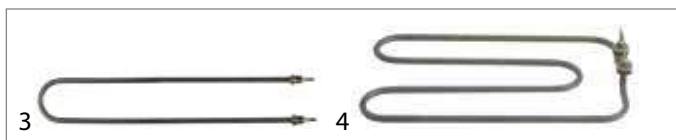

fig.	Vare nr.	P (W)	volt. (V)	L (mm)	W (mm)	suitable for	Ref. No.
3	418315	1000	230	385	68	MKN	574054
4	416067	1380	230	346	190	Bartscher Emmepi Giorik	06001024 808174 6001024



fig.	Vare nr.	P (W)	volt. (V)	L (mm)	W (mm)	suitable for	Ref. No.
1	418659	350	230	175	180	Cookmax RM-Gastro	401021000 401021000

heating elements for fryers

Ambach



fig.	Vare nr.	P (W)	volt. (V)	HC	L (mm)	W (mm)	H (mm)	Ref. No.
1	419211	7500	400	3	335	135	400	5060811194

Ambassade



fig.	Vare nr.	P (W)	volt. (V)	HC	L (mm)	W (mm)	H (mm)	Ref. No.
1	418488	2800	230	1	343	180	152	6537366

Angelo-Po



fig.	Vare nr.	P (W)	volt. (V)	HC	L (mm)	W (mm)	H (mm)	Ref. No.
1	416589	18000	400	3	395	270	32	32G2400



fig.	Vare nr.	P (W)	volt. (V)	HC	L (mm)	W (mm)	H (mm)	Ref. No.
1	415180	2050	230	1	305	53	245	32G1241
1	416588	4700	400	1	480	90	230	32G1181

Anitec

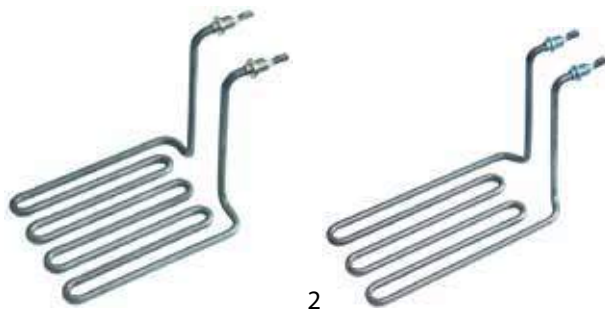

fig.	Vare nr.	P (W)	volt. (V)	HC	L (mm)	W (mm)	H (mm)	Ref. No.
1	416168	2500	230	1	222	154	175	071077
2	416167	2500	230	1	275	157	185	071055.1

HEATING ELEMENTS FOR FRYERS SUITABLE FOR

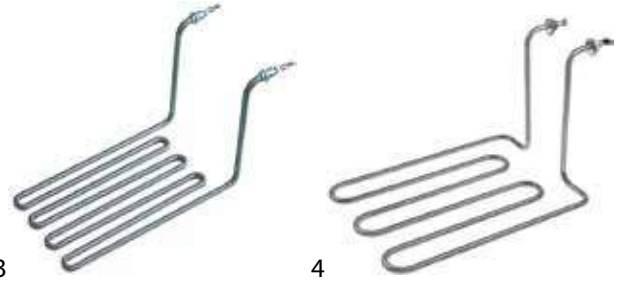

fig.	Vare nr.	P (W)	volt. (V)	HC	L (mm)	W (mm)	H (mm)	Ref. No.
3	416169	3000	230	1	290	160	185	071052
4	417567	3000	230	1	290	205	195	071001



fig.	Vare nr.	P (W)	volt. (V)	HC	L (mm)	W (mm)	H (mm)	Ref. No.
5	416172	3000	230	1	300	80	255	071005

Ascobloc



fig.	Vare nr.	P (W)	volt. (V)	HC	L (mm)	W (mm)	H (mm)	Ref. No.
1	415591	2000	230	1	285	40	240	9294087

Baron

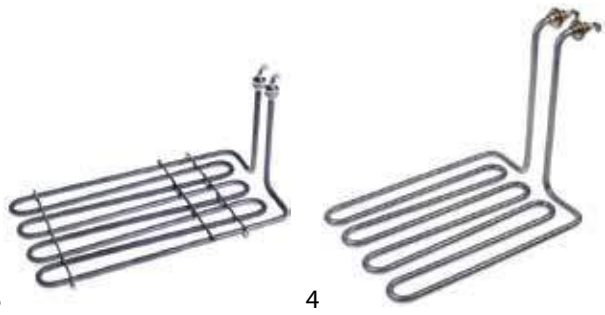

fig.	Vare nr.	P (W)	volt. (V)	HC	L (mm)	W (mm)	H (mm)	Ref. No.
1	415297	6800	230/400	3	299	107	35	BN4185326002136
2	416070	10200	230/400	3	300	180	33	85326002137

1

fig.	Vare nr.	P (W)	volt. (V)	HC	L (mm)	W (mm)	H (mm)	Ref. No.
1	418713	9000	230/400	3	395	135	267	BN9000482
1	418710	13000	230/400	3	385	200	270	BN9000483



3 4

fig.	Vare nr.	P (W)	volt. (V)	HC	L (mm)	W (mm)	H (mm)	Ref. No.
3	418488	2800	230	1	343	180	152	06537366
4	420018	3250	230	1	265	185	200	016210818



1

fig.	Vare nr.	P (W)	volt. (V)	HC	L (mm)	W (mm)	H (mm)	Ref. No.
1	416810	6000	230/400	3	320	175	205	MA1037317100
1	416811	9000	230	3	320	175	205	MA1037317200



5

fig.	Vare nr.	P (W)	volt. (V)	HC	L (mm)	W (mm)	H (mm)	Ref. No.
5	416811	9000	230	3	320	175	205	01037317200

Bartscher



1

fig.	Vare nr.	P (W)	volt. (V)	HC	L (mm)	W (mm)	H (mm)	Ref. No.
1	415297	6800	230/400	3	299	107	35	0211441

Baumeister



1

fig.	Vare nr.	P (W)	volt. (V)	HC	L (mm)	W (mm)	H (mm)	Ref. No.
1	415423	2000	230	1	320	40	215	7300000148

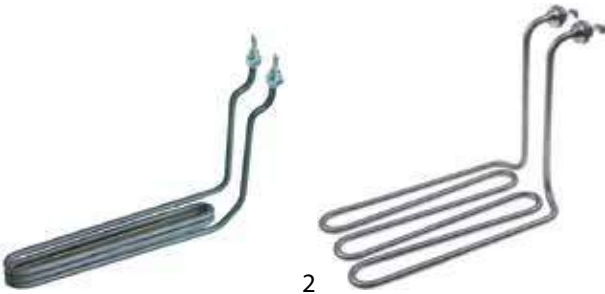

1 2

fig.	Vare nr.	P (W)	volt. (V)	HC	L (mm)	W (mm)	H (mm)	Ref. No.
1	416800	2300	230	1	340	42	210	08208200
2	420145	2500	230	1	267	127	187	016240419

Bertos



1

fig.	Vare nr.	P (W)	volt. (V)	HC	L (mm)	W (mm)	H (mm)	Ref. No.
1	416008	5000	230/400	3	245	200	170	33026600
1	418104	6000	230/400	3	280	202	170	33026700
1	418106	9000	230/400	3	300	240	200	33026900



1

fig.	Vare nr.	P (W)	volt. (V)	HC	L (mm)	W (mm)	H (mm)	Ref. No.
1	415257	6000	230/400	3	300	182	252	22016200

1

fig.	Vare nr.	P (W)	volt. (V)	HC	L (mm)	W (mm)	H (mm)	Ref. No.
1	420186	7000	230	3	393	245	210	RC3017
1	420185	12000	230	3	415	237	213	RC3018

1

fig.	Vare nr.	P (W)	volt. (V)	HC	L (mm)	W (mm)	H (mm)	Ref. No.
1	416004	2700	230	1	240	208	125	33024700
1	416006	3100	230	1	270	215	131	33024800
1	420068	3450	400	1	290	180	153	33025900
1	416007	3500	230	1	290	190	153	33025600

Capic

1

fig.	Vare nr.	P (W)	volt. (V)	HC	L (mm)	W (mm)	H (mm)	Ref. No.
1	418957	4000	230	1	475	80	280	E152009

Bonnet

1

fig.	Vare nr.	P (W)	volt. (V)	HC	L (mm)	W (mm)	H (mm)	Ref. No.
1	418914	4000	230	1	500	64	290	322523

1

fig.	Vare nr.	P (W)	volt. (V)	HC	L (mm)	W (mm)	H (mm)	Ref. No.
1	418958	8000	220	3	490	230	270	E152050

Bourgeois

1

fig.	Vare nr.	P (W)	volt. (V)	HC	L (mm)	W (mm)	H (mm)	Ref. No.
1	420184	3500	230	1	294	170	208	RC3000

Capito

1

fig.	Vare nr.	P (W)	volt. (V)	HC	L (mm)	W (mm)	H (mm)	Ref. No.
1	415740	3000	230	1	305	145	280	63852

CF-Cenedese

fig.	Vare nr.	P (W)	volt. (V)	HC	L (mm)	W (mm)	H (mm)	Ref. No.
1	415720	1400	230	1	275	40	210	63.7.1068
2	415721	2100	230	1	292	107	200	63.7.1064

fig.	Vare nr.	P (W)	volt. (V)	HC	L (mm)	W (mm)	H (mm)	Ref. No.
3	418665	5000	230	1	473	250	190	401003000
4	416810	6000	230/400	3	320	175	205	1037317100
4	416811	9000	230	3	320	175	205	1037317200

Cookmax

fig.	Vare nr.	P (W)	volt. (V)	HC	L (mm)	W (mm)	H (mm)	Ref. No.
1	418713	9000	230/400	3	395	135	267	9000482
1	418710	13000	230/400	3	385	200	270	9000483
2	420063	13000	230/400	3	385	200	245	9000481

Dexion

fig.	Vare nr.	P (W)	volt. (V)	HC	L (mm)	W (mm)	H (mm)	Ref. No.
1	416889	2000	230	1	310	73	225	180588

fig.	Vare nr.	P (W)	volt. (V)	HC	L (mm)	W (mm)	H (mm)	Ref. No.
1	418654	2100	230	1	270	120	200	401001000
1	418669	3000	230	1	270	110	200	401002000
1	418671	3000	230	1	300	120	215	401002520
2	418655	3000	230	1	275	175	200	401002500
2	418670	3000	230	1	310	175	220	401002510

EGO

fig.	Vare nr.	P (W)	volt. (V)	HC	L (mm)	W (mm)	H (mm)	Ref. No.
1	416995	2900	230	1	270	50	246	20.40629.000
1	416994	2900	230	1	310	60	195	20.40453.000

fig.	Vare nr.	P (W)	volt. (V)	HC	L (mm)	W (mm)	H (mm)	Ref. No.
1	418630	6900	400	3	375	170	255	20.27543.010



fig.	Vare nr.	P (W)	volt. (V)	HC	L (mm)	W (mm)	H (mm)	Ref. No.
1	415423	2000	230	1	320	40	215	20.26704.000

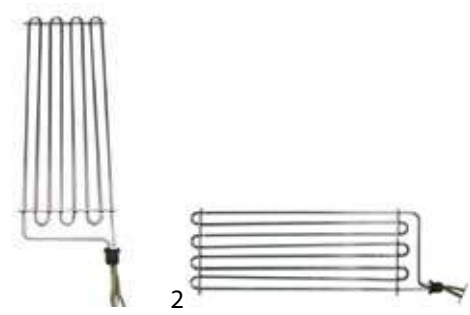

fig.	Vare nr.	P (W)	volt. (V)	HC	L (mm)	W (mm)	H (mm)	Ref. No.
1	415370	8000	230/400	3	555	177	27	0K0621
2	415371	8000	230/400	3	555	177	27	0H6194

EKU



fig.	Vare nr.	P (W)	volt. (V)	HC	L (mm)	W (mm)	H (mm)	Ref. No.
1	415090	5500	230/400	3	320	200	210	1-W-218
1	420289	7500	220	3	320	196	215	4-102



fig.	Vare nr.	P (W)	volt. (V)	HC	L (mm)	W (mm)	H (mm)	Ref. No.
1	415490	5100	230/400	3	345	168	246	0H6192
2	415611	7200	230/400	3	350	168	249	0H6203

Electrolux



fig.	Vare nr.	P (W)	volt. (V)	HC	L (mm)	W (mm)	H (mm)	Ref. No.
1	420124	2900	230	1	233	77	245	004628
2	416995	2900	230	1	270	50	246	0A5565
2	416994	2900	230	1	310	60	195	005964



fig.	Vare nr.	P (W)	volt. (V)	HC	L (mm)	W (mm)	H (mm)	Ref. No.
1	415291	2000	230	1	250	45	190	004926
2	415470	2000	230	1	320	36	265	0H6180
2	415498	2500	230	1	315	40	275	0K0569



fig.	Vare nr.	P (W)	volt. (V)	HC	L (mm)	W (mm)	H (mm)	Ref. No.
3	415274	3000	230	1	400	70	270	058615
4	415377	5500	230	1	320	86	248	059563
4	418002	5500	400	1	320	86	248	006571



fig.	Vare nr.	P (W)	volt. (V)	HC	L (mm)	W (mm)	H (mm)	Ref. No.
1	418340	11000	400	3	285	150	255	0K5928



Elettrobar

fig.	Vare nr.	P (W)	volt. (V)	HC	L (mm)	W (mm)	H (mm)	Ref. No.
1	416499	3300	230	1	249	128	210	230069
1	416504	3300	230	1	320	131	220	230070
2	416506	6600	230/400	3	342	127	230	230072

Elframo

fig.	Vare nr.	P (W)	volt. (V)	HC	L (mm)	W (mm)	H (mm)	Ref. No.
1	415921	1260	230	1	320	48	220	00033130
1	415920	2800	230	1	280	160	185	00033120
2	420210	1600	230	1	283	75	200	00039276

fig.	Vare nr.	P (W)	volt. (V)	HC	L (mm)	W (mm)	H (mm)	Ref. No.
3	415923	2000	230	1	315	74	250	00033141
4	415924	3000	230	1	297	86	243	00033142

fig.	Vare nr.	P (W)	volt. (V)	HC	L (mm)	W (mm)	H (mm)	Ref. No.
5	416782	3333	230	1	395	85	245	00033151
5	416783	5500	230	1	250	60	250	00033154
6	420209	9000	230	3	310	180	235	00039278

Emmepi

fig.	Vare nr.	P (W)	volt. (V)	HC	L (mm)	W (mm)	H (mm)	Ref. No.
1	415297	6800	230/400	3	299	107	35	808689
2	416070	10200	230/400	3	300	180	33	808256

Fagor

fig.	Vare nr.	P (W)	volt. (V)	HC	L (mm)	W (mm)	H (mm)	Ref. No.
1	416824	7000	230/400	3	325	110	33	FAG6000001

fig.	Vare nr.	P (W)	volt. (V)	HC	L (mm)	W (mm)	H (mm)	Ref. No.
1	416627	1500	230	1	300	50	180	12024653
1	416625	2000	230	1	310	50	180	12024654
2	416628	2000	230	1	298	49	179	X373005000

fig.	Vare nr.	P (W)	volt. (V)	HC	L (mm)	W (mm)	H (mm)	Ref. No.
3	416622	3000	230	1	303	45	190	12024670
3	416630	3000	230	1	335	47	226	12024695
3	416631	4250						X393010000
4	416632	4250	230	1	380	104	230	12024745

fig.	Vare nr.	P (W)	volt. (V)	HC	L (mm)	W (mm)	H (mm)	Ref. No.
1	420157	2750	230	1	298	150		12024661
2	417166	4000	230	1	295	90	290	12024707
2	416548	4000	230	1	300	85	300	12024704
2	417160	6000	230	1	380	90	355	12024757

fig.	Vare nr.	P (W)	volt. (V)	HC	L (mm)	W (mm)	H (mm)	Ref. No.
1	419112	6000	230	3	385	200	285	12004358

Fimar

fig.	Vare nr.	P (W)	volt. (V)	HC	L (mm)	W (mm)	H (mm)	Ref. No.
1	416744	2000	230	1	282	120	175	CO1116
2	418643	3200	230	1	290	185	165	CO1117

Forved

fig.	Vare nr.	P (W)	volt. (V)	HC	L (mm)	W (mm)	H (mm)	Ref. No.
1	416890	1670	230	1	360	85	233	3111
1	416889	2000	230	1	310	73	225	3966
2	416891	3000	230	1	362	65	240	3108
2	416892	4000	230	1	347	85	235	3108A

fig.	Vare nr.	P (W)	volt. (V)	HC	L (mm)	W (mm)	H (mm)	Ref. No.
3	416888	3500	230	2	300	115	232	3955

FriFri

fig.	Vare nr.	P (W)	volt. (V)	HC	L (mm)	W (mm)	H (mm)	Ref. No.
1	415738	2000	230	1	302	51	177	400533
2	415742	2300	230	1	280	90	180	100947

fig.	Vare nr.	P (W)	volt. (V)	HC	L (mm)	W (mm)	H (mm)	Ref. No.
3	416424	3200	230	1	297	180	161	300915
4	415741	7500	230/400	3	310	130	295	101105

fig.	Vare nr.	P (W)	volt. (V)	HC	L (mm)	W (mm)	H (mm)	Ref. No.
5	416426	11400	230/400	3	310	215	298	300950



GIGA

fig.	Vare nr.	P (W)	volt. (V)	HC	L (mm)	W (mm)	H (mm)	Ref. No.
1	415257	6000	230/400	3	300	182	252	X46200
2	416409	7500	230/400	3	315	170	190	X57000

Giorik

fig.	Vare nr.	P (W)	volt. (V)	HC	L (mm)	W (mm)	H (mm)	Ref. No.
1	415297	6800	230/400	3	299	107	35	6002136
1	416824	7000	230/400	3	325	110	33	6002150
2	416070	10200	230/400	3	300	180	33	6002137
2	416825	12000	230/400	3	326	180	31	6002151

fig.	Vare nr.	P (W)	volt. (V)	HC	L (mm)	W (mm)	H (mm)	Ref. No.
1	418652	1700	230	1	290	130		AER001ZR10
2	416054	1700	230	1	320	70	215	X46600

fig.	Vare nr.	P (W)	volt. (V)	HC	L (mm)	W (mm)	H (mm)	Ref. No.
3	416826	16500	230/400	3	325	255	32	6002152

fig.	Vare nr.	P (W)	volt. (V)	HC	L (mm)	W (mm)	H (mm)	Ref. No.
3	416411	2500	230	1	290	55	165	Y19600
4	416055	3000	230	1	335	65	223	X46500

Haka

fig.	Vare nr.	P (W)	volt. (V)	HC	L (mm)	W (mm)	H (mm)	Ref. No.
1	415627	3500	400	1	230	74	258	9001
2	415631	4000	400	1	300	68	178	9048

fig.	Vare nr.	P (W)	volt. (V)	HC	L (mm)	W (mm)	H (mm)	Ref. No.
5	416053	1335-1450	230-240	1	317	42	190	X46100

fig.	Vare nr.	P (W)	volt. (V)	HC	L (mm)	W (mm)	H (mm)	Ref. No.
3	415629	4500	400	1	310	186	260	9003
3	415630	6000	400	1	296	250	255	9004
4	415632	6000	400	1	242	122	218	9049

Herzog&Langen



fig.	Vare nr.	P (W)	volt. (V)	HC	L (mm)	W (mm)	H (mm)	Ref. No.
1	415640	1700	230	1	280	55	212	345910532

Hualing

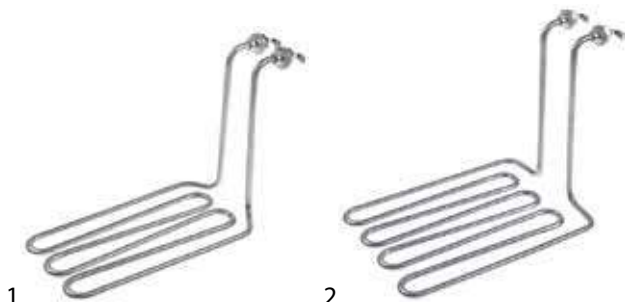

fig.	Vare nr.	P (W)	volt. (V)	HC	L (mm)	W (mm)	H (mm)	Ref. No.
1	417598	2500	230	1	290	130	200	GDF1104-13
2	417599	3250	230	1	280	190	210	HDF1108-13

Imperial-Germany



fig.	Vare nr.	P (W)	volt. (V)	HC	L (mm)	W (mm)	H (mm)	Ref. No.
1	415745	6000	400	3	365	180	246	8019117

Inoksan



fig.	Vare nr.	P (W)	volt. (V)	HC	L (mm)	W (mm)	H (mm)	Ref. No.
1	415377	5500	230	1	320	86	248	10070020

Juno

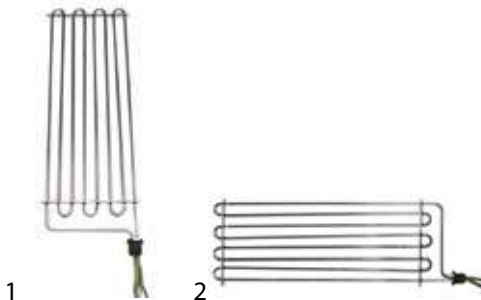

fig.	Vare nr.	P (W)	volt. (V)	HC	L (mm)	W (mm)	H (mm)	Ref. No.
1	415370	8000	230/400	3	555	177	27	0K0621
2	415371	8000	230/400	3	555	177	27	0H6194



fig.	Vare nr.	P (W)	volt. (V)	HC	L (mm)	W (mm)	H (mm)	Ref. No.
1	415490	5100	230/400	3	345	168	246	0H6192
2	415611	7200	230/400	3	350	168	249	0H6203

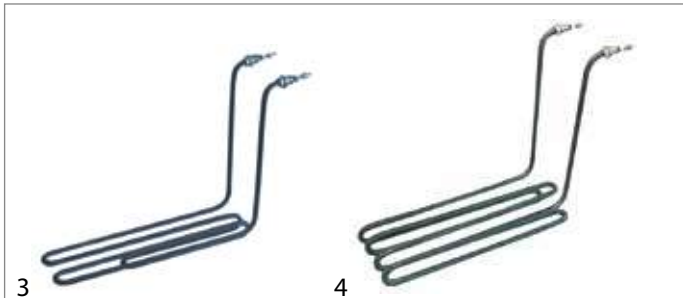

fig.	Vare nr.	P (W)	volt. (V)	HC	L (mm)	W (mm)	H (mm)	Ref. No.
1	415470	2000	230	1	320	36	265	0H6180
1	415498	2500	230	1	315	40	275	0K0569

Komel

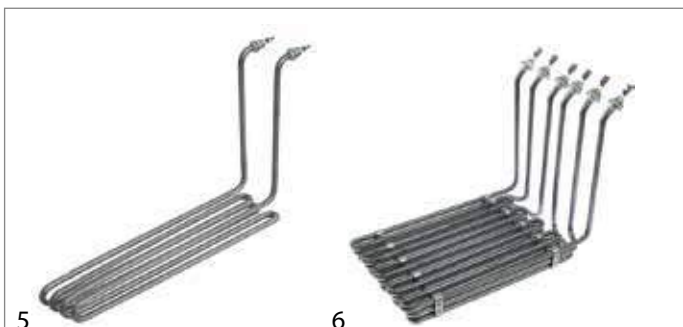

fig.	Vare nr.	P (W)	volt. (V)	HC	L (mm)	W (mm)	H (mm)	Ref. No.
1	415921	1260	230	1	320	48	220	00033130
1	415920	2800	230	1	280	160	185	00033120
2	420210	1600	230	1	283	75	200	00039276

3 4

fig.	Vare nr.	P (W)	volt. (V)	HC	L (mm)	W (mm)	H (mm)	Ref. No.
3	415923	2000	230	1	315	74	250	00033141
4	415924	3000	230	1	297	86	243	00033142



5 6

fig.	Vare nr.	P (W)	volt. (V)	HC	L (mm)	W (mm)	H (mm)	Ref. No.
5	416782	3333	230	1	395	85	245	00033151
5	416783	5500	230	1	250	60	250	—
6	420209	9000	230	3	310	180	235	00039278

Krefftt



1

fig.	Vare nr.	P (W)	volt. (V)	HC	L (mm)	W (mm)	H (mm)	Ref. No.
1	415490	5100	230/400	3	345	168	246	01-214567



1

fig.	Vare nr.	P (W)	volt. (V)	HC	L (mm)	W (mm)	H (mm)	Ref. No.
1	415591	2000	230	1	285	40	240	49-182651
1	415978	3000	230	1	288	48	243	49-182652

Küppersbusch



1

fig.	Vare nr.	P (W)	volt. (V)	HC	L (mm)	W (mm)	H (mm)	Ref. No.
1	416910	8000	230/400	3	300	185	22	540558



1

fig.	Vare nr.	P (W)	volt. (V)	HC	L (mm)	W (mm)	H (mm)	Ref. No.
1	418263	7200	230/400	3	360	150	220	540441



1

fig.	Vare nr.	P (W)	volt. (V)	HC	L (mm)	W (mm)	H (mm)	Ref. No.
1	415591	2000	230	1	285	40	240	182651
1	415978	3000	230	1	288	48	243	182652

Lotus



1

fig.	Vare nr.	P (W)	volt. (V)	HC	L (mm)	W (mm)	H (mm)	Ref. No.
1	416525	9750	230/400	3	305	220	35	537021301

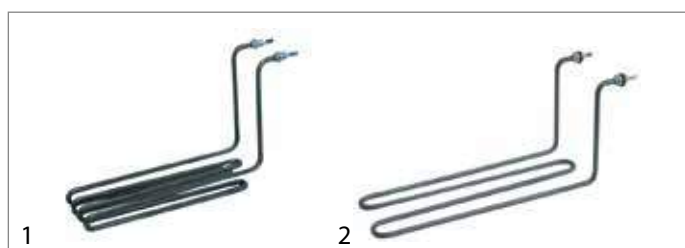

1 2

fig.	Vare nr.	P (W)	volt. (V)	HC	L (mm)	W (mm)	H (mm)	Ref. No.
1	415704	1800	230	1	310	60	200	537003500
2	416651	1800	230	1	388	127	172	537010800



3

fig.	Vare nr.	P (W)	volt. (V)	HC	L (mm)	W (mm)	H (mm)	Ref. No.
3	415705	2500	230	1	285	104	205	537003100

Malag



1

fig.	Vare nr.	P (W)	volt. (V)	HC	L (mm)	W (mm)	H (mm)	Ref. No.
1	418226	6500	220	3	370	185	255	144436

Marels



1

fig.	Vare nr.	P (W)	volt. (V)	HC	L (mm)	W (mm)	H (mm)	Ref. No.
1	419031	3400/3700	230/240	1	405	44	228	965.009.00

Mareno



1 2

fig.	Vare nr.	P (W)	volt. (V)	HC	L (mm)	W (mm)	H (mm)	Ref. No.
1	416812	9000	230/400	3	360	170	35	MA1037316601R
2	416813	10500	230/400	3	320	240	32	MACM032101R



3

fig.	Vare nr.	P (W)	volt. (V)	HC	L (mm)	W (mm)	H (mm)	Ref. No.
3	416814	16500	230/400	3	400	315	36	MACM032401



1

fig.	Vare nr.	P (W)	volt. (V)	HC	L (mm)	W (mm)	H (mm)	Ref. No.
1	415090	5500	230/400	3	320	200	210	MA1037039915
1	415963	7250	230/400	3	330	194	212	MA1037301615



1 2

fig.	Vare nr.	P (W)	volt. (V)	HC	L (mm)	W (mm)	H (mm)	Ref. No.
1	415962	2000	230	1	318	58	200	1037314944
1	415961	3000	230	1	325	54	206	1037313044
2	415976	2300	230	1	210	66	315	MA1750000



3 4

fig.	Vare nr.	P (W)	volt. (V)	HC	L (mm)	W (mm)	H (mm)	Ref. No.
3	415969	2400	230	1	212	74	310	MA1982700
4	415985	3000	220	1	350	55	330	MA1463900



5 6

fig.	Vare nr.	P (W)	volt. (V)	HC	L (mm)	W (mm)	H (mm)	Ref. No.
5	415990	5800	230	1	343	110	328	MA1982900
6	416810	6000	230/400	3	320	175	205	MA1037317100
6	416811	9000	230	3	320	175	205	MA1037317200



MBM-Italia

fig.	Vare nr.	P (W)	volt. (V)	HC	L (mm)	W (mm)	H (mm)	Ref. No.
1	418544	9000	230/400	3	285	205	35	180950
2	418628	9000	230/400	3	285	205	35	RIC0003794

fig.	Vare nr.	P (W)	volt. (V)	HC	L (mm)	W (mm)	H (mm)	Ref. No.
3	416070	10200	230/400	3	300	180	33	RTBF700101
4	416560	15000	230/400	3	300	290	34	RTBF800318

fig.	Vare nr.	P (W)	volt. (V)	HC	L (mm)	W (mm)	H (mm)	Ref. No.
5	418494	16000	230/400	3	336	252	31	180953

fig.	Vare nr.	P (W)	volt. (V)	HC	L (mm)	W (mm)	H (mm)	Ref. No.
1	416506	6600	230/400	3	342	127	230	RTCU600235

fig.	Vare nr.	P (W)	volt. (V)	HC	L (mm)	W (mm)	H (mm)	Ref. No.
1	416891	3000	230	1	362	65	240	180580
2	418908	9000	230	3	350	228	237	164717

MKN

fig.	Vare nr.	P (W)	volt. (V)	HC	L (mm)	W (mm)	H (mm)	Ref. No.
1	415713	2000	220	1	465	40	205	572069
2	415422	2000	230	1	300	40	240	572064

fig.	Vare nr.	P (W)	volt. (V)	HC	L (mm)	W (mm)	H (mm)	Ref. No.
3	415423	2000	230	1	320	40	215	572118
4	415710	2000	230	1	370	30	235	572076

fig.	Vare nr.	P (W)	volt. (V)	HC	L (mm)	W (mm)	H (mm)	Ref. No.
5	417533	3300	230	1	320	80	220	572121(old)
6	415728	3300	230	1	315	33	216	572124

fig.	Vare nr.	P (W)	volt. (V)	HC	L (mm)	W (mm)	H (mm)	Ref. No.
7	415746	3300	230	1	320	40	250	—
8	415769	3300	230	1	320	80	214	572121



fig.	Vare nr.	P (W)	volt. (V)	HC	L (mm)	W (mm)	H (mm)	Ref. No.
9	415779	3300	230	1	323	70	222	572128
10	415819	3300	230	1	339	68	235	572049

Modular



fig.	Vare nr.	P (W)	volt. (V)	HC	L (mm)	W (mm)	H (mm)	Ref. No.
1	415929	2500	230	1	293	40	205	66502800
1	419031	3400/3700	230/240	1	405	44	228	965.009.00

Multi



fig.	Vare nr.	P (W)	volt. (V)	HC	L (mm)	W (mm)	H (mm)	Ref. No.
1	415929	2500	230	1	293	40	205	665028

Nayati



fig.	Vare nr.	P (W)	volt. (V)	HC	L (mm)	W (mm)	H (mm)	Ref. No.
1	415742	2300	230	1	280	90	180	PD.4118C
2	418432	6000	230/400	3	275	172	161	PD411L

Offcar



fig.	Vare nr.	P (W)	volt. (V)	HC	L (mm)	W (mm)	H (mm)	Ref. No.
1	415297	6800	230/400	3	299	107	35	862033
2	416070	10200	230/400	3	300	180	33	862029

Olis



fig.	Vare nr.	P (W)	volt. (V)	HC	L (mm)	W (mm)	H (mm)	Ref. No.
1	418713	9000	230/400	3	395	135	267	BN9000482
1	418710	13000	230/400	3	385	200	270	BN9000483
2	420063	13000	230/400	3	385	200	245	BN9000481
2	419019	18000	230	3	455	243	264	BN9000519

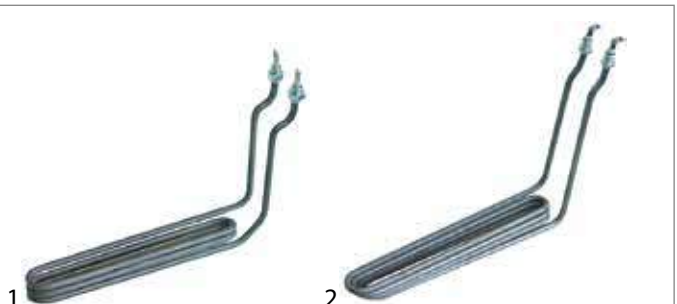

fig.	Vare nr.	P (W)	volt. (V)	HC	L (mm)	W (mm)	H (mm)	Ref. No.
1	416800	2300	230	1	340	42	210	BN8208200
2	416804	3300	230	1	331	41	260	BN9000509



fig.	Vare nr.	P (W)	volt. (V)	HC	L (mm)	W (mm)	H (mm)	Ref. No.
3	416799	5500	230	3	297	168	31	BN8217600

Palux



fig.	Vare nr.	P (W)	volt. (V)	HC	L (mm)	W (mm)	H (mm)	Ref. No.
1	416909	6000	230/400	3	300	185	22	257001
2	416910	8000	230/400	3	300	185	22	602051

1

fig.	Vare nr.	P (W)	volt. (V)	HC	L (mm)	W (mm)	H (mm)	Ref. No.
1	415444	6000	230/400	3	272	206	220	008591



1 2

fig.	Vare nr.	P (W)	volt. (V)	HC	L (mm)	W (mm)	H (mm)	Ref. No.
1	420425	5500	240	1	265	97	290	P5046921
1	420423	7000	240	1	280	87	295	P5046916
2	420424	6000	240	1	365	105	295	P5046902



1 2

fig.	Vare nr.	P (W)	volt. (V)	HC	L (mm)	W (mm)	H (mm)	Ref. No.
1	415474	1660	230	1	288	66	242	—
2	415591	2000	230	1	285	40	240	150711
2	415978	3000	230	1	288	48	243	155268



3

fig.	Vare nr.	P (W)	volt. (V)	HC	L (mm)	W (mm)	H (mm)	Ref. No.
3	420427	8500	230	3	260	90	260	PP10904



3

fig.	Vare nr.	P (W)	volt. (V)	HC	L (mm)	W (mm)	H (mm)	Ref. No.
3	415441	3000	230	1	294	150	242	—

Polaris



1

fig.	Vare nr.	P (W)	volt. (V)	HC	L (mm)	W (mm)	H (mm)	Ref. No.
1	415297	6800	230/400	3	299	107	35	BN4185326002136

Repagas



1 2

fig.	Vare nr.	P (W)	volt. (V)	HC	L (mm)	W (mm)	H (mm)	Ref. No.
1	415921	1260	230	1	320	48	220	8700024
1	415920	2800	230	1	280	160	185	8500013
2	420210	1600	230	1	283	75	200	16300008

Pitco



1 2

fig.	Vare nr.	P (W)	volt. (V)	HC	L (mm)	W (mm)	H (mm)	Ref. No.
1	420421	7000	240	3	280	158	285	B5307203-C
2	420428	8500	230	3	355	115	280	50006614

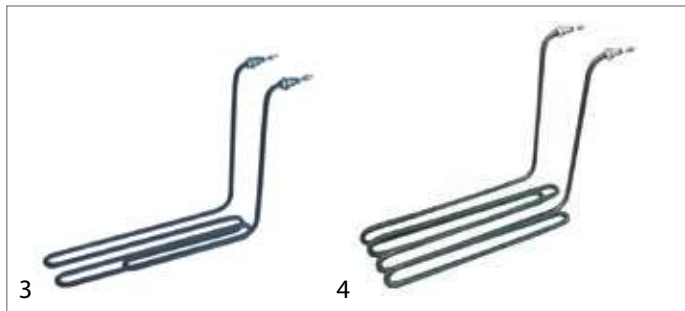

fig.	Vare nr.	P (W)	volt. (V)	HC	L (mm)	W (mm)	H (mm)	Ref. No.
3	415923	2000	230	1	315	74	250	8800027
4	415924	3000	230	1	297	86	243	1130002

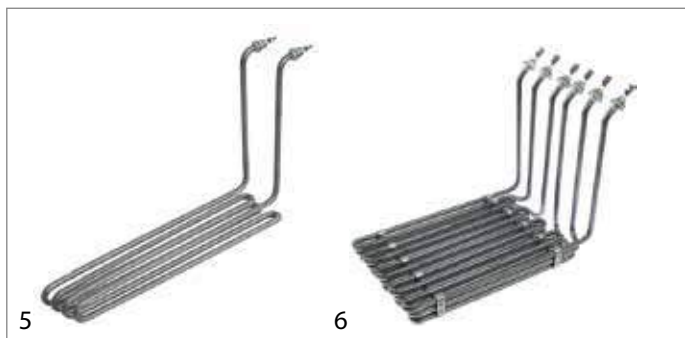

fig.	Vare nr.	P (W)	volt. (V)	HC	L (mm)	W (mm)	H (mm)	Ref. No.
5	416782	3333	230	1	395	85	245	9000007
5	416783	5500	230	1	250	60	250	1140011
6	420209	9000	230	3	310	180	235	16500005

RM-Gastro

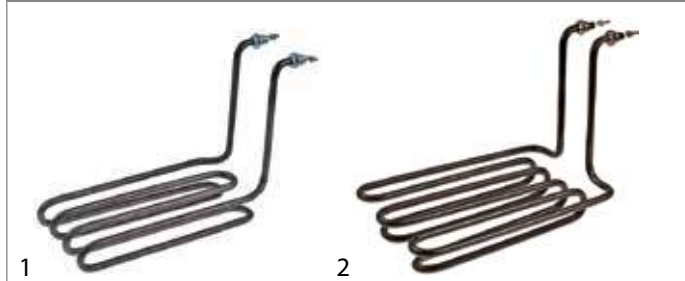

fig.	Vare nr.	P (W)	volt. (V)	HC	L (mm)	W (mm)	H (mm)	Ref. No.
1	418654	2100	230	1	270	120	200	401001000
1	418669	3000	230	1	270	110	200	401002000
1	418671	3000	230	1	300	120	215	401002520
2	418655	3000	230	1	275	175	200	401002500
2	418670	3000	230	1	310	175	220	401002510

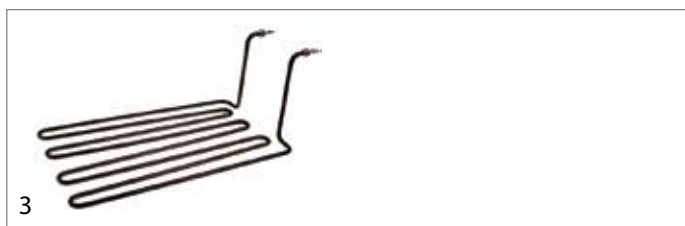

fig.	Vare nr.	P (W)	volt. (V)	HC	L (mm)	W (mm)	H (mm)	Ref. No.
3	418665	5000	230	1	473	250	190	401003000

Roka



fig.	Vare nr.	P (W)	volt. (V)	HC	L (mm)	W (mm)	H (mm)	Ref. No.
1	415792	6000	230/400	3	290	198	245	8900350

Roller Grill



fig.	Vare nr.	P (W)	volt. (V)	HC	L (mm)	W (mm)	H (mm)	Ref. No.
1	416744	2000	230	1	282	120	175	D02010
2	416745	2500	230	1	285	125	177	D02069



fig.	Vare nr.	P (W)	volt. (V)	HC	L (mm)	W (mm)	H (mm)	Ref. No.
3	418833	3600	230	1	295	180	175	D02070



fig.	Vare nr.	P (W)	volt. (V)	HC	L (mm)	W (mm)	H (mm)	Ref. No.
1	416741	4000	230	1	465	82	280	D02028
1	416742	6000	230	1	460	86	290	D02099



Rosinox

fig.	Vare nr.	P (W)	volt. (V)	HC	L (mm)	W (mm)	H (mm)	Ref. No.
1	415297	6800	230/400	3	299	107	35	RX94806916
2	416070	10200	230/400	3	300	180	33	RX94805397

fig.	Vare nr.	P (W)	volt. (V)	HC	L (mm)	W (mm)	H (mm)	Ref. No.
3	416813	10500	230/400	3	320	240	32	RX94812639

fig.	Vare nr.	P (W)	volt. (V)	HC	L (mm)	W (mm)	H (mm)	Ref. No.
1	415257	6000	230/400	3	300	182	252	RX94812636

Saro

fig.	Vare nr.	P (W)	volt. (V)	HC	L (mm)	W (mm)	H (mm)	Ref. No.
1	418643	3200	230	1	290	185	165	172-5016

Silko

fig.	Vare nr.	P (W)	volt. (V)	HC	L (mm)	W (mm)	H (mm)	Ref. No.
1	415297	6800	230/400	3	299	107	35	SIR0108058
2	416812	9000	230/400	3	360	170	35	MA1037316601

fig.	Vare nr.	P (W)	volt. (V)	HC	L (mm)	W (mm)	H (mm)	Ref. No.
3	416070	10200	230/400	3	300	180	33	SIR0108057
4	416814	16500	230/400	3	400	315	36	SIR0105151

fig.	Vare nr.	P (W)	volt. (V)	HC	L (mm)	W (mm)	H (mm)	Ref. No.
1	415257	6000	230/400	3	300	182	252	SIR0109025

fig.	Vare nr.	P (W)	volt. (V)	HC	L (mm)	W (mm)	H (mm)	Ref. No.
1	416054	1700	230	1	320	70	215	SIR0109022
2	416055	3000	230	1	335	65	223	SIR0109021

Solymac

fig.	Vare nr.	P (W)	volt. (V)	HC	L (mm)	W (mm)	H (mm)	Ref. No.
1	420184	3500	230	1	294	170	208	P59



fig.	Vare nr.	P (W)	volt. (V)	HC	L (mm)	W (mm)	H (mm)	Ref. No.
1	420186	7000	230	3	393	245	210	P40
1	420185	12000	230	3	415	237	213	P41

SSG



fig.	Vare nr.	P (W)	volt. (V)	HC	L (mm)	W (mm)	H (mm)	Ref. No.
1	415753	6000	400	3	324	195	265	—

Star10



fig.	Vare nr.	P (W)	volt. (V)	HC	L (mm)	W (mm)	H (mm)	Ref. No.
1	418269	7500	230/400	3	310	180	260	071028

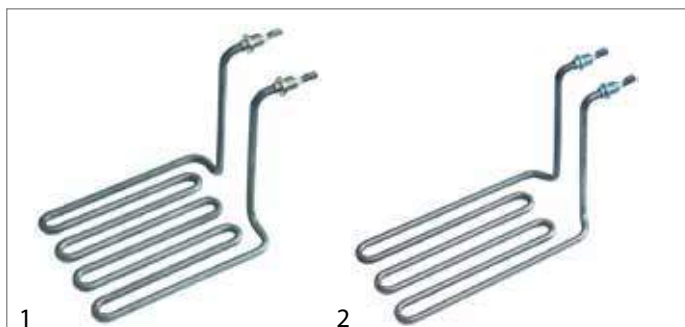

fig.	Vare nr.	P (W)	volt. (V)	HC	L (mm)	W (mm)	H (mm)	Ref. No.
1	416168	2500	230	1	222	154	175	071077
2	416167	2500	230	1	275	157	185	071055.1

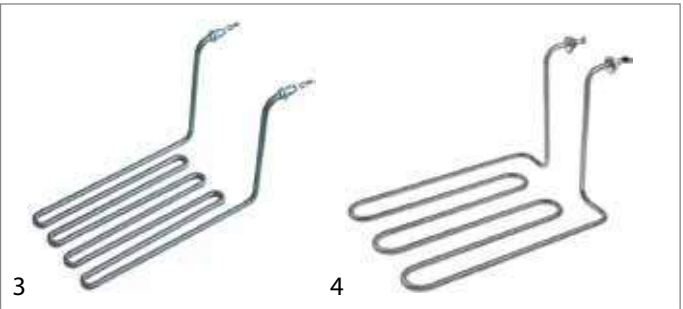

fig.	Vare nr.	P (W)	volt. (V)	HC	L (mm)	W (mm)	H (mm)	Ref. No.
3	416169	3000	230	1	290	160	185	071052
4	417567	3000	230	1	290	205	195	071001



fig.	Vare nr.	P (W)	volt. (V)	HC	L (mm)	W (mm)	H (mm)	Ref. No.
5	416172	3000	230	1	300	80	255	071005

Tecnoinox



fig.	Vare nr.	P (W)	volt. (V)	HC	L (mm)	W (mm)	H (mm)	Ref. No.
1	415291	2000	230	1	250	45	190	RC00282000
2	415283	3000	230	1	290	78	185	RC00054000



fig.	Vare nr.	P (W)	volt. (V)	HC	L (mm)	W (mm)	H (mm)	Ref. No.
3	416660	3600	230	1	280	68	246	RC01276000

Thielmann

fig.	Vare nr.	P (W)	volt. (V)	HC	L (mm)	W (mm)	H (mm)	Ref. No.
1	415753	6000	400	3	324	195	265	—
2	418263	7200	230/400	3	360	150	220	144187

fig.	Vare nr.	P (W)	volt. (V)	HC	L (mm)	W (mm)	H (mm)	Ref. No.
1	418358	7200	400	3	285	150	255	6291-1SA
1	418340	11000	400	3	285	150	255	6302-3SA

Ubert

fig.	Vare nr.	P (W)	volt. (V)	HC	L (mm)	W (mm)	H (mm)	Ref. No.
1	415566	2000	230	1	325	42	275	343104

VEGA

fig.	Vare nr.	P (W)	volt. (V)	HC	L (mm)	W (mm)	H (mm)	Ref. No.
1	416172	3000	230	1	300	80	255	93097

Valentine

fig.	Vare nr.	P (W)	volt. (V)	HC	L (mm)	W (mm)	H (mm)	Ref. No.
1	418357	2333	230	1	268	94	190	5185-01
1	418356	2500	400	1	268	84	190	5184-01
2	418354	3600	230	1	268	138	190	5181-01
2	418355	3600	400	1	268	145	190	5182-01

Wamsler

fig.	Vare nr.	P (W)	volt. (V)	HC	L (mm)	W (mm)	H (mm)	Ref. No.
1	418630	6900	400	3	375	170	255	00011110092

Zanussi

fig.	Vare nr.	P (W)	volt. (V)	HC	L (mm)	W (mm)	H (mm)	Ref. No.
1	420124	2900	230	1	233	77	245	004628
2	416995	2900	230	1	270	50	246	0A5565
2	416994	2900	230	1	310	60	195	005964



fig.	Vare nr.	P (W)	volt. (V)	HC	L (mm)	W (mm)	H (mm)	Ref. No.
3	415274	3000	230	1	400	70	270	058615
4	415377	5500	230	1	320	86	248	059563
4	418002	5500	400	1	320	86	248	006571



fig.	Vare nr.	P (W)	volt. (V)	HC	L (mm)	W (mm)	H (mm)	Ref. No.
1	415291	2000	230	1	250	45	190	004926

heating elements for griddles

Ambach

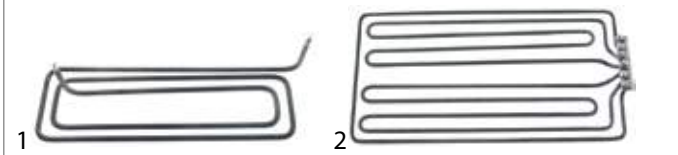

fig.	Vare nr.	P (W)	volt. (V)	L (mm)	W (mm)	H (mm)	Ref. No.
1	416954	2000	230	480	154	92	5060814403
2	415869	5000	230	506	265	50	5060803506



fig.	Vare nr.	P (W)	volt. (V)	L (mm)	W (mm)	H (mm)	Ref. No.
3	416951	6000	230	540	315	50	5060803509

Ambassade



fig.	Vare nr.	P (W)	volt. (V)	L (mm)	W (mm)	H (mm)	Ref. No.
1	418934	1100	230	327	96.5	52	652208
1	418489	1100	230	467	95	52	65211011

Angelo-Po

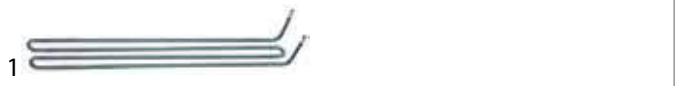

fig.	Vare nr.	P (W)	volt. (V)	L (mm)	W (mm)	H (mm)	Ref. No.
1	416678	1700	400	445	75	83	32G1040
1	415179	1750	230	445	82	50	32G1262
1	416679	2200	400	572	81	85	32G1870

Anitec



fig.	Vare nr.	P (W)	volt. (V)	L (mm)	W (mm)	H (mm)	Ref. No.
1	415703	1000	230	333	80	64	071044
1	416161	1000	230	430	95	36	071027

Arris/Grillvapor



fig.	Vare nr.	P (W)	volt. (V)	L (mm)	W (mm)	H (mm)	Ref. No.
1	419030	440	115	580	23	-	90.046/2

Baron

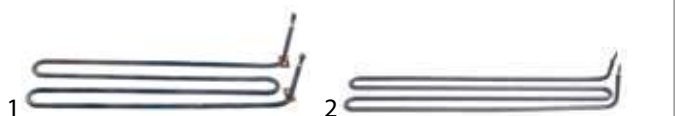

fig.	Vare nr.	P (W)	volt. (V)	L (mm)	W (mm)	H (mm)	Ref. No.
1	418027	1250	230	407	88	20	BN41826620070
2	415076	1300	230	490	78	70	MA1037300713

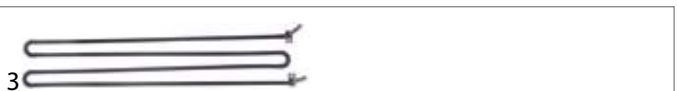

fig.	Vare nr.	P (W)	volt. (V)	L (mm)	W (mm)	H (mm)	Ref. No.
3	418444	2666	230	555	100	23	41826620061

Bartscher



fig.	Vare nr.	P (W)	volt. (V)	L (mm)	W (mm)	H (mm)	Ref. No.
1	418934	1100	230	327	96.5	52	021786
1	418489	1100	230	467	95	52	065211011

Bertos



fig.	Vare nr.	P (W)	volt. (V)	L (mm)	W (mm)	H (mm)	Ref. No.
1	415651	1500	230	425	72	53	22039300



Bonnet



fig.	Vare nr.	P (W)	volt. (V)	L (mm)	W (mm)	H (mm)	Ref. No.
1	418922	1800	220	523	57	81	310128

Bourgeois



fig.	Vare nr.	P (W)	volt. (V)	L (mm)	W (mm)	H (mm)	Ref. No.
1	418451	1666	230	435	60	74	RC3015

Capic

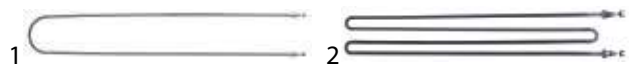

fig.	Vare nr.	P (W)	volt. (V)	L (mm)	W (mm)	H (mm)	Ref. No.
1	418960	1000	230	750	110	-	E150587
2	418845	1500	230	480	70	-	E150840



fig.	Vare nr.	P (W)	volt. (V)	L (mm)	W (mm)	H (mm)	Ref. No.
3	418937	3000	230	430	320	58	E151138

Capito



fig.	Vare nr.	P (W)	volt. (V)	L (mm)	W (mm)	H (mm)	Ref. No.
1	418268	2000	230	396	123	38	63853

Charvet



fig.	Vare nr.	P (W)	volt. (V)	L (mm)	W (mm)	H (mm)	Ref. No.
1	420001	1000	230	405	60	-	03483A

Cookmax

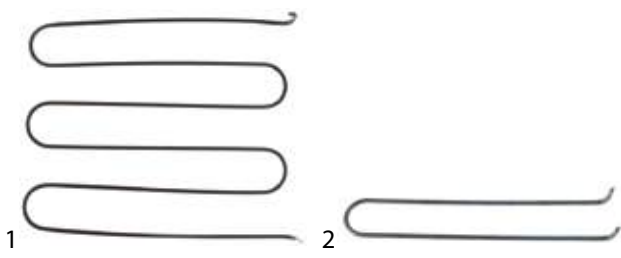

fig.	Vare nr.	P (W)	volt. (V)	L (mm)	W (mm)	H (mm)	Ref. No.
1	418644	450	230	440	350	45	IV5253500
2	418498	1000	230	472	76	38	PD411K

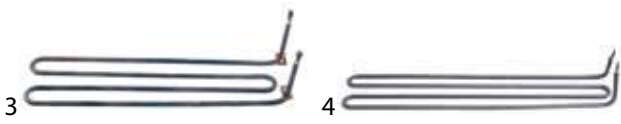

fig.	Vare nr.	P (W)	volt. (V)	L (mm)	W (mm)	H (mm)	Ref. No.
3	418027	1250	230	407	88	20	41826620070
4	415076	1300	230	490	78	70	1037300713

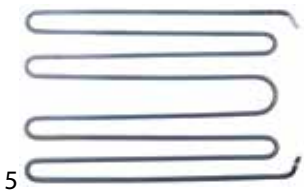

fig.	Vare nr.	P (W)	volt. (V)	L (mm)	W (mm)	H (mm)	Ref. No.
5	419009	3000	230	430	270	35	401025000

EGO

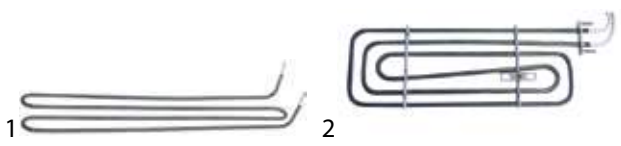

fig.	Vare nr.	P (W)	volt. (V)	L (mm)	W (mm)	H (mm)	Ref. No.
1	418934	1100	230	327	96.5	52	24.13545.023
2	415325	1200	230	282	100	-	24.33119.000



fig.	Vare nr.	P (W)	volt. (V)	L (mm)	W (mm)	H (mm)	Ref. No.
3	415425	1250	220	470	64	60	20.30162.000
4	415324	1600	230	574	68	-	24.33118.000

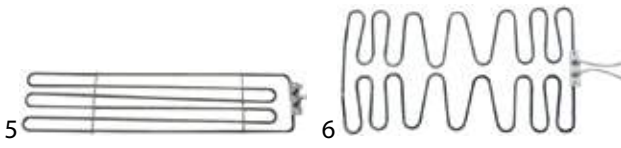

fig.	Vare nr.	P (W)	volt. (V)	L (mm)	W (mm)	H (mm)	Ref. No.
5	415593	2565	230	554	125	30	20.21759.000
5	415594	2565	400	556	126	33	20.21759.060
6	415363	3000	230	450	242	20	20.19326.000



EKU

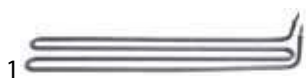

fig.	Vare nr.	P (W)	volt. (V)	L (mm)	W (mm)	H (mm)	Ref. No.
1	415076	1300	230	490	78	70	373.007.0 1-W-237

Electrolux

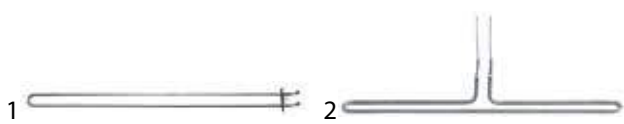

fig.	Vare nr.	P (W)	volt. (V)	L (mm)	W (mm)	H (mm)	Ref. No.
1	415479	750	230	471	30	-	0H6183
2	415480	1000	220	457	40	70	0H6182
2	415482	1100	400	538	45	67	0H6155



fig.	Vare nr.	P (W)	volt. (V)	L (mm)	W (mm)	H (mm)	Ref. No.
3	415079	1250	230	473	52	43	053614
4	416985	1250	230	482	54	55	004649

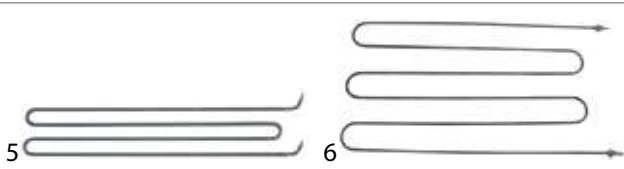

fig.	Vare nr.	P (W)	volt. (V)	L (mm)	W (mm)	H (mm)	Ref. No.
5	415290	1300	230	473	80	55	004918
5	415075	2000	220	573	80	70	0K9222
5	415382	2000	230	595	41	40	055998
5	416987	2500	400	567	90	91	006681
6	415624	2400	400	605	380	-	0K4984

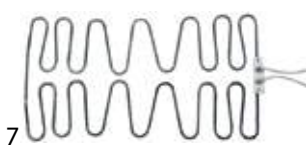

fig.	Vare nr.	P (W)	volt. (V)	L (mm)	W (mm)	H (mm)	Ref. No.
7	415363	3000	230	450	242	20	0K9904

Emmepi



fig.	Vare nr.	P (W)	volt. (V)	L (mm)	W (mm)	H (mm)	Ref. No.
1	416062	1000	230	220	103	32	C10199
1	416075	1200	230	295	105	32	C00650

Fagor



fig.	Vare nr.	P (W)	volt. (V)	L (mm)	W (mm)	H (mm)	Ref. No.
1	416602	1500	230	517	87	71	12024616
2	416633	2000	230	585	100	100	12024626

Franke



fig.	Vare nr.	P (W)	volt. (V)	L (mm)	W (mm)	H (mm)	Ref. No.
1	418437	3500	380	478	250	70	178996
2	418406	3500	400	455	287	77	178857

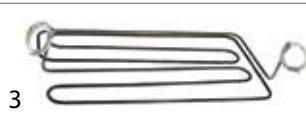

fig.	Vare nr.	P (W)	volt. (V)	L (mm)	W (mm)	H (mm)	Ref. No.
3	418436	3500	400	480	250	70	BK178995

GGX

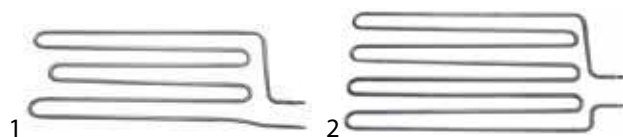

fig.	Vare nr.	P (W)	volt. (V)	L (mm)	W (mm)	H (mm)	Ref. No.
1	415478	3000	230	475	176	-	345981.532
2	415468	4500	400	520	239	-	340640.532

Gico



fig.	Vare nr.	P (W)	volt. (V)	L (mm)	W (mm)	H (mm)	Ref. No.
1	416096	1370	240	430	100	60	270200662
1	416100	2020	240	550	100	60	290200112

GIGA



fig.	Vare nr.	P (W)	volt. (V)	L (mm)	W (mm)	H (mm)	Ref. No.
1	415651	1500	230	425	72	53	X45700
2	416046	2350/2560	220/240	590	77	80	Y10400



Haka

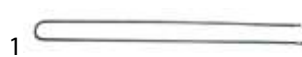

fig.	Vare nr.	P (W)	volt. (V)	L (mm)	W (mm)	H (mm)	Ref. No.
1	415749	1500	230	735	55	-	9011

Herzog&Langen

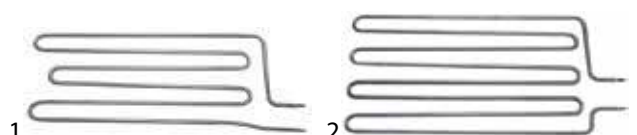

fig.	Vare nr.	P (W)	volt. (V)	L (mm)	W (mm)	H (mm)	Ref. No.
1	415478	3000	230	475	176	-	345981.532
2	415468	4500	400	520	239	-	340640.532

Juno

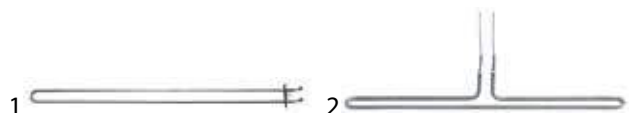

fig.	Vare nr.	P (W)	volt. (V)	L (mm)	W (mm)	H (mm)	Ref. No.
1	415479	750	230	471	30	-	0H6183
2	415480	1000	220	457	40	70	0H6182
2	415482	1100	400	538	45	67	0H6155



fig.	Vare nr.	P (W)	volt. (V)	L (mm)	W (mm)	H (mm)	Ref. No.
3	415079	1250	230	473	52	43	053614

King

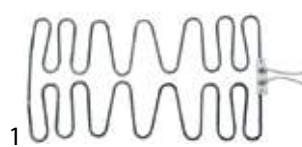

fig.	Vare nr.	P (W)	volt. (V)	L (mm)	W (mm)	H (mm)	Ref. No.
1	415363	3000	230	450	242	20	0K9904

Krefftt

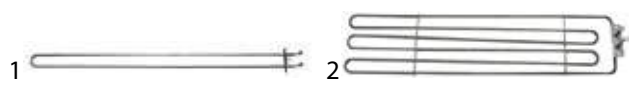

fig.	Vare nr.	P (W)	volt. (V)	L (mm)	W (mm)	H (mm)	Ref. No.
1	415479	750	230	471	30	-	01-214338
2	415593	2565	230	554	125	30	49-182330
2	415594	2565	400	556	126	33	49-182329

KSF



fig.	Vare nr.	P (W)	volt. (V)	L (mm)	W (mm)	H (mm)	Ref. No.
1	416491	1500	220	406	70	-	4.013.03.05

Küppersbusch

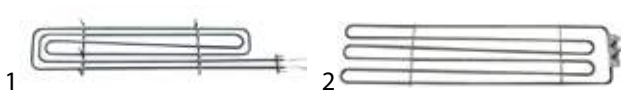

fig.	Vare nr.	P (W)	volt. (V)	L (mm)	W (mm)	H (mm)	Ref. No.
1	415824	2000	400	533	92	-	182356
2	415593	2565	230	554	125	30	160104
2	415594	2565	400	556	126	33	182329

Lotus

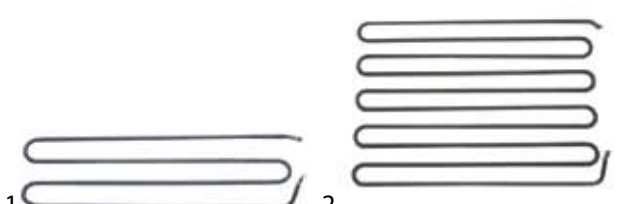

fig.	Vare nr.	P (W)	volt. (V)	L (mm)	W (mm)	H (mm)	Ref. No.
1	415703	1000	230	333	80	64	537005100
1	415367	1500	230	425	90	70	537005200
2	415702	2400	230	342	227	53	537004100

Mareno

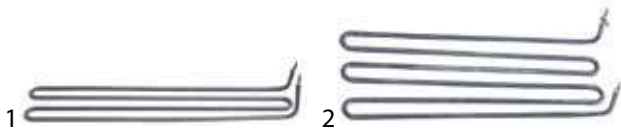

fig.	Vare nr.	P (W)	volt. (V)	L (mm)	W (mm)	H (mm)	Ref. No.
1	415076	1300	230	490	78	70	MA1037300713
1	416175	1600	230	417	87	90	MACM164800
1	415975	1800	240	488	84	63	MA1730000
1	416694	2200	230	570	110	90	MACM164900
2	416180	2200	230	420	130	92	MACM165100

MBM-Italia



fig.	Vare nr.	P (W)	volt. (V)	L (mm)	W (mm)	H (mm)	Ref. No.
1	416544	1250	240	416	70	65	RTCU600183
1	416547	1350	230	450	82	64	RTCU700278
1	416555	2000	240	570	92	65	RTBE800038



MKN



fig.	Vare nr.	P (W)	volt. (V)	L (mm)	W (mm)	H (mm)	Ref. No.
1	415425	1250	220	470	64	60	574099
2	415446	1250	230	450	65	60	203550

Modular



fig.	Vare nr.	P (W)	volt. (V)	L (mm)	W (mm)	H (mm)	Ref. No.
1	416534	1000	230	422	70	66	66505700
2	415928	1800	240	470	90	65	66500200

Multi



fig.	Vare nr.	P (W)	volt. (V)	L (mm)	W (mm)	H (mm)	Ref. No.
1	415928	1800	240	470	90	65	665002
2	415933	2580	240	530	130	65	965008

Nayati



fig.	Vare nr.	P (W)	volt. (V)	L (mm)	W (mm)	H (mm)	Ref. No.
1	418498	1000	230	472	76	38	PD411K
1	418062	1000	400	470	78	34	SS2027
2	416668	1600	230	366	65	62	PD.4115A

Nisbets

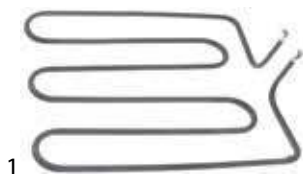

fig.	Vare nr.	P (W)	volt. (V)	L (mm)	W (mm)	H (mm)	Ref. No.
1	419182	3000	240	340	300	65	N497

North

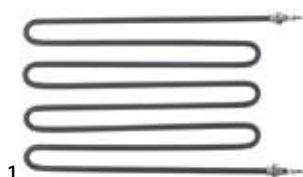

fig.	Vare nr.	P (W)	volt. (V)	L (mm)	W (mm)	H (mm)	Ref. No.
1	420294	2500	230	340	208	-	EWG15

Offcar



fig.	Vare nr.	P (W)	volt. (V)	L (mm)	W (mm)	H (mm)	Ref. No.
1	416668	1600	230	366	65	62	843627

Olis



fig.	Vare nr.	P (W)	volt. (V)	L (mm)	W (mm)	H (mm)	Ref. No.
1	416790	900	220	435	42.5	50	BN6A037250
2	416789	1300	230	475	83	66	BN8217700
2	416791	1700	230	440	90	64	BN6A044706
2	416792	2660	230	578	88	63	BN6A037450



fig.	Vare nr.	P (W)	volt. (V)	L (mm)	W (mm)	H (mm)	Ref. No.
3	418444	2666	230	555	100	23	BN826620061

Palux

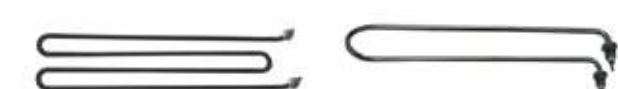

fig.	Vare nr.	P (W)	volt. (V)	L (mm)	W (mm)	H (mm)	Ref. No.
1	415435	1500	220	425	100	28	083577
2	415434	1500	230	342	79	29	056928



fig.	Vare nr.	P (W)	volt. (V)	L (mm)	W (mm)	H (mm)	Ref. No.
3	415442	1500	230	400	50	54	—

Repagas



fig.	Vare nr.	P (W)	volt. (V)	L (mm)	W (mm)	H (mm)	Ref. No.
1	420218	1000	230	345	56	55	32100002



RM-Gastro

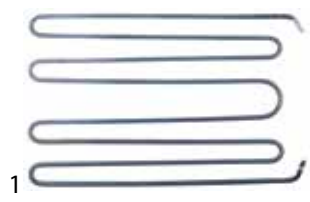

fig.	Vare nr.	P (W)	volt. (V)	L (mm)	W (mm)	H (mm)	Ref. No.
1	419009	3000	230	430	270	35	401025000

Roka

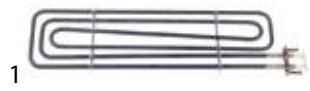

fig.	Vare nr.	P (W)	volt. (V)	L (mm)	W (mm)	H (mm)	Ref. No.
1	418235	1600	230	385	100	-	8900322

Roller Grill

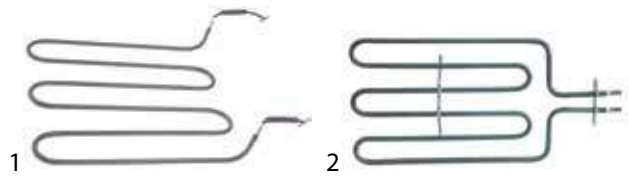

fig.	Vare nr.	P (W)	volt. (V)	L (mm)	W (mm)	H (mm)	Ref. No.
1	419177	1750	230	255	240	60	D02169
2	416772	2500	230	350	182	-	D02011

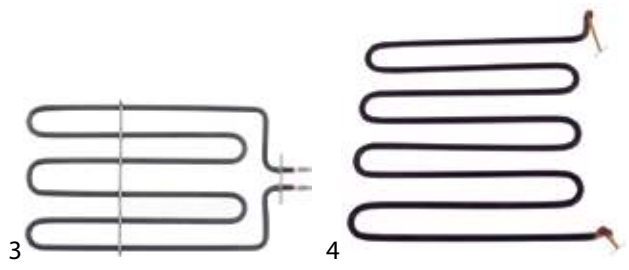

fig.	Vare nr.	P (W)	volt. (V)	L (mm)	W (mm)	H (mm)	Ref. No.
3	420456	2800	230	338	190	25	D02160
4	418622	3000	230	277	245	55	D02105

Rosinox



fig.	Vare nr.	P (W)	volt. (V)	L (mm)	W (mm)	H (mm)	Ref. No.
1	420406	1000	230-240	69	268	85	RX94035706
2	415651	1500	230	425	72	53	RX94805678
2	415296	1580	230	460	65	71	RX94814020

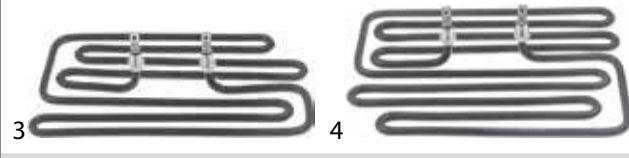

fig.	Vare nr.	P (W)	volt. (V)	L (mm)	W (mm)	H (mm)	Ref. No.
3	419124	2000	230	270	150	40	RX94001872
4	419125	2000	230	270	190	40	RX94001807



fig.	Vare nr.	P (W)	volt. (V)	L (mm)	W (mm)	H (mm)	Ref. No.
5	420246	2400	230	425	115	40	RX94001930

Salvis



fig.	Vare nr.	P (W)	volt. (V)	L (mm)	W (mm)	H (mm)	Ref. No.
1	418437	3500	380	478	250	70	1G870136
2	418406	3500	400	455	287	77	1G870071



fig.	Vare nr.	P (W)	volt. (V)	L (mm)	W (mm)	H (mm)	Ref. No.
3	418436	3500	400	480	250	70	BK178995

Silko



fig.	Vare nr.	P (W)	volt. (V)	L (mm)	W (mm)	H (mm)	Ref. No.
1	415076	1300	230	490	78	70	MA1037300713
2	415369	1350	230	435	46	-	SIR0101529



fig.	Vare nr.	P (W)	volt. (V)	L (mm)	W (mm)	H (mm)	Ref. No.
3	415651	1500	230	425	72	53	SIR0109041
3	415296	1580	230	460	65	71	SIR0101563
4	420103	1800	230	460	90	78	CR0689240



fig.	Vare nr.	P (W)	volt. (V)	L (mm)	W (mm)	H (mm)	Ref. No.
5	420415	2600	230	480	90	42	CR0937830



Sirman

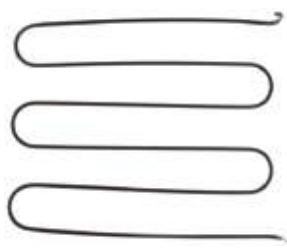

fig.	Vare nr.	P (W)	volt. (V)	L (mm)	W (mm)	H (mm)	Ref. No.
1	418644	450	230	440	350	45	IV5253500

Solymac



fig.	Vare nr.	P (W)	volt. (V)	L (mm)	W (mm)	H (mm)	Ref. No.
1	418451	1666	230	435	60	74	P37

SSG

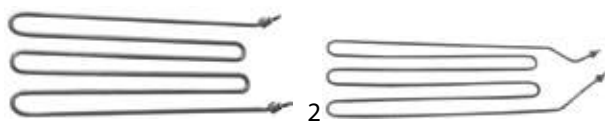

fig.	Vare nr.	P (W)	volt. (V)	L (mm)	W (mm)	H (mm)	Ref. No.
1	415759	2000	230	455	153	20	—
2	415733	2500	220	484	150	85	—

Star10



fig.	Vare nr.	P (W)	volt. (V)	L (mm)	W (mm)	H (mm)	Ref. No.
1	415703	1000	230	333	80	64	071044
1	416161	1000	230	430	95	36	071027
1	416046	2350/2560	220/240	590	77	80	Y10400
2	415651	1500	230	425	72	53	X45700

Tecnoinox



fig.	Vare nr.	P (W)	volt. (V)	L (mm)	W (mm)	H (mm)	Ref. No.
1	415290	1300	230	473	80	55	RC00286000

Therma

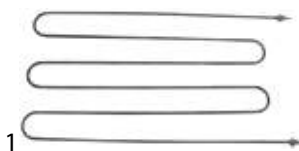

fig.	Vare nr.	P (W)	volt. (V)	L (mm)	W (mm)	H (mm)	Ref. No.
1	415624	2400	400	605	380	-	0K4984

Thielmann

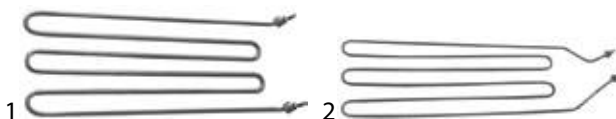

fig.	Vare nr.	P (W)	volt. (V)	L (mm)	W (mm)	H (mm)	Ref. No.
1	415759	2000	230	455	153	20	—
2	415733	2500	220	484	150	85	—

3

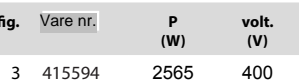

fig.	Vare nr.	P (W)	volt. (V)	L (mm)	W (mm)	H (mm)	Ref. No.
3	415594	2565	400	556	126	33	143648

Ubert

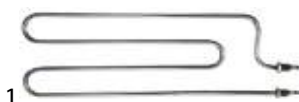

fig.	Vare nr.	P (W)	volt. (V)	L (mm)	W (mm)	H (mm)	Ref. No.
1	415561	2000	230	422	163	-	343103

VEGA

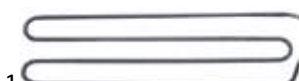

fig.	Vare nr.	P (W)	volt. (V)	L (mm)	W (mm)	H (mm)	Ref. No.
1	416161	1000	230	430	95	36	92023

Zanussi



fig.	Vare nr.	P (W)	volt. (V)	L (mm)	W (mm)	H (mm)	Ref. No.
1	415079	1250	230	473	52	43	053614
2	416985	1250	230	482	54	55	004649

3

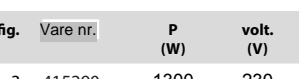

fig.	Vare nr.	P (W)	volt. (V)	L (mm)	W (mm)	H (mm)	Ref. No.
3	415290	1300	230	473	80	55	004918
3	415075	2000	220	573	80	70	0K9222
3	415382	2000	230	595	41	40	055998
3	416987	2500	400	567	90	91	006681



heating elements for large hobs

Ambach

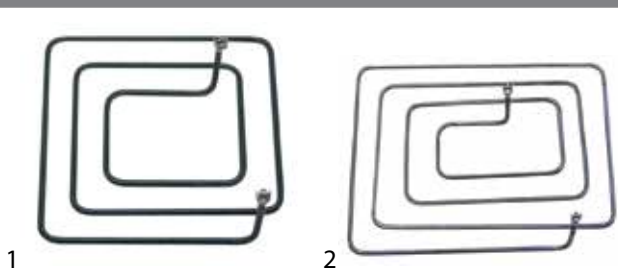

fig.	Vare nr.	P (W)	volt. (V)	L (mm)	W (mm)	H (mm)	Ref. No.
1	415866	1350	400	225	277	80	5060808463
1	415862	1350	400	228	218	82	5060808461
2	415867	1650	400	255	330	72	5060808464

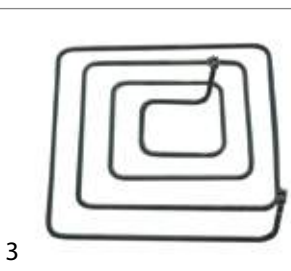

fig.	Vare nr.	P (W)	volt. (V)	L (mm)	W (mm)	H (mm)	Ref. No.
3	415863	1650	400	260	245	100	5060808462

EGO

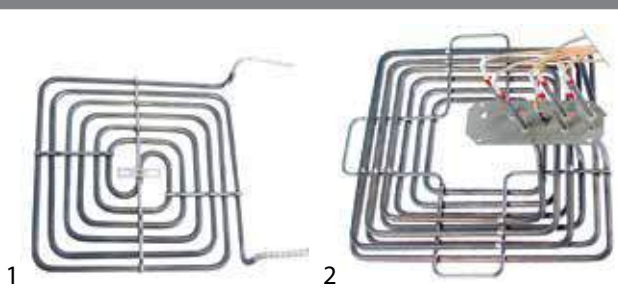

fig.	Vare nr.	P (W)	volt. (V)	L (mm)	W (mm)	H (mm)	Ref. No.
1	415321	2000	230	205	205	37	24.33115.010
2	418692	3860	400	275	260	47	20.29024.000

Electrolux

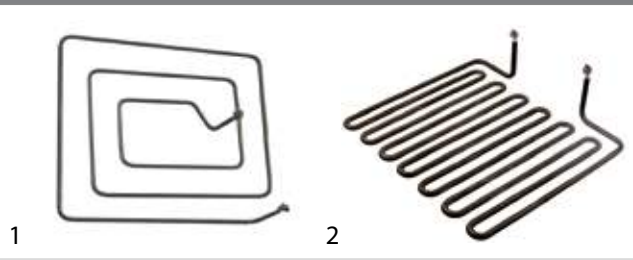

fig.	Vare nr.	P (W)	volt. (V)	L (mm)	W (mm)	H (mm)	Ref. No.
1	415577	1160	400	295	245	80	0K4815
1	420293	1160	440	295	250	95	0K4853
1	415576	1335	400	320	275	76	0K4814
1	420292	1335	440	325	275	95	0K4854
1	415575	1505	400	360	295	88	0K4813
1	420291	1505	440	350	300	95	0K4855
2	418701	4000	400	300	330	80	0G2883

Lohberger

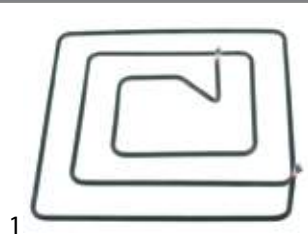

fig.	Vare nr.	P (W)	volt. (V)	L (mm)	W (mm)	H (mm)	Ref. No.
1	418704	1160	400	255	240	75	—
1	418705	1335	400	270	270	75	—
1	418706	1505	400	300	300	75	—

MKN



fig.	Vare nr.	P (W)	volt. (V)	L (mm)	W (mm)	H (mm)	Ref. No.
1	418255	600	80	332	54	54	574114

Palux

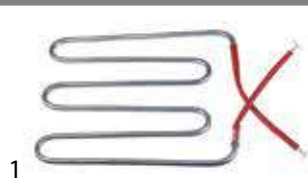

fig.	Vare nr.	P (W)	volt. (V)	L (mm)	W (mm)	H (mm)	Ref. No.
1	416894	3500	230	265	260	98	602523



Therma

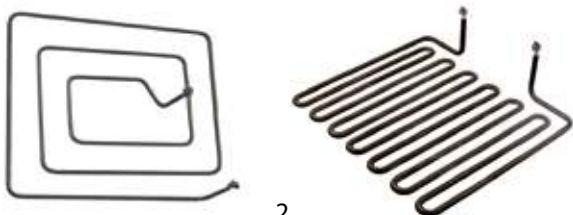

fig.	Vare nr.	P (W)	volt. (V)	L (mm)	W (mm)	H (mm)	Ref. No.
1	415576	1335	400	320	275	76	0K4814
1	420291	1505	440	350	300	95	0K4855
2	418701	4000	400	300	330	80	0G2883

North



fig.	Vare nr.	P (W)	volt. (V)	L (mm)	W (mm)	H (mm)	TS	connection	Ref. No.
1	415362	1500	230	350	95	65	-	F6.3	ELE-N8

Potis



fig.	Vare nr.	P (W)	volt. (V)	L (mm)	W (mm)	H (mm)	TS	connection	Ref. No.
1	415562	1300	230	270	92	80	M14x1.5	M4	PT0094
1	415563	1500	230	265	93	80	M14x1.5	M4	PT0095

Wamsler



fig.	Vare nr.	P (W)	volt. (V)	L (mm)	W (mm)	H (mm)	Ref. No.
1	418692	3860	400	275	260	47	00733355100

heating elements for gyros grills

Anitec



fig.	Vare nr.	P (W)	volt. (V)	L (mm)	W (mm)	H (mm)	TS	connection	Ref. No.
1	416164	1500	230	343	74	53	-	F6.3	071085

Cookmax



fig.	Vare nr.	P (W)	volt. (V)	L (mm)	W (mm)	H (mm)	TS	connection	Ref. No.
1	415562	1300	230	270	92	80	M14x1.5	M4	—
1	415563	1500	230	265	93	80	M14x1.5	M4	PT0095

EGO



fig.	Vare nr.	P (W)	volt. (V)	L (mm)	W (mm)	H (mm)	TS	connection	Ref. No.
1	415562	1300	230	270	92	80	M14x1.5	M4	20.40827.030
1	415563	1500	230	265	93	80	M14x1.5	M4	20.40827.020

Roller Grill

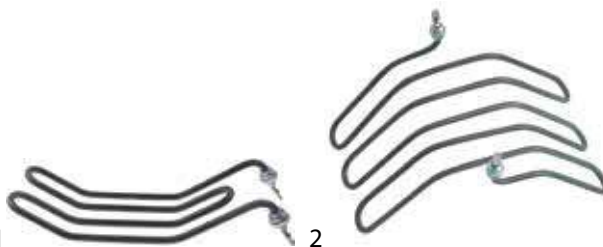

fig.	Vare nr.	P (W)	volt. (V)	L (mm)	W (mm)	H (mm)	TS	connection	Ref. No.
1	420086	1450	230	300	100	57	M14x1.5	M4	D02154
2	416704	2500	240	280	190	130	M12x1.25	M4	D02075

Star10



fig.	Vare nr.	P (W)	volt. (V)	L (mm)	W (mm)	H (mm)	TS	connection	Ref. No.
1	416164	1500	230	343	74	53	-	F6.3	071085

heating elements for chicken rotisseries

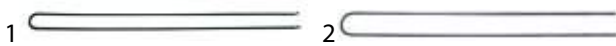

fig.	Vare nr.	P (W)	volt. (V)	TS	L (mm)	W (mm)	suitable for	Ref. No.
1	415532	1000	230		700	64	Eloma Palux	EL0103691 103691
1	415531	1000	230		725	50	Eloma Palux	EL0530905 103640
1	415536	1100	220		760	44	Wiesheu-Wiwa	35126
1	415533	1100	230		727	50	Eloma Palux	EL0532177 101575
2	415534	1000	230		795	50	Wiesheu-Wiwa WIWA	35100 422005
2	415535	1500	230		648	57	Wiesheu-Wiwa WIWA	35089 422004





fig.	Vare nr.	P (W)	volt. (V)	TS	L (mm)	W (mm)	suitable for	Ref. No.
3	415529	1000	230		917	90	Wiesheu-Wiwa	35157
4	416856	1100	230	M4	864	35	Tecno MCM	030137E

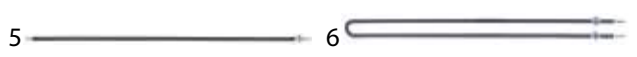

fig.	Vare nr.	P (W)	volt. (V)	TS	L (mm)	W (mm)	suitable for	Ref. No.
5	420457	1400	230		685	10.5	Roller Grill	D02152
6	419037	1400	230	1/4"	525	40	CB	07030070
6	418423	1450	230	1/4"	675	37	CB	07030563
6	416705	2500	230	M16x1.5	557	53	Roller Grill	D02074



fig.	Vare nr.	P (W)	volt. (V)	TS	L (mm)	W (mm)	suitable for	Ref. No.
7	418348	1500	230	M6x1	810	-	Chergui	03EFBL0030, RBL810R
8	416657	1500	230	M14x1.25	535	49	Tecnoinox	RC00243000

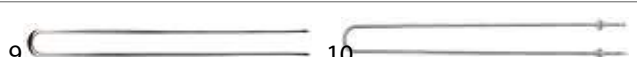

fig.	Vare nr.	P (W)	volt. (V)	TS	L (mm)	W (mm)	suitable for	Ref. No.
9	415530	2000	230		940	43	Wiesheu-Wiwa	35158
10	419206	2400	230	3/8"	738	83	Universo	A0352B



fig.	Vare nr.	P (W)	volt. (V)	TS	L (mm)	W (mm)	suitable for	Ref. No.
11	418843	3000	230	M14	705	175	Roller Grill	D02016

heating elements for hot counters

CB



fig.	Vare nr.	P (W)	volt. (V)	L (mm)	W (mm)	tube ø (mm)	Ref. No.
1	418414	1600	230	220	220	6.3	07030021

CF-Cenedese



fig.	Vare nr.	P (W)	volt. (V)	L (mm)	W (mm)	tube ø (mm)	Ref. No.
1	415699	400	230	298	138	6.3	63.7.1090

Coldmaster



fig.	Vare nr.	P (W)	volt. (V)	L (mm)	W (mm)	tube ø (mm)	Ref. No.
1	418015	1600	220	227	313	6.3	3914801

Cookmax

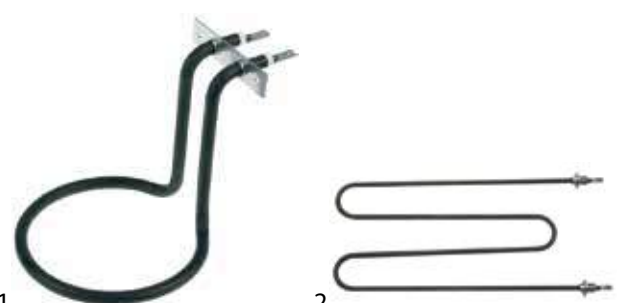

fig.	Vare nr.	P (W)	volt. (V)	L (mm)	W (mm)	tube ø (mm)	Ref. No.
1	418720	350	220	133	116	8	X02.05.619.00
2	415699	400	230	298	138	6.3	401021200
2	418666	700	230	630	160	6.3	401021701

EGO

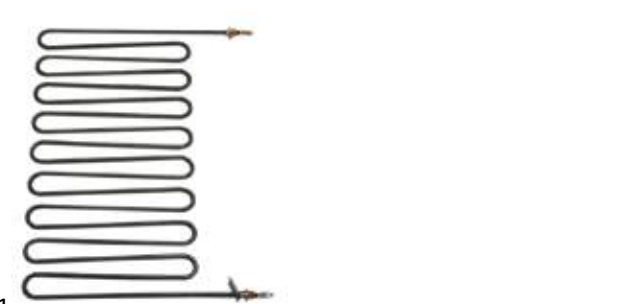

fig.	Vare nr.	P (W)	volt. (V)	L (mm)	W (mm)	tube ø (mm)	Ref. No.
1	415880	2000	230	260	416	6.3	24.10027.400

Eloma

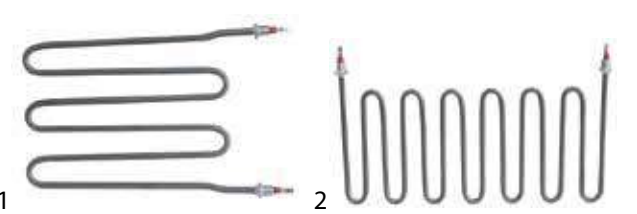

fig.	Vare nr.	P (W)	volt. (V)	L (mm)	W (mm)	tube ø (mm)	Ref. No.
1	416429	1600	230	300	205	8.5	ELE318044
2	416430	2000	230	215	415	8.5	ELE318043



Forved

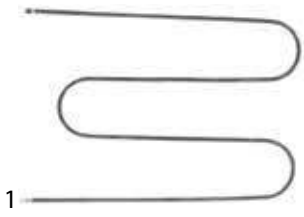

fig.	Vare nr.	P (W)	volt. (V)	L (mm)	W (mm)	tube ø (mm)	Ref. No.
1	419010	600	230	400	280	6.3	VETRRES01

Hatco



fig.	Vare nr.	P (W)	volt. (V)	L (mm)	W (mm)	tube ø (mm)	Ref. No.
1	418720	350	220	133	116	8	X02.05.619.00

Mercury

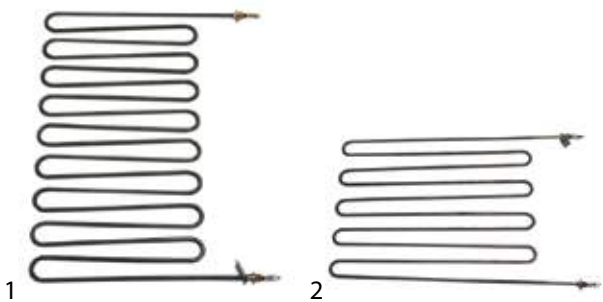

fig.	Vare nr.	P (W)	volt. (V)	L (mm)	W (mm)	tube ø (mm)	Ref. No.
1	415880	2000	230	260	416	6.3	03.7.5022.0
2	415881	2186	230	450	240	6.3	03.7.5028.0

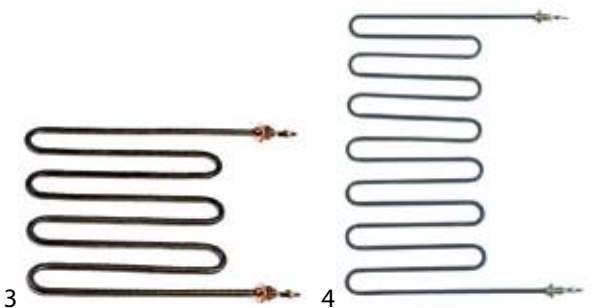

fig.	Vare nr.	P (W)	volt. (V)	L (mm)	W (mm)	tube ø (mm)	Ref. No.
3	415882	2186	230	568	340	6.5	03.7.5023.0
4	415889	1960/2150	230/240	260	380	6.25	03.7.5030.0

Palux

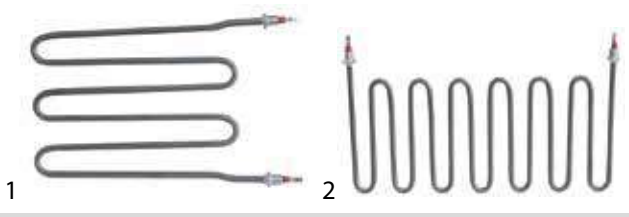

fig.	Vare nr.	P (W)	volt. (V)	L (mm)	W (mm)	tube ø (mm)	Ref. No.
1	416429	1600	230	300	205	8.5	647918
2	416430	2000	230	215	415	8.5	647926

RM-Gastro

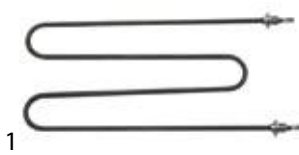

fig.	Vare nr.	P (W)	volt. (V)	L (mm)	W (mm)	tube ø (mm)	Ref. No.
1	415699	400	230	298	138	6.3	401021200
1	418666	700	230	630	160	6.3	401021701

Roller Grill

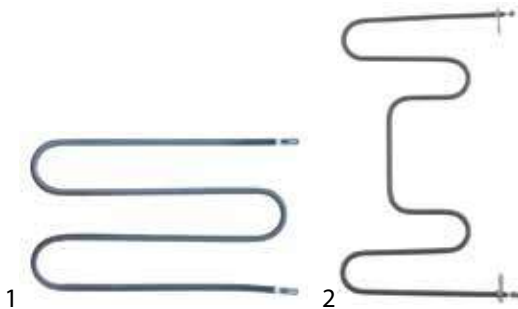

fig.	Vare nr.	P (W)	volt. (V)	L (mm)	W (mm)	tube ø (mm)	Ref. No.
1	416777	500	230	245	147	6.3	D02029
2	420455	650	230	183	330	6.3	D02097

Schöler

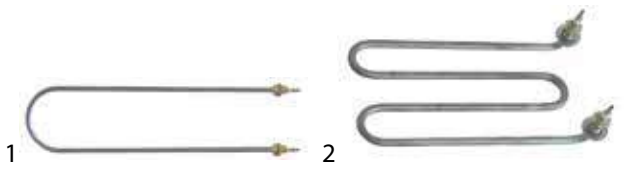

fig.	Vare nr.	P (W)	volt. (V)	L (mm)	W (mm)	tube ø (mm)	Ref. No.
1	416498	600	230	440	120	8.5	—
2	416196	700	230	245	130	8.5	1-K0001



Suprema

fig.	Vare nr.	P (W)	volt. (V)	L (mm)	W (mm)	tube ø (mm)	Ref. No.
1	416498	600	230	440	120	8.5	Mod.901
2	416196	700	230	245	130	8.5	Mod.HV60

fig.	Vare nr.	P (W)	volt. (V)	L (mm)	W (mm)	H (mm)	tube ø (mm)	suitable for	Ref. No.
3	416487	820	230	183	324	-	6.3	Sirman Star10	ATHD071015 71015
4	418661	1000	230	180	187	18	6.2	Bartscher Cookmax RM-Gastro	A0401022500 401022500 401022500

heating elements for hot dog machines

fig.	Vare nr.	P (W)	volt. (V)	L (mm)	W (mm)	H (mm)	tube ø (mm)	suitable for	Ref. No.
1	418656	110	230	131	140	6	6.5	Cookmax RM-Gastro	401020500 401020500
2	415754	600	230	138	134	29	6.5	Jünger	420000

heating elements for coffee machine

Animo

fig.	Vare nr.	P (W)	volt. (V)	HC	L (mm)	W (mm)	H (mm)	tube ø (mm)	ø (mm)	flange (mm)	TS ø (mm)	LTS (mm)	TS	HD (mm)	Ref. No.
1	417315	3200	230	1	137	122	26	6.3					3/4"	03022	
2	417310	6000	230	3	285	37	33	8.5			9	270	1 1/2"	03118	

Astoria

fig.	Vare nr.	P (W)	volt. (V)	HC	L (mm)	W (mm)	H (mm)	tube ø (mm)	ø (mm)	flange (mm)	TS ø (mm)	LTS (mm)	TS	HD (mm)	Ref. No.
1	417006	1300	230	1	110	27	30	6.4					1 1/4"	17201	
2	417090	1450	230	1	132	36	40	6.3					74	—	
3	417579	1700	230	2	175	35	54	8			7	140	74	17003	
4	417039	2000	230	2	185	30	50	8					74	17006	

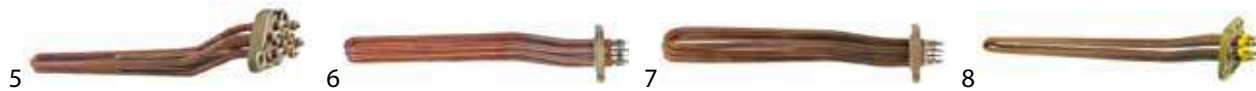

fig.	Vare nr.	P (W)	volt. (V)	HC	L (mm)	W (mm)	H (mm)	tube ø (mm)	ø (mm)	flange (mm)	TS ø (mm)	LTS (mm)	TS	HD (mm)	Ref. No.
5	417107	2600	230	2	295	36	41	8.5			6	186		74	17051
6	417233	3000	230	3	315	30	45	8			6	150		74	17058
7	417000	3400	230	3	305	35	38	8.3			6	155		74	17059
8	417088	3700	230	3	570	35	46	8.5			6	160		74	17104



fig.	Vare nr.	P (W)	volt. (V)	HC	L (mm)	W (mm)	H (mm)	tube ø (mm)	ø (mm)	flange (mm)	TS ø (mm)	LTS (mm)	TS	HD (mm)	Ref. No.
9	417580	5000	230	2	570	32	44	8.5			1	160		74	17106
10	419174	4000/4355	230/240	3	315	38	45	8.5			6	157		75	17057

Aurora



fig.	Vare nr.	P (W)	volt. (V)	HC	L (mm)	W (mm)	H (mm)	tube ø (mm)	ø (mm)	flange (mm)	TS ø (mm)	LTS (mm)	TS	HD (mm)	Ref. No.
1	417263	3000	230/400	3	305	33	33	8			5	148		58	000645.F

Bartscher



fig.	Vare nr.	P (W)	volt. (V)	HC	L (mm)	W (mm)	H (mm)	tube ø (mm)	ø (mm)	flange (mm)	TS ø (mm)	LTS (mm)	TS	HD (mm)	Ref. No.
1	420147			1			42	6.5							A0ND010
2	420146	130	230	1	130	130	54		130						A0ND012

Bezzera



fig.	Vare nr.	P (W)	volt. (V)	HC	L (mm)	W (mm)	H (mm)	tube ø (mm)	ø (mm)	flange (mm)	TS ø (mm)	LTS (mm)	TS	HD (mm)	Ref. No.
1	417168	1300	240	1	47	-	-	8.5	67					44	5722239TP
2	417050	2000	230	2	165	34	52	8.5			6.5	142		40	—
3	417051	2750/3300	220/240	2	338	28	57	8.5			6	160		39	5722242



BFC



fig.	Vare nr.	P (W)	volt. (V)	HC	L (mm)	W (mm)	H (mm)	tube ø (mm)	ø (mm)	flange (mm)	TS ø (mm)	LTS (mm)	TS	HD (mm)	Ref. No.
1	417277	1300	220	1	97	26	26	6.5					1¼"		5050009
2	417273	2400	230	2	210	35	27	8.3			7	195		74	5050710
3	417275	2500	230	2	285	35	24	8.3			7	160	1¼"		5050205

Bianchi Vending



fig.	Vare nr.	P (W)	volt. (V)	HC	L (mm)	W (mm)	H (mm)	tube ø (mm)	ø (mm)	flange (mm)	TS ø (mm)	LTS (mm)	TS	HD (mm)	Ref. No.
1	417048	2400	230	2	235	34	24	8.4					1¼"		29006911

Bonamat

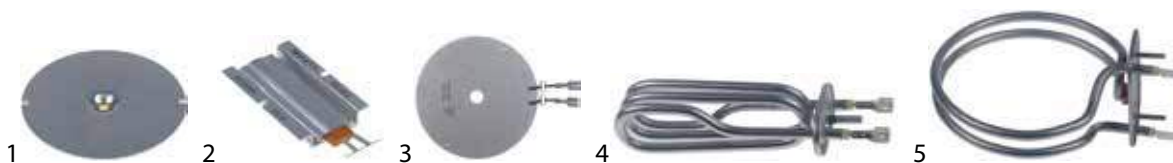

fig.	Vare nr.	P (W)	volt. (V)	HC	L (mm)	W (mm)	H (mm)	tube ø (mm)	ø (mm)	flange (mm)	TS ø (mm)	LTS (mm)	TS	HD (mm)	Ref. No.
1	417486		100-240				8		95						6.284.129.000
2	417324		100-240		75	54	11							42	6.401.076.000
2	417424	65	100-240	1	75	48	11							42	6.240.147.000
2	417423	90	100-240	1	75	48	11							42	6.242.206.000
3	417427	60	230		-	-	1		100						6.240.029.000
4	417408	1200	240	1	115	28	35	6.4		50x26					6.236.158.000
5	417481	1590	240	1	125	125	55	6.4							6.284.028.000



fig.	Vare nr.	P (W)	volt. (V)	HC	L (mm)	W (mm)	H (mm)	tube ø (mm)	ø (mm)	flange (mm)	TS ø (mm)	LTS (mm)	TS	HD (mm)	Ref. No.
6	417478	2270	240	1	155	122	24	6.4		46x22					6.000.262.014

Brasilia

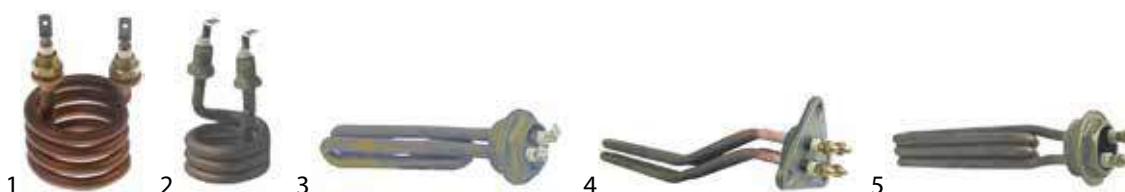

fig.	Vare nr.	P (W)	volt. (V)	HC	L (mm)	W (mm)	H (mm)	tube ø (mm)	ø (mm)	flange (mm)	TS ø (mm)	LTS (mm)	TS	HD (mm)	Ref. No.
1	417280	1000	220	1			60	6.3	50				M10x1		10432.2.00.08
2	417035	1200	230	1			66	8.5	55				1/4"		00625.2.00.08
3	417081	1350	230	1	140	22	23	8.5					1"		01911.2.00.08
4	417030	1800	230	2	177	26	53	8.5						57	00614.2.00.08
5	417032	2000	230	1	170	35	33	8.5					1¼"		00613.2.00.08



fig.	Vare nr.	P (W)	volt. (V)	HC	L (mm)	W (mm)	H (mm)	tube ø (mm)	ø (mm)	flange (mm)	TS ø (mm)	LTS (mm)	TS	HD (mm)	Ref. No.
6	417080	2400	220	1	225	24	38	8					1½"		01378
7	417031	3000	230	2	327	28	52	8.5						59	00615.2.00.08
7	417095	3500	230	2	330	34	53	8.3						57	01834.2.00.08
7	417446	4000	230	2	342	26	51	8						57	00616.2.00.08

Bremer



fig.	Vare nr.	P (W)	volt. (V)	HC	L (mm)	W (mm)	H (mm)	tube ø (mm)	ø (mm)	flange (mm)	TS ø (mm)	LTS (mm)	TS	HD (mm)	Ref. No.
1	415439	2000	230	1	342	33	26	8.5					M12x1		378577
1	415437	3000	220	1	350	33	32	8.6					M12x1		378585
2	415440	3300	220	1	255	67	20	8.5					M12x1		372749

Brugnetti



fig.	Vare nr.	P (W)	volt. (V)	HC	L (mm)	W (mm)	H (mm)	tube ø (mm)	ø (mm)	flange (mm)	TS ø (mm)	LTS (mm)	TS	HD (mm)	Ref. No.
1	417263	3000	230/400	3	305	33	33	8			5	148		58	000645.F

Camurri



fig.	Vare nr.	P (W)	volt. (V)	HC	L (mm)	W (mm)	H (mm)	tube ø (mm)	ø (mm)	flange (mm)	TS ø (mm)	LTS (mm)	TS	HD (mm)	Ref. No.
1	417509	900	230	1	130	44	42	8		26X61					050N0070
2	417510	1500	230	1				6.3	168		7	110	1"		050N0020

Carimali



fig.	Vare nr.	P (W)	volt. (V)	HC	L (mm)	W (mm)	H (mm)	tube ø (mm)	ø (mm)	flange (mm)	TS ø (mm)	LTS (mm)	TS	HD (mm)	Ref. No.
1	417452	1600	230	1	160	32	23	8			6.6	140	1¼"		—
2	417045	1800	230	1	135	36	39	8.5					1¼"		—
3	417046	2000	230	1	200	32	26	8.5			6.5	152	1¼"		95.00985
4	417048	2400	230	2	235	34	24	8.4					1¼"		—





fig.	Vare nr.	P (W)	volt. (V)	HC	L (mm)	W (mm)	H (mm)	tube ø (mm)	ø (mm)	flange (mm)	TS ø (mm)	LTS (mm)	TS	HD (mm)	Ref. No.
5	417616	2800	230	3	153	30	30	6			4	140		58	96.00559
6	417047	3000	230	3	405	29	29	8.5			6.5	195	1¼"		95.01348.10
7	417617	4500	230	3	265	30	30	6			4	140		58	96.00561

CoffeeQueen



fig.	Vare nr.	P (W)	volt. (V)	HC	L (mm)	W (mm)	H (mm)	tube ø (mm)	ø (mm)	flange (mm)	TS ø (mm)	LTS (mm)	TS	HD (mm)	Ref. No.
1	417444	95	230	1				6.4							160101
2	417503	2200	230	1			240	6.5	56				M10x1.5		1601311

Conti



fig.	Vare nr.	P (W)	volt. (V)	HC	L (mm)	W (mm)	H (mm)	tube ø (mm)	ø (mm)	flange (mm)	TS ø (mm)	LTS (mm)	TS	HD (mm)	Ref. No.
1	417100	2800	230	3	245	43	71	8.3						66	—

Cookmax

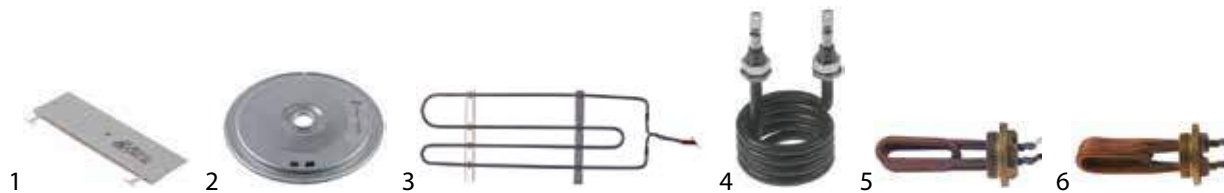

fig.	Vare nr.	P (W)	volt. (V)	HC	L (mm)	W (mm)	H (mm)	tube ø (mm)	ø (mm)	flange (mm)	TS ø (mm)	LTS (mm)	TS	HD (mm)	Ref. No.
1	417456	70	230	1	128	38	2								11624
2	417455	90	240				12		99						11533
3	417458	200	230		500	160	15	6.4							—
4	417453	1000	220	1			62	6	55				M10x1		098645
5	417459	1300	230	1	107	26	26						1¼"		—
6	417006	1300	230	1	110	27	30	6.4					1¼"		WY17201

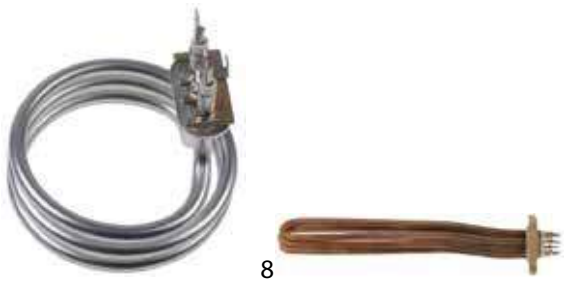



fig.	Vare nr.	P (W)	volt. (V)	HC	L (mm)	W (mm)	H (mm)	tube ø (mm)	ø (mm)	flange (mm)	TS ø (mm)	LTS (mm)	TS	HD (mm)	Ref. No.
7	417454	2000	230	1			63	8.5	93	50x26					15633
8	417000	3400	230	3	305	35	38	8.3			6	155		74	WY17059

Elektra



fig.	Vare nr.	P (W)	volt. (V)	HC	L (mm)	W (mm)	H (mm)	tube ø (mm)	ø (mm)	flange (mm)	TS ø (mm)	LTS (mm)	TS	HD (mm)	Ref. No.
1	417175	800	220	1			41	6.3	50				1/4"		01192035
2	417155	3000	230	3	315	32	45	8						74	00127035

Eloma



fig.	Vare nr.	P (W)	volt. (V)	HC	L (mm)	W (mm)	H (mm)	tube ø (mm)	ø (mm)	flange (mm)	TS ø (mm)	LTS (mm)	TS	HD (mm)	Ref. No.
1	415439	2000	230	1	342	33	26	8.5					M12x1		ELE318039

Expobar



fig.	Vare nr.	P (W)	volt. (V)	HC	L (mm)	W (mm)	H (mm)	tube ø (mm)	ø (mm)	flange (mm)	TS ø (mm)	LTS (mm)	TS	HD (mm)	Ref. No.
1	417528	2000	230	1	108			6.5	38				1/4"		38020001
2	417075	2500	240	1	205	26	48	6						57	38025001
3	417286	3050	230	2	335	34	55	8						57	38027000
4	417267	4500	230	3	320	32	52	8.4						57	38045000

Faema



fig.	Vare nr.	P (W)	volt. (V)	HC	L (mm)	W (mm)	H (mm)	tube ø (mm)	ø (mm)	flange (mm)	TS ø (mm)	LTS (mm)	TS	HD (mm)	Ref. No.
1	417113	1000	230	1			59	6.3	57				M12x1.25		—
2	417083	1500	220	1	165	25	71	8						61	3541118963
3	417002	1500	230	2	140	25	58	8						74	—
4	417116	1800	230	2	240	36	44	8.5			6	205		74	—

Table continues overleaf





fig.	Vare nr.	P (W)	volt. (V)	HC	L (mm)	W (mm)	H (mm)	tube ø (mm)	ø (mm)	flange (mm)	TS ø (mm)	LTS (mm)	TS	HD (mm)	Ref. No.
5	417011	1800	230	3	170	34	35	8.5			7	170		59	421601010
6	417004	2400	230	2	175	27	58	8.5						74	3541116635
7	417001	2600	230	2	330	30	60	8.5			7	195		74	3541133003
8	417108	3500	230	2	380	30	50	8.5			7	190		74	—
8	417202	4000	230	3	295	34	63	8.5			6.5	199		74	911544010
8	417112	4500	230	3	390	35	70	8			6.5	200		74	3541-135 078



fig.	Vare nr.	P (W)	volt. (V)	HC	L (mm)	W (mm)	H (mm)	tube ø (mm)	ø (mm)	flange (mm)	TS ø (mm)	LTS (mm)	TS	HD (mm)	Ref. No.
9	417109	3700	230	2	445	26	54	8			7	208		74	3541133004
10	417110	5000	230	2	525	26	45	8.5			7	210		74	3581130091
11	417581	2440/2900	220/240	2	295	28	50	8.5			7	208		74	3541134417
12	417582	3360/4000	220/240	2	415	30	46	8.5			7	200		74	3541-134418



fig.	Vare nr.	P (W)	volt. (V)	HC	L (mm)	W (mm)	H (mm)	tube ø (mm)	ø (mm)	flange (mm)	TS ø (mm)	LTS (mm)	TS	HD (mm)	Ref. No.
13	417584	5040/6000	220/240	2	620	25	55	8.5			7	210		74	3541-134419
14	417583	4500/5360	220/240	3	392	32	65	8.5			7	150		74	911545010
15	417585	5400/6400	220/240	3	605	34	75	8.5			5.5	150		74	927597010

Fiamma



fig.	Vare nr.	P (W)	volt. (V)	HC	L (mm)	W (mm)	H (mm)	tube ø (mm)	ø (mm)	flange (mm)	TS ø (mm)	LTS (mm)	TS	HD (mm)	Ref. No.
1	417466	1800	230	1	155	21	22	8.3					1"		4.0.000.0218
2	417467	1800	230	2	178	28	46	8.3						57	4.0.000.0214
3	417469	3500	230	2	330	34	55	8.5						57	5.0.000.0802

Fiorenzato-C.S.



fig.	Vare nr.	P (W)	volt. (V)	HC	L (mm)	W (mm)	H (mm)	tube ø (mm)	ø (mm)	flange (mm)	TS ø (mm)	LTS (mm)	TS	HD (mm)	Ref. No.
1	417354	2700	230	3	160	34	45	8.3			7	140		74	A2100146
2	417353	3500	230/400	3	295	34	45	8.3			7	210		74	A2100031
3	417352	4000	230/400	3	545	34	45	8.3			7	210		74	A2100120



Fiorenzato-C.S.



fig.	Vare nr.	P (W)	volt. (V)	HC	L (mm)	W (mm)	H (mm)	tube ø (mm)	ø (mm)	flange (mm)	TS ø (mm)	LTS (mm)	TS	HD (mm)	Ref. No.
1	417354	2700	230	3	160	34	45	8.3			7	140		74	A2100146
2	417353	3500	230/400	3	295	34	45	8.3			7	210		74	A2100031
3	417352	4000	230/400	3	545	34	45	8.3			7	210		74	A2100120

Futurmat



fig.	Vare nr.	P (W)	volt. (V)	HC	L (mm)	W (mm)	H (mm)	tube ø (mm)	ø (mm)	flange (mm)	TS ø (mm)	LTS (mm)	TS	HD (mm)	Ref. No.
1	417116	1800	230	2	240	36	44	8.5			6	205		74	—
2	417001	2600	230	2	330	30	60	8.5			7	195		74	02212439
3	417108	3500	230	2	380	30	50	8.5			7	190		74	08148002
4	417109	3700	230	2	445	26	54	8			7	208		74	02212538



fig.	Vare nr.	P (W)	volt. (V)	HC	L (mm)	W (mm)	H (mm)	tube ø (mm)	ø (mm)	flange (mm)	TS ø (mm)	LTS (mm)	TS	HD (mm)	Ref. No.
5	417110	5000	230	2	525	26	45	8.5			7	210		74	02212637

Gaggia



fig.	Vare nr.	P (W)	volt. (V)	HC	L (mm)	W (mm)	H (mm)	tube ø (mm)	ø (mm)	flange (mm)	TS ø (mm)	LTS (mm)	TS	HD (mm)	Ref. No.
1	417057	1500	230	2	145	23	37	8					1¼"	—	—
2	417022	2000	220	3	228	36	34	8.5						52	—
3	417019	2000	230	3	139	30	30	8.5						43	—
4	417020	4000	230	3	350	32	30	8						43	—



fig.	Vare nr.	P (W)	volt. (V)	HC	L (mm)	W (mm)	H (mm)	tube ø (mm)	ø (mm)	flange (mm)	TS ø (mm)	LTS (mm)	TS	HD (mm)	Ref. No.
5	417110	5000	230	2	525	26	45	8.5			7	210		74	02212637
6	526625	4370/4760	220/240	3	315	33	33	8			6.5	140		51	11003362
6	526624	5000/5950	220/240	3	405	33	33	8			7	140		51	11003363



Grimac



fig.	Vare nr.	P (W)	volt. (V)	HC	L (mm)	W (mm)	H (mm)	tube ø (mm)	ø (mm)	flange (mm)	TS ø (mm)	LTS (mm)	TS	HD (mm)	Ref. No.
1	417006	1300	230	1	110	27	30	6.4					1 1/4"		1240100216
2	417014	1300	230	1	185	40	18	8.5						59	C405
3	417002	1500	230	2	140	25	58	8						74	F351
4	417057	1500	230	2	145	23	37	8					1 1/4"		A080

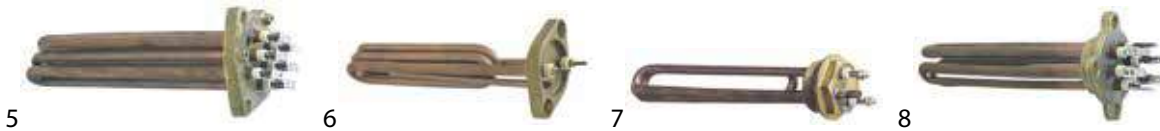

fig.	Vare nr.	P (W)	volt. (V)	HC	L (mm)	W (mm)	H (mm)	tube ø (mm)	ø (mm)	flange (mm)	TS ø (mm)	LTS (mm)	TS	HD (mm)	Ref. No.
5	417011	1800	230	3	170	34	35	8.5			7	170		59	C181
6	417185	2000	230	1	183	28	38	8			5	145		58	SM488
7	417046	2000	230	1	200	32	26	8.5			6.5	152	1 1/4"		CA064
8	417019	2000	230	3	139	30	30	8.5						43	G185



fig.	Vare nr.	P (W)	volt. (V)	HC	L (mm)	W (mm)	H (mm)	tube ø (mm)	ø (mm)	flange (mm)	TS ø (mm)	LTS (mm)	TS	HD (mm)	Ref. No.
9	417004	2400	230	2	175	27	58	8.5						74	F382
10	417107	2600	230	2	295	36	41	8.5			6	186		74	AS021
11	417354	2700	230	3	160	34	45	8.3			7	140		74	A2100146
12	417029	3000	230	2	325	33	28	8			5	125		58	SM489



fig.	Vare nr.	P (W)	volt. (V)	HC	L (mm)	W (mm)	H (mm)	tube ø (mm)	ø (mm)	flange (mm)	TS ø (mm)	LTS (mm)	TS	HD (mm)	Ref. No.
13	417062	3000	230/400	3	238	32	26	8					1 1/4"		P073
14	417358	3300	230	2	230	38	38	8					1 1/4"		GRC102
15	417353	3500	230/400	3	295	34	45	8.3			7	210		74	A2100031
16	417446	4000	230	2	342	26	51	8						57	BF050



fig.	Vare nr.	P (W)	volt. (V)	HC	L (mm)	W (mm)	H (mm)	tube ø (mm)	ø (mm)	flange (mm)	TS ø (mm)	LTS (mm)	TS	HD (mm)	Ref. No.
17	417202	4000	230	3	295	34	63	8.5			6.5	199		74	V583/2
17	417112	4500	230	3	390	35	70	8			6.5	200		74	V583/3
18	417352	4000	230/400	3	545	34	45	8.3			7	210		74	A2100120



Italcrem

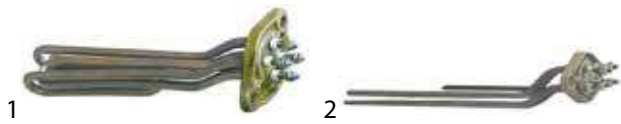

fig.	Vare nr.	P (W)	volt. (V)	HC	L (mm)	W (mm)	H (mm)	tube ø (mm)	ø (mm)	flange (mm)	TS ø (mm)	LTS (mm)	TS	HD (mm)	Ref. No.
1	417116	1800	230	2	240	36	44	8.5			6	205		74	—
2	417001	2600	230	2	330	30	60	8.5			7	195		74	02212439

La Cimbali



fig.	Vare nr.	P (W)	volt. (V)	HC	L (mm)	W (mm)	H (mm)	tube ø (mm)	ø (mm)	flange (mm)	TS ø (mm)	LTS (mm)	TS	HD (mm)	Ref. No.
1	417014	1300	230	1	185	40	18	8.5						59	442-501-005
2	417011	1800	230	3	170	34	35	8.5			7	170		59	421-601-010
3	417013	2850	230/400	3	320	27	35	8.5						59	489-553-020
4	420337	3990	230	3	300	31	25	6.3			7	210		59	802140217



fig.	Vare nr.	P (W)	volt. (V)	HC	L (mm)	W (mm)	H (mm)	tube ø (mm)	ø (mm)	flange (mm)	TS ø (mm)	LTS (mm)	TS	HD (mm)	Ref. No.
5	417202	4000	230	3	295	34	63	8.5			6.5	199		74	911544010
6	419158	3750-4500	220-240	3	380	36	37	8.4			6	150		59	476-513-030

La Marzocco



fig.	Vare nr.	P (W)	volt. (V)	HC	L (mm)	W (mm)	H (mm)	tube ø (mm)	ø (mm)	flange (mm)	TS ø (mm)	LTS (mm)	TS	HD (mm)	Ref. No.
1	417045	1800	230	1	135	36	39	8.5					1¼"		LR340/220B
2	417398	3000	220	1	390	31	31	10					1¼"		LR357/220B

La San Marco

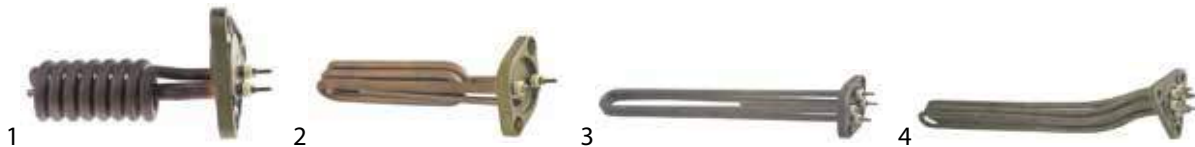

fig.	Vare nr.	P (W)	volt. (V)	HC	L (mm)	W (mm)	H (mm)	tube ø (mm)	ø (mm)	flange (mm)	TS ø (mm)	LTS (mm)	TS	HD (mm)	Ref. No.
1	417351	1750	230	1	135	41	64	8	41					60	108245
2	417185	2000	230	1	183	28	38	8			5	145		58	108414
3	417029	3000	230	2	325	33	28	8			5	125		58	108350
4	417028	3000	230	3	341	33	46	8.5			7	186		62	0796FS



fig.	Vare nr.	P (W)	volt. (V)	HC	L (mm)	W (mm)	H (mm)	tube ø (mm)	ø (mm)	flange (mm)	TS ø (mm)	LTS (mm)	TS	HD (mm)	Ref. No.
5	417297	3500	230	3	370	38	62	8			5	140		61	108630



La-Rocca



fig.	Vare nr.	P (W)	volt. (V)	HC	L (mm)	W (mm)	H (mm)	tube ø (mm)	ø (mm)	flange (mm)	TS ø (mm)	LTS (mm)	TS	HD (mm)	Ref. No.
1	417531	1700	240	1	130	40	40	10						52	10202

La-Spaziale



fig.	Vare nr.	P (W)	volt. (V)	HC	L (mm)	W (mm)	H (mm)	tube ø (mm)	ø (mm)	flange (mm)	TS ø (mm)	LTS (mm)	TS	HD (mm)	Ref. No.
1	417038	2700	230	1			200	8	110				3/8"	—	

Mairali



fig.	Vare nr.	P (W)	volt. (V)	HC	L (mm)	W (mm)	H (mm)	tube ø (mm)	ø (mm)	flange (mm)	TS ø (mm)	LTS (mm)	TS	HD (mm)	Ref. No.
1	417116	1800	230	2	240	36	44	8.5			6	205		74	—
2	417109	3700	230	2	445	26	54	8			7	208		74	02212538

Marcfi



fig.	Vare nr.	P (W)	volt. (V)	HC	L (mm)	W (mm)	H (mm)	tube ø (mm)	ø (mm)	flange (mm)	TS ø (mm)	LTS (mm)	TS	HD (mm)	Ref. No.
1	417072	3000	230	2	355	36	25							52	—

Melitta



fig.	Vare nr.	P (W)	volt. (V)	HC	L (mm)	W (mm)	H (mm)	tube ø (mm)	ø (mm)	flange (mm)	TS ø (mm)	LTS (mm)	TS	HD (mm)	Ref. No.
1	417456	70	230	1	128	38	2								11624
2	417501	90	230	1			2		120						308397
3	417455	90	240				12		99						11533
4	417454	2000	230	1			63	8.5	93	50x26					15633
5	415778	3000	230	1	160	140	28	6.4					3/4"		212113



fig.	Vare nr.	P (W)	volt. (V)	HC	L (mm)	W (mm)	H (mm)	tube ø (mm)	ø (mm)	flange (mm)	TS ø (mm)	LTS (mm)	TS	HD (mm)	Ref. No.
6	417461	3810	230	1	375	165		8.5		47x24					12134

N&W



fig.	Vare nr.	P (W)	volt. (V)	HC	L (mm)	W (mm)	H (mm)	tube ø (mm)	ø (mm)	flange (mm)	TS ø (mm)	LTS (mm)	TS	HD (mm)	Ref. No.
1	417453	1000	220	1			62	6	55				M10x1		098645

NuovaSimonelli

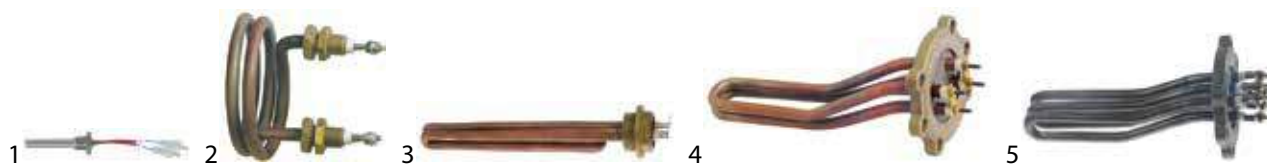

fig.	Vare nr.	P (W)	volt. (V)	HC	L (mm)	W (mm)	H (mm)	tube ø (mm)	ø (mm)	flange (mm)	TS ø (mm)	LTS (mm)	TS	HD (mm)	Ref. No.
1	417194	600	230	1	74				10				3/8"		14100037
2	417132	1200	230	1			42	8	88				1/4"		14100008
3	417195	1200	230	1	155	22	22	8.5			7	160	1"		14100040
3	417190	1800	220	1	175	20	28	8.5					1"		14100029
4	417052	1800	230	2	180	31	46	8.5						54/76	14100084
5	417293	1800	230	3	155	36	50	8.5						77	14100084

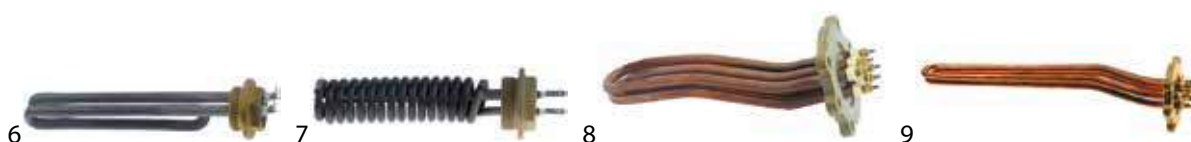

fig.	Vare nr.	P (W)	volt. (V)	HC	L (mm)	W (mm)	H (mm)	tube ø (mm)	ø (mm)	flange (mm)	TS ø (mm)	LTS (mm)	TS	HD (mm)	Ref. No.
6	417490	2300	230	1	172	22	25	8.5					1"		14100054
7	417228	2600	230	1	155	52	52	6.3	35		7.5	150	1 1/4"		14100088
8	417131	2700	230	3	182	32	52	8						77	14100027
9	417053	3000	230	3	330	38	55	8.5						55	14100011



fig.	Vare nr.	P (W)	volt. (V)	HC	L (mm)	W (mm)	H (mm)	tube ø (mm)	ø (mm)	flange (mm)	TS ø (mm)	LTS (mm)	TS	HD (mm)	Ref. No.
10	417184	4500	230	2	335	37	51	8.5						55	14100031



Palux



fig.	Vare nr.	P (W)	volt. (V)	HC	L (mm)	W (mm)	H (mm)	tube ø (mm)	ø (mm)	flange (mm)	TS ø (mm)	LTS (mm)	TS	HD (mm)	Ref. No.	
1	415439	2000	230	1	342	33	26	8.5							M12x1	378577
1	415437	3000	220	1	350	33	32	8.6							M12x1	378585
2	415440	3300	220	1	255	67	20	8.5							M12x1	372749

Pavoni

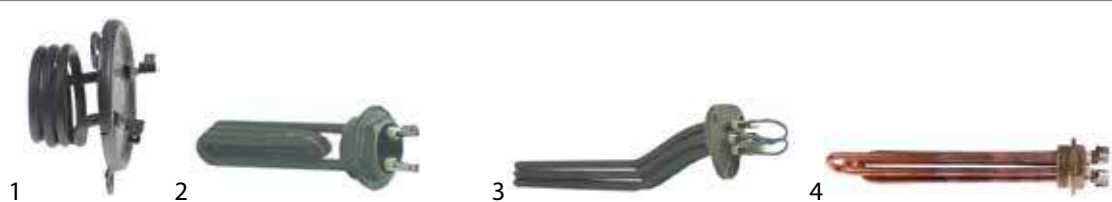

fig.	Vare nr.	P (W)	volt. (V)	HC	L (mm)	W (mm)	H (mm)	tube ø (mm)	ø (mm)	flange (mm)	TS ø (mm)	LTS (mm)	TS	HD (mm)	Ref. No.
1	417385	920	230	1	50	59	96	6.5	59					80	331335
2	417045	1800	230	1	135	36	39	8.5					1 1/4"		—
3	417059	3000	230	3	223	30	67	8.5						52	—
4	417062	3000	230/400	3	238	32	26	8					1 1/4"		—



fig.	Vare nr.	P (W)	volt. (V)	HC	L (mm)	W (mm)	H (mm)	tube ø (mm)	ø (mm)	flange (mm)	TS ø (mm)	LTS (mm)	TS	HD (mm)	Ref. No.
5	417382	2870/3130	230/240	3	235	32	33	8			6.5	140		51	2310003001

Project



fig.	Vare nr.	P (W)	volt. (V)	HC	L (mm)	W (mm)	H (mm)	tube ø (mm)	ø (mm)	flange (mm)	TS ø (mm)	LTS (mm)	TS	HD (mm)	Ref. No.
1	417568	800	220	1	75	40									PTC02

QualityEspresso

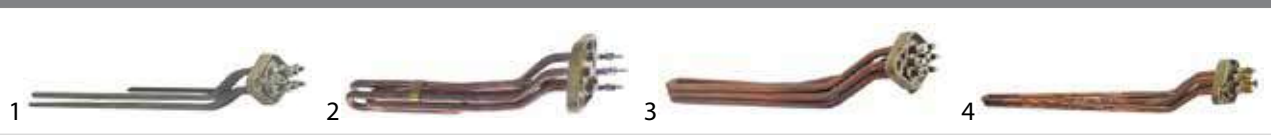

fig.	Vare nr.	P (W)	volt. (V)	HC	L (mm)	W (mm)	H (mm)	tube ø (mm)	ø (mm)	flange (mm)	TS ø (mm)	LTS (mm)	TS	HD (mm)	Ref. No.
1	417001	2600	230	2	330	30	60	8.5			7	195		74	02212439
2	417290	3000	230	2	250	28	65	8.3			7	210		74	08024804
3	417108	3500	230	2	380	30	50	8.5			7	190		74	08148002
4	417109	3700	230	2	445	26	54	8			7	208		74	02212538



Rancilio



fig.	Vare nr.	P (W)	volt. (V)	HC	L (mm)	W (mm)	H (mm)	tube ø (mm)	ø (mm)	flange (mm)	TS ø (mm)	LTS (mm)	TS	HD (mm)	Ref. No.
1	417009	2100	230	3	220	29	50							62	36322022
1	417176	3000	230	3	215	42	50							62	33322028
2	417135	3900	230	3	391	35	51							63	33322039

Royal



fig.	Vare nr.	P (W)	volt. (V)	HC	L (mm)	W (mm)	H (mm)	tube ø (mm)	ø (mm)	flange (mm)	TS ø (mm)	LTS (mm)	TS	HD (mm)	Ref. No.
1	417277	1300	220	1	97	26	26	6.5					1¼"		5050009
2	417273	2400	230	2	210	35	27	8.3			7	195		74	5050710
3	417275	2500	230	2	285	35	24	8.3			7	160	1¼"		5050205

Sanremo



fig.	Vare nr.	P (W)	volt. (V)	HC	L (mm)	W (mm)	H (mm)	tube ø (mm)	ø (mm)	flange (mm)	TS ø (mm)	LTS (mm)	TS	HD (mm)	Ref. No.
1	417280	1000	220	1			60	6.3	50				M10x1		10455014
2	417378	2700	230	3	325	34	35	8.5			7	220	1¼"		10455052
2	417379	4500	230	3	325	35	35	8.5			7	220	1¼"		10455080

Solenry



fig.	Vare nr.	P (W)	volt. (V)	HC	L (mm)	W (mm)	H (mm)	tube ø (mm)	ø (mm)	flange (mm)	TS ø (mm)	LTS (mm)	TS	HD (mm)	Ref. No.
1	417145	2000	230	1	328	25	37						1¼"		—

SV-Italia



fig.	Vare nr.	P (W)	volt. (V)	HC	L (mm)	W (mm)	H (mm)	tube ø (mm)	ø (mm)	flange (mm)	TS ø (mm)	LTS (mm)	TS	HD (mm)	Ref. No.
1	417417	3000	230	2	343	34	62	6.3						57.5	SV2GR003



VFA-Express



fig.	Vare nr.	P (W)	volt. (V)	HC	L (mm)	W (mm)	H (mm)	tube ø (mm)	ø (mm)	flange (mm)	TS ø (mm)	LTS (mm)	TS	HD (mm)	Ref. No.
1	417090	1450	230	1	132	36	40	6.3						74	521911/1

Vibiemme



fig.	Vare nr.	P (W)	volt. (V)	HC	L (mm)	W (mm)	H (mm)	tube ø (mm)	ø (mm)	flange (mm)	TS ø (mm)	LTS (mm)	TS	HD (mm)	Ref. No.
1	417081	1350	230	1	140	22	23	8.5					1"		ELETRESD1422
2	417498	1800	230	1	140	26	26	8.5					1 1/4"		ELETRESSM1822
3	417030	1800	230	2	177	26	53	8.5						57	ELETRES1G1822
4	417150	2700	230	2	252	26	65							57	ELETRES2G2722



fig.	Vare nr.	P (W)	volt. (V)	HC	L (mm)	W (mm)	H (mm)	tube ø (mm)	ø (mm)	flange (mm)	TS ø (mm)	LTS (mm)	TS	HD (mm)	Ref. No.
5	417446	4000	230	2	342	26	51	8						57	ELETRES2G4023
5	417439	5000	230	2	455	25	51							57	ELETRES3G5023

Visacrem



fig.	Vare nr.	P (W)	volt. (V)	HC	L (mm)	W (mm)	H (mm)	tube ø (mm)	ø (mm)	flange (mm)	TS ø (mm)	LTS (mm)	TS	HD (mm)	Ref. No.
1	417116	1800	230	2	240	36	44	8.5			6	205		74	—
2	417109	3700	230	2	445	26	54	8			7	208		74	02212538
3	417110	5000	230	2	525	26	45	8.5			7	210		74	02212637

WEGA



fig.	Vare nr.	P (W)	volt. (V)	HC	L (mm)	W (mm)	H (mm)	tube ø (mm)	ø (mm)	flange (mm)	TS ø (mm)	LTS (mm)	TS	HD (mm)	Ref. No.
1	417458	200	230		500	160	15	6.4							WY17022
2	417459	1300	230	1	107	26	26						1 1/4"		WY17202
3	417006	1300	230	1	110	27	30	6.4					1 1/4"		WY17201
4	417090	1450	230	1	132	36	40	6.3						74	—
5	417043	1800	230	3	175	35	30	8						74	W10451





fig.	Vare nr.	P (W)	volt. (V)	HC	L (mm)	W (mm)	H (mm)	tube ø (mm)	ø (mm)	flange (mm)	TS ø (mm)	LTS (mm)	TS	HD (mm)	Ref. No.
6	417107	2600	230	2	295	36	41	8.5			6	186		74	17051
7	417154	2700	230	3	185	32	50	8						74	—
8	417155	3000	230	3	315	32	45	8						74	W05152
9	417000	3400	230	3	305	35	38	8.3			6	155		74	WY17059



fig.	Vare nr.	P (W)	volt. (V)	HC	L (mm)	W (mm)	H (mm)	tube ø (mm)	ø (mm)	flange (mm)	TS ø (mm)	LTS (mm)	TS	HD (mm)	Ref. No.
10	417112	4500	230	3	390	35	70	8			6.5	200		74	—
11	419174	4000/4355	230/240	3	315	38	45	8.5			6	157		75	WY17057

heating elements for refrigeration

Afinox

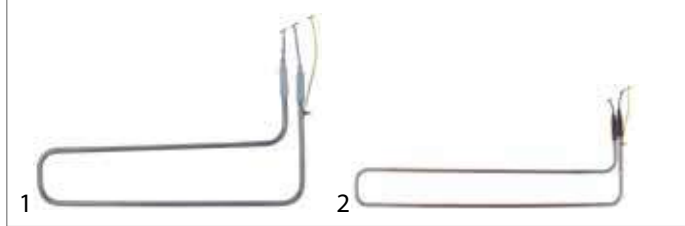

fig.	Vare nr.	P (W)	volt. (V)	L (mm)	W (mm)	Ref. No.
1	417597	400	230	375	190	73636302
2	417596	600	230	580	190	73636304

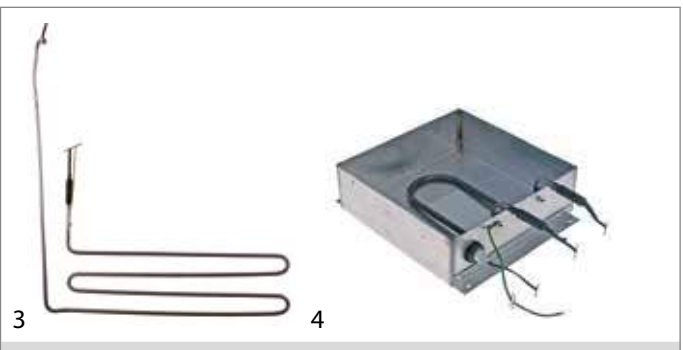

fig.	Vare nr.	P (W)	volt. (V)	L (mm)	W (mm)	Ref. No.
3	418752	350	230	495	400	1666355
4	750003	650	230	240	240	226303600
4	750004	750	230	380	240	227206000

Coldline



fig.	Vare nr.	P (W)	volt. (V)	L (mm)	W (mm)	Ref. No.
1	417515	150	230	630	60	R911015010



fig.	Vare nr.	P (W)	volt. (V)	L (mm)	W (mm)	Ref. No.
5	418732	650	230	280	95	877107800
5	418733	750	230	430	95	877107900

Cookmax



fig.	Vare nr.	P (W)	volt. (V)	L (mm)	W (mm)	Ref. No.
1	750007	300	230	280	130	224011500
2	418731	300	230	285	80	877111800

Coreco



fig.	Vare nr.	P (W)	volt. (V)	L (mm)	W (mm)	Ref. No.
1	417527	350	230	380	115	6021250021



Desmon



fig.	Vare nr.	P (W)	volt. (V)	L (mm)	W (mm)	Ref. No.
1	417587	350	230	380	-	R35-0070
2	420241	750	230	415	100	R35-0123

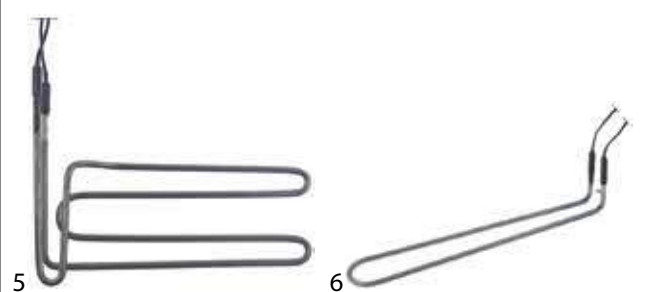

fig.	Vare nr.	P (W)	volt. (V)	L (mm)	W (mm)	Ref. No.
5	420450	335	220	255	315	083093
6	419025	400	230	440	70	083530
6	419101	450	230	380	37	0A9683

Dexion

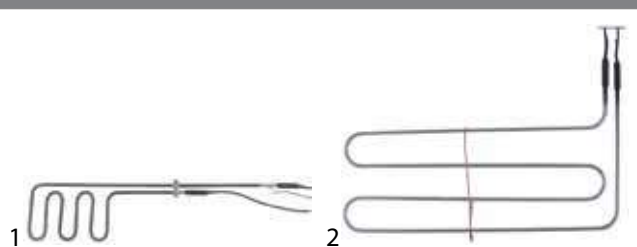

fig.	Vare nr.	P (W)	volt. (V)	L (mm)	W (mm)	Ref. No.
1	416374	135	230	480	115	019430-02R
2	416312	550	230	420	210	011526-01



fig.	Vare nr.	P (W)	volt. (V)	L (mm)	W (mm)	Ref. No.
7	420451	480	230	365	200	088377
8	420452	540	220	305	695	0780082279

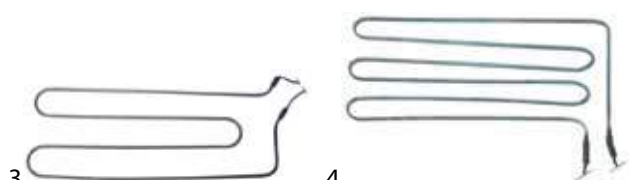

fig.	Vare nr.	P (W)	volt. (V)	L (mm)	W (mm)	Ref. No.
3	416418	550	230	440	160	01447401R
3	420338	550	230	440	180	022258-02R
4	420393	750	230	425	350	019014-00R

Fagor

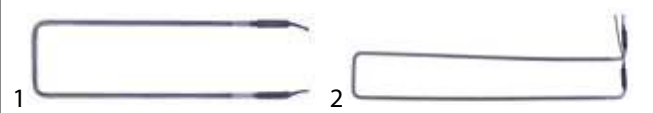

fig.	Vare nr.	P (W)	volt. (V)	L (mm)	W (mm)	Ref. No.
1	417221	350	230	360	115	12034637
1	417527	350	230	380	115	12033938
2	417223	650	220	660	180	12037967

Electrolux

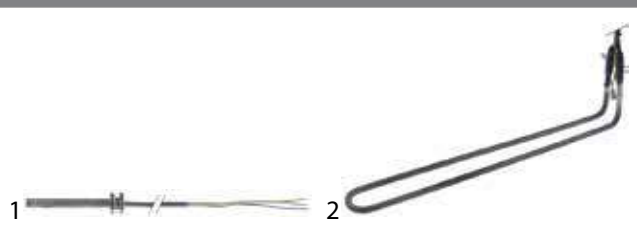

fig.	Vare nr.	P (W)	volt. (V)	L (mm)	W (mm)	Ref. No.
1	417227	90	230	124	-	083814
2	420447	95	230	425	48	082731

Forcar



fig.	Vare nr.	P (W)	volt. (V)	L (mm)	W (mm)	Ref. No.
1	420150	400	230	290	75	RC0136

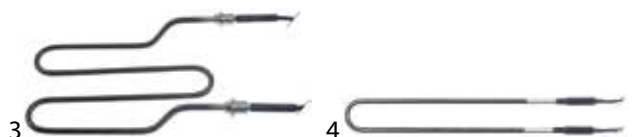

fig.	Vare nr.	P (W)	volt. (V)	L (mm)	W (mm)	Ref. No.
3	420448	120	220	198	114	082188
4	420449	160	220	370	60	082733

Foster



fig.	Vare nr.	P (W)	volt. (V)	L (mm)	W (mm)	Ref. No.
1	420434	975	240	1020	70	15843061



Frenox



fig.	Vare nr.	P (W)	volt. (V)	L (mm)	W (mm)	Ref. No.
1	419196	55	220	410	50	B00REZ100
2	419200	1080	220	1065	170	B00REZ114



fig.	Vare nr.	P (W)	volt. (V)	L (mm)	W (mm)	Ref. No.
3	419195	2x100	2x115	380	-	B00REZ116
3	419197	2x200	2x110	400	-	B00REZ111

Friulinox



fig.	Vare nr.	P (W)	volt. (V)	L (mm)	W (mm)	Ref. No.
1	418566	80	230	505	80	FR995581

IME Turbo

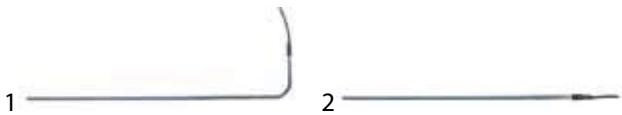

fig.	Vare nr.	P (W)	volt. (V)	L (mm)	W (mm)	Ref. No.
1	416352	100	230	550	115	TKS0319
2	416351	160	230	450	-	TKS0012

Inomak

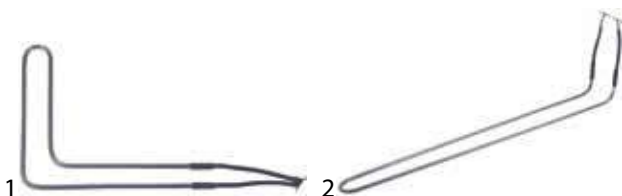

fig.	Vare nr.	P (W)	volt. (V)	L (mm)	W (mm)	Ref. No.
1	420025			120	320	34500040100191
1	420024	150	230	190	215	34500040100660
2	420270	700	230	490	40	34500040100688

Lohberger



fig.	Vare nr.	P (W)	volt. (V)	L (mm)	W (mm)	Ref. No.
1	417227	90	230	124	-	PO1666090
2	419208	250	230	420	50	PO1666250

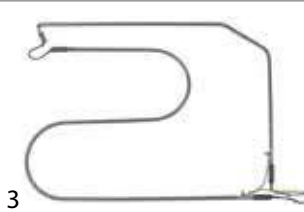

fig.	Vare nr.	P (W)	volt. (V)	L (mm)	W (mm)	Ref. No.
3	419207	350	230	510	340	PO1666352

Mafrol



fig.	Vare nr.	P (W)	volt. (V)	L (mm)	W (mm)	Ref. No.
1	750007	300	230	280	130	224011500
2	418731	300	230	285	80	877111800

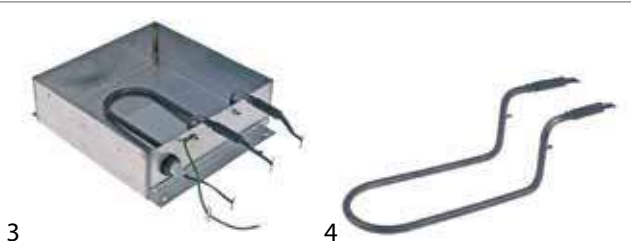

fig.	Vare nr.	P (W)	volt. (V)	L (mm)	W (mm)	Ref. No.
3	750003	650	230	240	240	226303600
3	750004	750	230	380	240	227206000
4	418732	650	230	280	95	877107800
4	418733	750	230	430	95	877107900

Mareno

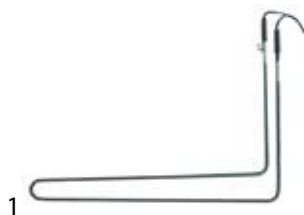

fig.	Vare nr.	P (W)	volt. (V)	L (mm)	W (mm)	Ref. No.
1	416325	105	230	410	295	MA2476935



MBM-Italia

fig.	Vare nr.	P (W)	volt. (V)	L (mm)	W (mm)	Ref. No.
1	416374	135	230	480	115	RIC0003315
2	416312	550	230	420	210	RIC0002969

fig.	Vare nr.	P (W)	volt. (V)	L (mm)	W (mm)	Ref. No.
3	416418	550	230	440	160	01447401R
3	420338	550	230	440	180	—
4	420393	750	230	425	350	—

Polaris

fig.	Vare nr.	P (W)	volt. (V)	L (mm)	W (mm)	Ref. No.
1	417227	90	230	124	-	BN1666090
2	420170	95	230	400	60	BN1666096
2	419208	250	230	420	50	BN1666250

fig.	Vare nr.	P (W)	volt. (V)	L (mm)	W (mm)	Ref. No.
3	419209	270	230	380	120	BN1666400
4	418752	350	230	495	400	BN1666355

fig.	Vare nr.	P (W)	volt. (V)	L (mm)	W (mm)	Ref. No.
5	419207	350	230	510	340	BN1666352

Tecrigo

fig.	Vare nr.	P (W)	volt. (V)	L (mm)	W (mm)	Ref. No.
1	418816	500	230	500	130	7764819

Whirlpool

fig.	Vare nr.	P (W)	volt. (V)	L (mm)	W (mm)	Ref. No.
1	417227	90	230	124	-	—
2	420447	95	230	425	48	182731

fig.	Vare nr.	P (W)	volt. (V)	L (mm)	W (mm)	Ref. No.
3	420449	160	220	370	60	—
4	420450	335	220	255	315	—

fig.	Vare nr.	P (W)	volt. (V)	L (mm)	W (mm)	Ref. No.
5	419025	400	230	440	70	183530
5	419101	450	230	380	37	—
6	420452	540	220	305	695	182279

Williams

fig.	Vare nr.	P (W)	volt. (V)	L (mm)	W (mm)	Ref. No.
1	420442	500	240	500	35	HEATER310



Zanussi

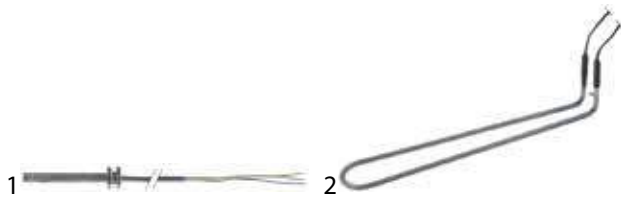

fig.	Vare nr.	P (W)	volt. (V)	L (mm)	W (mm)	Ref. No.
1	417227	90	230	124	-	083814
2	419025	400	230	440	70	083530

Zoin



fig.	Vare nr.	P (W)	volt. (V)	L (mm)	W (mm)	Ref. No.
1	416984	270	230	230	36	R010-RMU251

heating elements for tilting bratt pan

Ambach

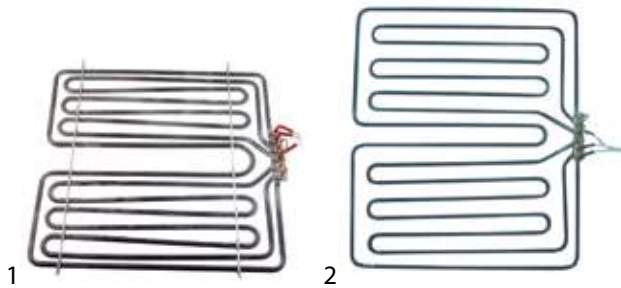

fig.	Vare nr.	P (W)	volt. (V)	L (mm)	W (mm)	H (mm)	Ref. No.
1	416960	9000	400	426	410	33	5060808751
2	415900	9000	230/400	520	600	33	5060807221
2	415901	12000	230/400	475	700	33	5060803648

Angelo-Po



fig.	Vare nr.	P (W)	volt. (V)	L (mm)	W (mm)	H (mm)	Ref. No.
1	416597	2000	230	530	93	70	32G2481

Baron

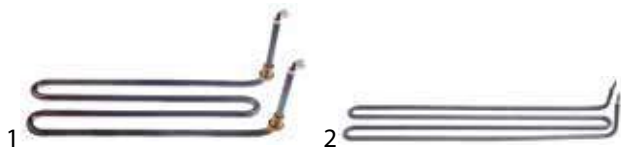

fig.	Vare nr.	P (W)	volt. (V)	L (mm)	W (mm)	H (mm)	Ref. No.
1	418039	1200	230	292	86	20	BN41826620090
2	415076	1300	230	490	78	70	MA1037300713

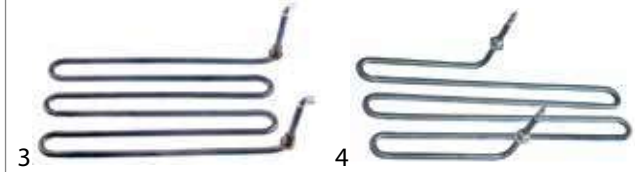

fig.	Vare nr.	P (W)	volt. (V)	L (mm)	W (mm)	H (mm)	Ref. No.
3	417164	2000	230	290	143	26	BN826620120
4	416805	2350	230	400	160	55	BN6A050210

Bertoss

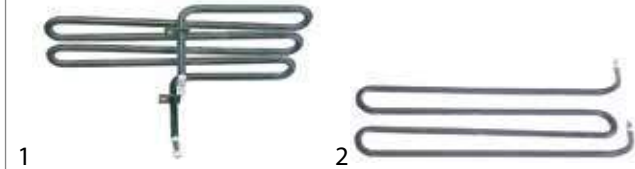

fig.	Vare nr.	P (W)	volt. (V)	L (mm)	W (mm)	H (mm)	Ref. No.
1	415077	1300	230	280	150	40	22039800
2	416002	3000	240	390	120	68	31927000

Capic

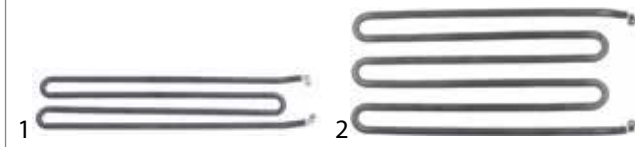

fig.	Vare nr.	P (W)	volt. (V)	L (mm)	W (mm)	H (mm)	Ref. No.
1	418938	2500	230	520	110	35	E151125
2	420167	3000	230	425	190	30	E151135

Charvet



fig.	Vare nr.	P (W)	volt. (V)	L (mm)	W (mm)	H (mm)	Ref. No.
1	420233	3300	230	565	84	118	07668A

Cookmax

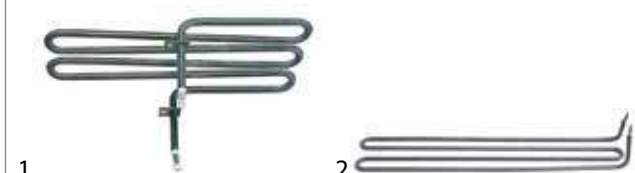



fig.	Vare nr.	P (W)	volt. (V)	L (mm)	W (mm)	H (mm)	Ref. No.
1	415077	1300	230	280	150	40	1037301713
2	415076	1300	230	490	78	70	1037300713

3

fig.	Vare nr.	P (W)	volt. (V)	L (mm)	W (mm)	H (mm)	Ref. No.
3	416805	2350	230	400	160	55	A050210

EGO

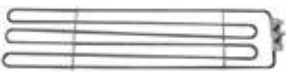

1

fig.	Vare nr.	P (W)	volt. (V)	L (mm)	W (mm)	H (mm)	Ref. No.
1	415593	2565	230	554	125	30	20.21759.000
1	415594	2565	400	556	126	33	20.21759.060

EKU



1



2

fig.	Vare nr.	P (W)	volt. (V)	L (mm)	W (mm)	H (mm)	Ref. No.
1	415077	1300	230	280	150	40	TYP 1-W-240
2	415076	1300	230	490	78	70	373.007.0 1-W-237



3

fig.	Vare nr.	P (W)	volt. (V)	L (mm)	W (mm)	H (mm)	Ref. No.
3	415250	1650	230	490	42	45	4-FI-18

Electrolux



1

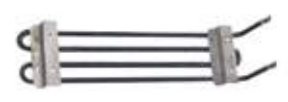

2

fig.	Vare nr.	P (W)	volt. (V)	L (mm)	W (mm)	H (mm)	Ref. No.
1	415381	1300	220	535	82	100	051355
2	415273	1500	220	373	82	78	058345



3



4

fig.	Vare nr.	P (W)	volt. (V)	L (mm)	W (mm)	H (mm)	Ref. No.
3	418016	1500	230	375	76	75	002559
4	415822	1800	230	540	105	-	0H6707



5

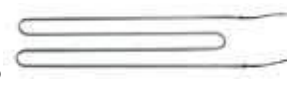

6

fig.	Vare nr.	P (W)	volt. (V)	L (mm)	W (mm)	H (mm)	Ref. No.
5	418504	2500	230	538	81	44	0C0686
6	415355	2500	230	612	130	8.5	0K4810

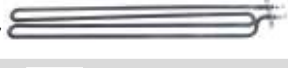

7



8

fig.	Vare nr.	P (W)	volt. (V)	L (mm)	W (mm)	H (mm)	Ref. No.
7	418005	2500	400	545	80	48	0C0685
8	418003	3000	230	137	515	48	004469
8	420131	3500	230	145	623	50	0C2613



9

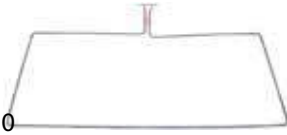

10

fig.	Vare nr.	P (W)	volt. (V)	L (mm)	W (mm)	H (mm)	Ref. No.
9	420128	3000	230	500	165	48	0K4745
10	420238	3000	230	525	975	-	0K4746

Fagor



1



2

fig.	Vare nr.	P (W)	volt. (V)	L (mm)	W (mm)	H (mm)	Ref. No.
1	416607	1500	230	417	95	46	12024620
1	416616	2000	230	525	82	46	12024617
2	416615	2000	230	523	95	81	12018865

Falcon



1

fig.	Vare nr.	P (W)	volt. (V)	L (mm)	W (mm)	H (mm)	Ref. No.
1	418874	3200	240	457	185	55	731750421
1	418875	3200	240	457	185	55	731750420



Firex



fig.	Vare nr.	P (W)	volt. (V)	L (mm)	W (mm)	H (mm)	Ref. No.
1	416692	2900	230	312	200	82	40400082

Gico

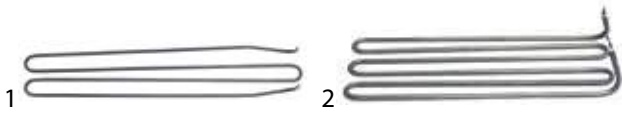

fig.	Vare nr.	P (W)	volt. (V)	L (mm)	W (mm)	H (mm)	Ref. No.
1	416140	2300	230	510	90	45	290202450
2	416114	2600	230	375	152	58	270200812

GIGA

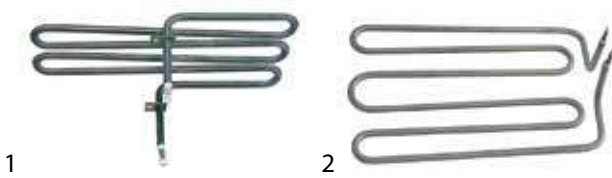

fig.	Vare nr.	P (W)	volt. (V)	L (mm)	W (mm)	H (mm)	Ref. No.
1	415077	1300	230	280	150	40	Y00100
2	416045	3400	230	313	195	82	X48100



fig.	Vare nr.	P (W)	volt. (V)	L (mm)	W (mm)	H (mm)	Ref. No.
3	417344	4700	230	540	210	60	Y10500

Juno



fig.	Vare nr.	P (W)	volt. (V)	L (mm)	W (mm)	H (mm)	Ref. No.
1	415273	1500	220	373	82	78	058345
2	415822	1800	230	540	105	-	0H6707

Krefft



fig.	Vare nr.	P (W)	volt. (V)	L (mm)	W (mm)	H (mm)	Ref. No.
1	415593	2565	230	554	125	30	49-182330
1	415594	2565	400	556	126	33	49-182329

Küppersbusch

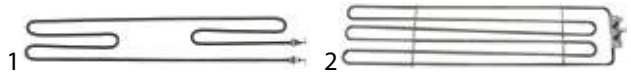

fig.	Vare nr.	P (W)	volt. (V)	L (mm)	W (mm)	H (mm)	Ref. No.
1	416944	1800	235	565	85	-	160120
2	415593	2565	230	554	125	30	160104
2	415594	2565	400	556	126	33	182329

Lotus



fig.	Vare nr.	P (W)	volt. (V)	L (mm)	W (mm)	H (mm)	Ref. No.
1	416692	2900	230	312	200	82	40400082

Mareno

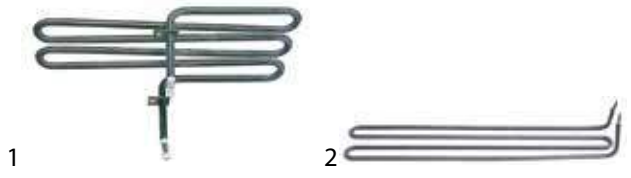

fig.	Vare nr.	P (W)	volt. (V)	L (mm)	W (mm)	H (mm)	Ref. No.
1	415077	1300	230	280	150	40	MA1037301713
2	415076	1300	230	490	78	70	MA1037300713

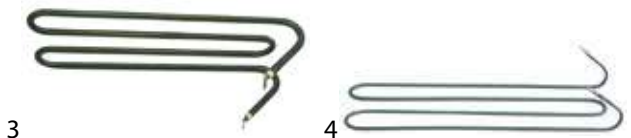

fig.	Vare nr.	P (W)	volt. (V)	L (mm)	W (mm)	H (mm)	Ref. No.
3	415973	2700	240	360	141	85	MA1686900
4	415084	3900	240	520	170	94	MA1878700

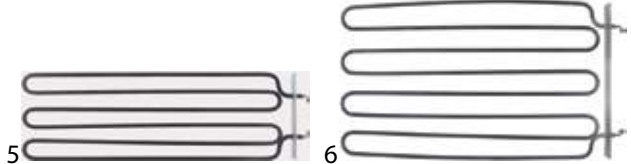

fig.	Vare nr.	P (W)	volt. (V)	L (mm)	W (mm)	H (mm)	Ref. No.
5	420104	5000	230	555	180	30	CR0683221
6	420106	6350	230	550	320	24	CR0684240



MBM-Italia

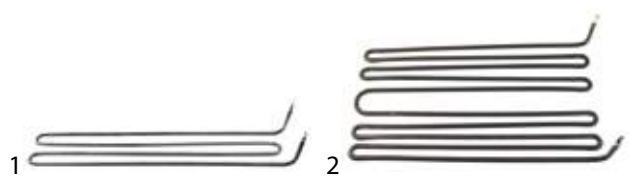

fig.	Vare nr.	P (W)	volt. (V)	L (mm)	W (mm)	H (mm)	Ref. No.
1	417335	1500	240	500	90	70	RTBF800026
2	417333	3000	240	400	200	65	RTCU700646

MKN

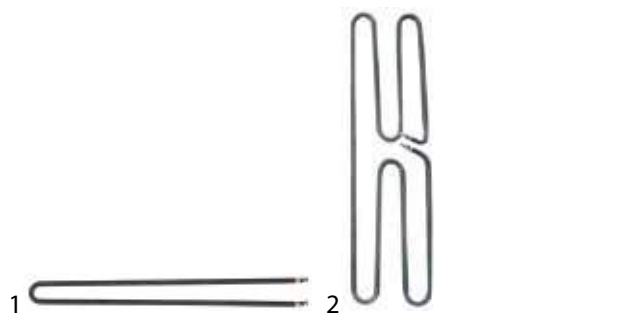

fig.	Vare nr.	P (W)	volt. (V)	L (mm)	W (mm)	H (mm)	Ref. No.
1	418303	1200	230	510	45	-	574107
2	415477	1670	230	95	465	45	574102
2	415475	1670	230	110	430	45	574084

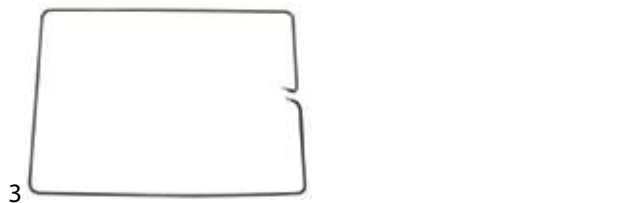

fig.	Vare nr.	P (W)	volt. (V)	L (mm)	W (mm)	H (mm)	Ref. No.
3	415476	1670	230	650	470	35	574085

Modular



fig.	Vare nr.	P (W)	volt. (V)	L (mm)	W (mm)	H (mm)	Ref. No.
1	416539	2100	230	383	170	60	66502300
1	416540	3330	230	506	200	63	96500715

Morice



fig.	Vare nr.	P (W)	volt. (V)	L (mm)	W (mm)	H (mm)	Ref. No.
1	420256	1000	230	460	100	64	RS0909
1	420257	2000	230	445	100	72	RS0898

Multi



fig.	Vare nr.	P (W)	volt. (V)	L (mm)	W (mm)	H (mm)	Ref. No.
1	415930	3440	240	530	205	60	965007

Offcar



fig.	Vare nr.	P (W)	volt. (V)	L (mm)	W (mm)	H (mm)	Ref. No.
1	416692	2900	230	312	200	82	FX40400082

Olis



fig.	Vare nr.	P (W)	volt. (V)	L (mm)	W (mm)	H (mm)	Ref. No.
1	417164	2000	230	290	143	26	BN826620120
2	416805	2350	230	400	160	55	BN6A050210



fig.	Vare nr.	P (W)	volt. (V)	L (mm)	W (mm)	H (mm)	Ref. No.
3	416806	3490	230	480	185	65	BN6A050190

Palux

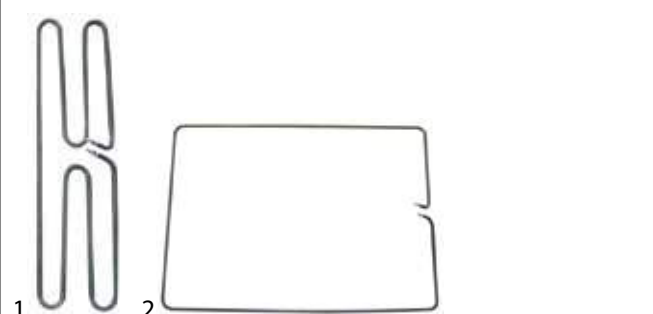

fig.	Vare nr.	P (W)	volt. (V)	L (mm)	W (mm)	H (mm)	Ref. No.
1	415477	1670	230	95	465	45	194700
1	415475	1670	230	110	430	45	290734
2	415476	1670	230	650	470	35	290742



Rosinox

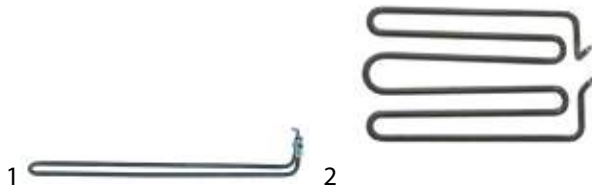

fig.	Vare nr.	P (W)	volt. (V)	L (mm)	W (mm)	H (mm)	Ref. No.
1	415250	1650	230	490	42	45	RX94800224
2	415298	3400	230	315	195	85	RX94806718

Silko



fig.	Vare nr.	P (W)	volt. (V)	L (mm)	W (mm)	H (mm)	Ref. No.
1	415076	1300	230	490	78	70	MA1037300713
2	415250	1650	230	490	42	45	SIR0101527

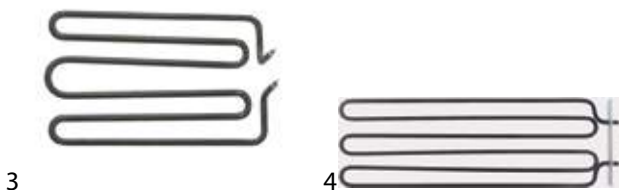

fig.	Vare nr.	P (W)	volt. (V)	L (mm)	W (mm)	H (mm)	Ref. No.
3	415298	3400	230	315	195	85	SIR0101526
4	420104	5000	230	555	180	30	CR0683221

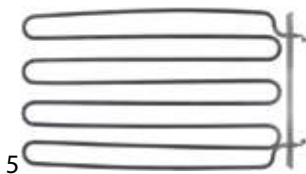

fig.	Vare nr.	P (W)	volt. (V)	L (mm)	W (mm)	H (mm)	Ref. No.
5	420106	6350	230	550	320	24	CR0684240

Star10

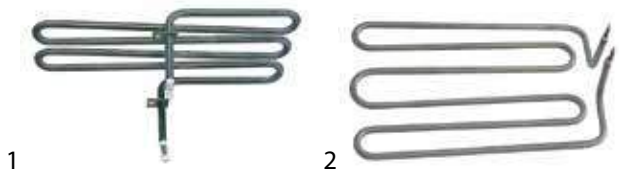

fig.	Vare nr.	P (W)	volt. (V)	L (mm)	W (mm)	H (mm)	Ref. No.
1	415077	1300	230	280	150	40	Y00100
2	416045	3400	230	313	195	82	X48100



fig.	Vare nr.	P (W)	volt. (V)	L (mm)	W (mm)	H (mm)	Ref. No.
3	417344	4700	230	540	210	60	Y10500

Therma

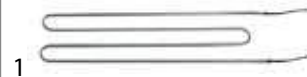

fig.	Vare nr.	P (W)	volt. (V)	L (mm)	W (mm)	H (mm)	Ref. No.
1	415355	2500	230	612	130	8.5	OK4810

Thielmann



fig.	Vare nr.	P (W)	volt. (V)	L (mm)	W (mm)	H (mm)	Ref. No.
1	415594	2565	400	556	126	33	143648

Zanussi



fig.	Vare nr.	P (W)	volt. (V)	L (mm)	W (mm)	H (mm)	Ref. No.
1	415381	1300	220	535	82	100	051355
2	415273	1500	220	373	82	78	058345



fig.	Vare nr.	P (W)	volt. (V)	L (mm)	W (mm)	H (mm)	Ref. No.
3	418016	1500	230	375	76	75	002559
4	418005	2500	400	545	80	48	OC0685

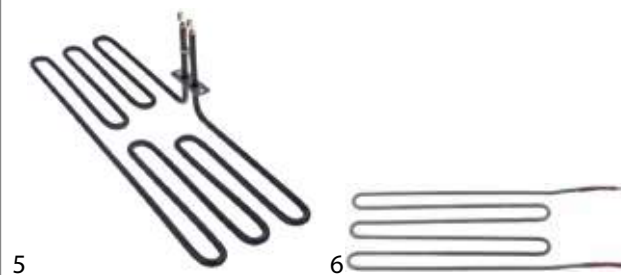

fig.	Vare nr.	P (W)	volt. (V)	L (mm)	W (mm)	H (mm)	Ref. No.
5	418003	3000	230	137	515	48	004469
5	420131	3500	230	145	623	50	OC2613
6	420128	3000	230	500	165	48	OK4745



heating elements for contact grills

Anitec



fig.	Vare nr.	P (W)	volt. (V)	L (mm)	W (mm)	H (mm)	Ref. No.
1	416722	750	230	175	212	22	RG.D02140

Aristarco



fig.	Vare nr.	P (W)	volt. (V)	L (mm)	W (mm)	H (mm)	Ref. No.
1	415726	750	230	180	170	18	00001597
1	415727	900	230	180	175	15	00001598

Bartscher

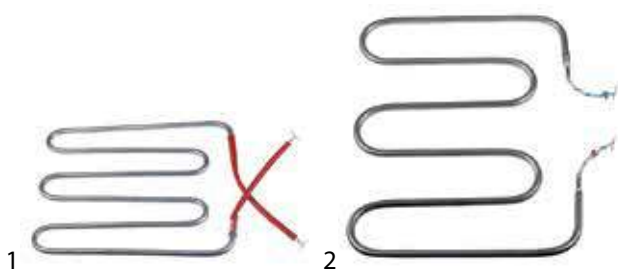

fig.	Vare nr.	P (W)	volt. (V)	L (mm)	W (mm)	H (mm)	Ref. No.
1	416849	800	230	170	167	33	030008013
1	416854	900	230	210	170	20	030008014
1	416859	900	230	210	180	6.3	A010418
1	416853	1100	230	210	250	6.3	A010416
2	416844	900	230	185	247	6.3	A010415

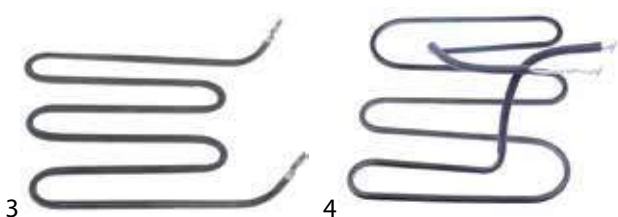

fig.	Vare nr.	P (W)	volt. (V)	L (mm)	W (mm)	H (mm)	Ref. No.
3	419013	1000	230	178	180	40	A039855
4	416845	1100	230	208	220	25	A017607

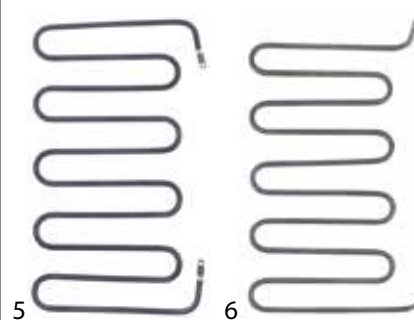

fig.	Vare nr.	P (W)	volt. (V)	L (mm)	W (mm)	H (mm)	Ref. No.
5	419002	1400	230	175	305	20	A041537
6	419003	1550	240	175	305	40	A041538

Bertos



fig.	Vare nr.	P (W)	volt. (V)	L (mm)	W (mm)	H (mm)	Ref. No.
1	416012	700	230	185	187	11	30022500
2	416011	1000	230	182	195	12	30023500

CF-Cenedese

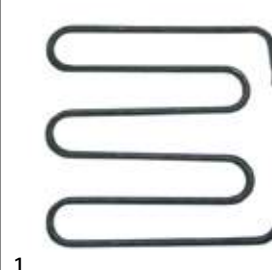

fig.	Vare nr.	P (W)	volt. (V)	L (mm)	W (mm)	H (mm)	Ref. No.
1	415726	750	230	180	170	18	63.7.1012
1	415727	900	230	180	175	15	63.7.1011

Cookmax



fig.	Vare nr.	P (W)	volt. (V)	L (mm)	W (mm)	H (mm)	Ref. No.
1	418660	1200	230	177	215	20	401031200
1	418664	1800	230	185	205	20	401031800



Dihr



fig.	Vare nr.	P (W)	volt. (V)	L (mm)	W (mm)	H (mm)	Ref. No.
1	416197	800	230	180	180	20	DW9716
1	416198	1000	230	180	180	20	DW9717
2	416176	1000	230	180	180	18	DW9561
2	416177	1200	230	180	220	20	DW9562

EGO



fig.	Vare nr.	P (W)	volt. (V)	L (mm)	W (mm)	H (mm)	Ref. No.
1	416496	700	230	176	190	17	24.10083.620

Electrolux



fig.	Vare nr.	P (W)	volt. (V)	L (mm)	W (mm)	H (mm)	Ref. No.
1	415648	660	230	212	72	35	0H9684

Elettrobar



fig.	Vare nr.	P (W)	volt. (V)	L (mm)	W (mm)	H (mm)	Ref. No.
1	416496	700	230	176	190	17	921017
1	416497	1000	230	180	185	15	921008

Faba



fig.	Vare nr.	P (W)	volt. (V)	L (mm)	W (mm)	H (mm)	Ref. No.
1	416145	1000	230	177	180	18	PR10003

Fiamma



fig.	Vare nr.	P (W)	volt. (V)	L (mm)	W (mm)	H (mm)	Ref. No.
1	416585	850	240	200	215	26	4.0.066.0084
2	416586	1150	240	210	230	28	4.0.066.0083



fig.	Vare nr.	P (W)	volt. (V)	L (mm)	W (mm)	H (mm)	Ref. No.
3	418838	1350	240	200	300	26	4.0.069.0050

Fimar

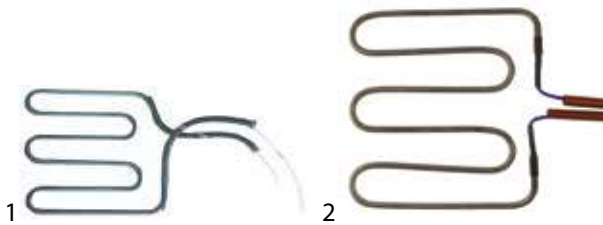

fig.	Vare nr.	P (W)	volt. (V)	L (mm)	W (mm)	H (mm)	Ref. No.
1	416012	700	230	185	187	11	CO4410
2	416011	1000	230	182	195	12	CO4415



Forved

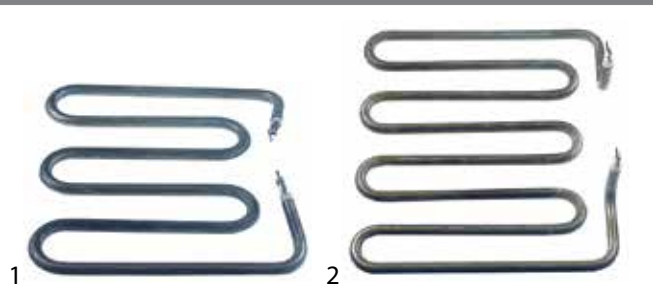

fig.	Vare nr.	P (W)	volt. (V)	L (mm)	W (mm)	H (mm)	Ref. No.
1	416877	1000	230	180	192	18	GRILLRES02
2	416878	1400	230	198	220	46	GRILLRES01

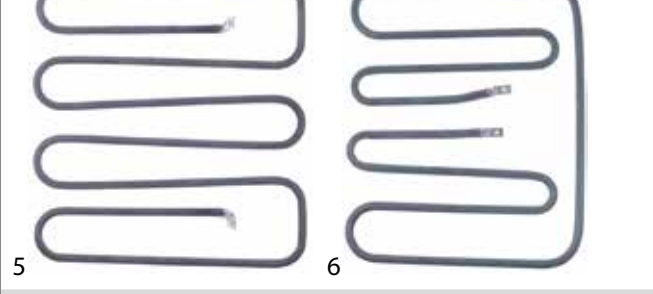

fig.	Vare nr.	P (W)	volt. (V)	L (mm)	W (mm)	H (mm)	Ref. No.
5	420263	1100	230	207	219	34	WF-B107
6	420253	1500	220	225	278	37	KL-053



fig.	Vare nr.	P (W)	volt. (V)	L (mm)	W (mm)	H (mm)	Ref. No.
3	416880	1700	230	198	278	40	GRILLRES04

Hendi

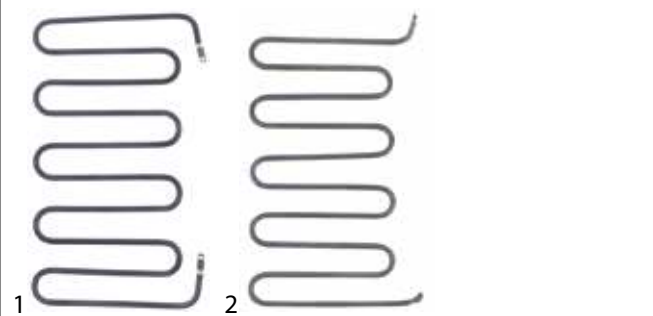

fig.	Vare nr.	P (W)	volt. (V)	L (mm)	W (mm)	H (mm)	Ref. No.
1	419002	1400	230	175	305	20	902028
2	419003	1550	240	175	305	40	902035

GMG

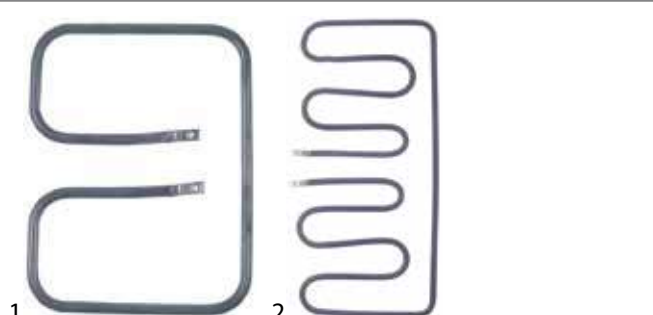

fig.	Vare nr.	P (W)	volt. (V)	L (mm)	W (mm)	H (mm)	Ref. No.
1	420265	650	220	160	210	28	KL-056
2	420252	1000	220	185	395	28	KL-054

King



fig.	Vare nr.	P (W)	volt. (V)	L (mm)	W (mm)	H (mm)	Ref. No.
1	415648	660	230	212	72	35	0H9684



fig.	Vare nr.	P (W)	volt. (V)	L (mm)	W (mm)	H (mm)	Ref. No.
3	420254	1000	220	194	274	37	KL-052
4	420264	1100	230	185	215	41	KL-063

Kromo



fig.	Vare nr.	P (W)	volt. (V)	L (mm)	W (mm)	H (mm)	Ref. No.
1	416197	800	230	180	180	20	DW9716
1	416198	1000	230	180	180	20	DW9717
2	416176	1000	230	180	180	18	DW9561
2	416177	1200	230	180	220	20	DW9562



La-Spaziale



fig.	Vare nr.	P (W)	volt. (V)	L (mm)	W (mm)	H (mm)	Ref. No.
1	416145	1000	230	177	180	18	2987

Repagas



fig.	Vare nr.	P (W)	volt. (V)	L (mm)	W (mm)	H (mm)	Ref. No.
1	420217	1300	230	300	130	55	32400014

RM-Gastro



fig.	Vare nr.	P (W)	volt. (V)	L (mm)	W (mm)	H (mm)	Ref. No.
1	418660	1200	230	177	215	20	401031200
1	418664	1800	230	185	205	20	401031800

Roller Grill

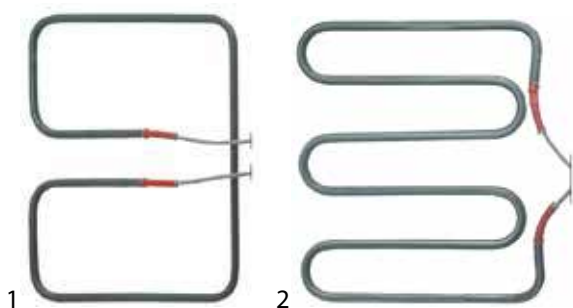

fig.	Vare nr.	P (W)	volt. (V)	L (mm)	W (mm)	H (mm)	Ref. No.
1	416722	750	230	175	212	22	D02140
2	416723	800	230	178	196	33	D02113
2	416724	1200	230	180	200	38	D02095

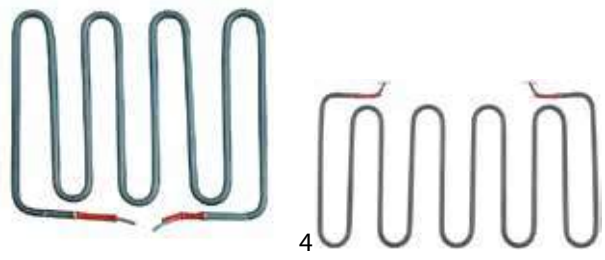

fig.	Vare nr.	P (W)	volt. (V)	L (mm)	W (mm)	H (mm)	Ref. No.
3	416725	1200	240	178	200	35	D02094
3	416701	1800	230	175	208	30	D02093
4	420454	1200	240	180	320	15	D02171

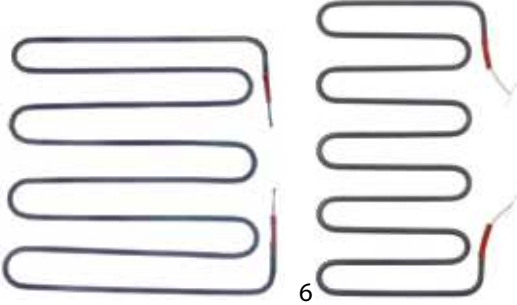

fig.	Vare nr.	P (W)	volt. (V)	L (mm)	W (mm)	H (mm)	Ref. No.
5	417219	1400	230	290	320	8	D02101
6	417537	1800	240	315	180	-	D02170

RSI

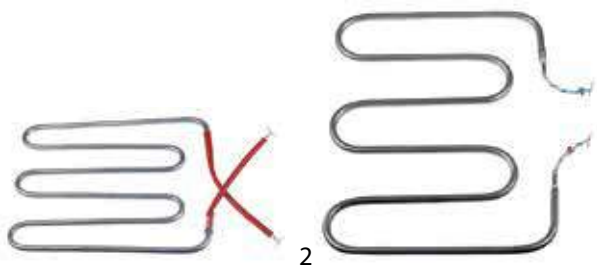

fig.	Vare nr.	P (W)	volt. (V)	L (mm)	W (mm)	H (mm)	Ref. No.
1	416849	800	230	170	167	33	30008013
1	416854	900	230	210	170	20	30008014
1	416853	1100	230	210	250	6.3	30008015
2	416844	900	230	185	247	6.3	30008010



fig.	Vare nr.	P (W)	volt. (V)	L (mm)	W (mm)	H (mm)	Ref. No.
3	416845	1100	230	208	220	25	30008059



Silanos

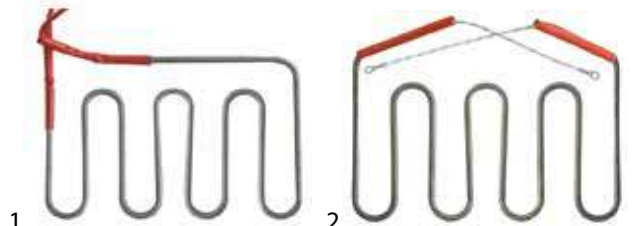

fig.	Vare nr.	P (W)	volt. (V)	L (mm)	W (mm)	H (mm)	Ref. No.
1	416181	1200	230	172	270	11	905615
2	416182	1400	230	180	280	55	905635

Star10



fig.	Vare nr.	P (W)	volt. (V)	L (mm)	W (mm)	H (mm)	Ref. No.
1	416722	750	230	175	212	22	RG.D02140

Silex



fig.	Vare nr.	P (W)	volt. (V)	L (mm)	W (mm)	H (mm)	Ref. No.
1	419047	1350	230	266	146	8.3	05 120 640
1	419048	1650	230	266	145	8.5	05 120 650

heating elements for microwaves

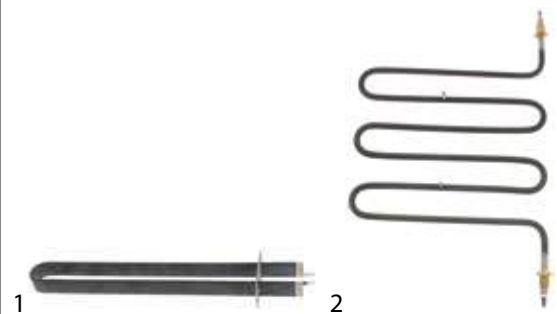

fig.	Vare nr.	P (W)	volt. (V)	L (mm)	W (mm)	FL (mm)	FW (mm)	HD (mm)	suitable for	Ref. No.
1	419193	2000	208	330	25	82	45	67	ACP	59002125
2	419199	3000	208	415	320	-	-	-	ACP	12002874

Sirman



fig.	Vare nr.	P (W)	volt. (V)	L (mm)	W (mm)	H (mm)	Ref. No.
1	416593	700	240	180	175	15	IGS402P
2	416592	850	240	182	175	21	IGS407P

heating elements for pasta cookers

Ambach



fig.	Vare nr.	P (W)	volt. (V)	L (mm)	W (mm)	Ref. No.
1	416959	8000	230	485	33	5060814407



fig.	Vare nr.	P (W)	volt. (V)	L (mm)	W (mm)	H (mm)	Ref. No.
3	416591	875	230	190	308	18	IGS402C

Angelo-Po



fig.	Vare nr.	P (W)	volt. (V)	L (mm)	W (mm)	Ref. No.
1	418602	4500	400	315	36	32G3270
2	415182	4540	230	323	36	32G1300



fig.	Vare nr.	P (W)	volt. (V)	L (mm)	W (mm)	Ref. No.
3	416681	6000	400	485	37	32G2310



Baron



fig.	Vare nr.	P (W)	volt. (V)	L (mm)	W (mm)	Ref. No.
1	418032	2000	240	280	75	BN4185326002063
2	415977	5670	230	292	225	MA1870000

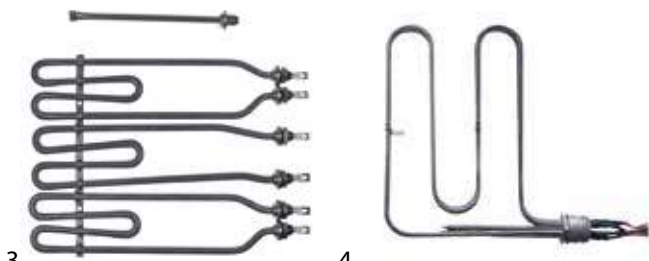

fig.	Vare nr.	P (W)	volt. (V)	L (mm)	W (mm)	Ref. No.
3	416795	7500	230	300	237	BN8218100
4	415971	9000	230/415	245	320	MA1870100

Bertos

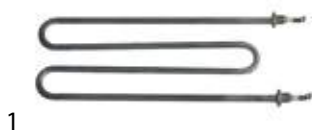

fig.	Vare nr.	P (W)	volt. (V)	L (mm)	W (mm)	Ref. No.
1	415902	2510	230	295	115	22015900

Bourgeois



fig.	Vare nr.	P (W)	volt. (V)	L (mm)	W (mm)	Ref. No.
1	420187	2000	230	405	46	RC3009

Cookmax



fig.	Vare nr.	P (W)	volt. (V)	L (mm)	W (mm)	Ref. No.
1	418663	3000	230	245	225	401002600
2	416795	7500	230	300	237	8218100

Electrolux

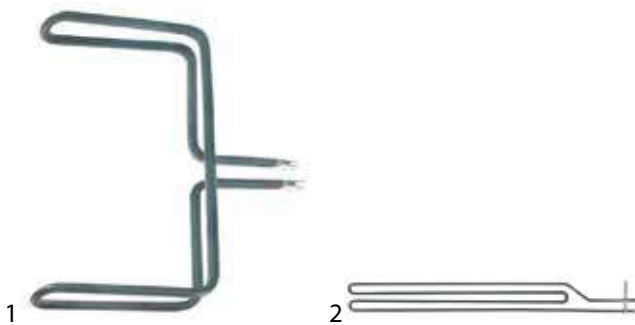

fig.	Vare nr.	P (W)	volt. (V)	L (mm)	W (mm)	Ref. No.
1	416981	1000	230	245	290	0A5492
2	415691	1450	220	507	58	056906

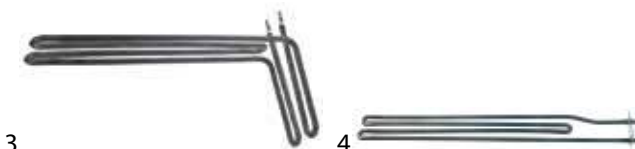

fig.	Vare nr.	P (W)	volt. (V)	L (mm)	W (mm)	Ref. No.
3	416629	1600	230	368	70	005816
4	416980	1650	230	500	54	006853

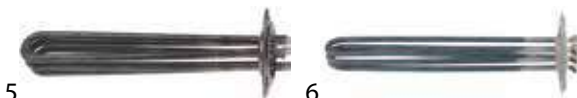

fig.	Vare nr.	P (W)	volt. (V)	L (mm)	W (mm)	Ref. No.
5	420079	3000	230	255	33	0C1848
6	415597	3000	230	255	38	0C5347

Emmepi



fig.	Vare nr.	P (W)	volt. (V)	L (mm)	W (mm)	Ref. No.
1	416071	800	230	350	87	809070
2	416066	1840	230	275	64	808056
2	418032	2000	240	280	75	808056
2	416077	2520/3000	220/240	445	66	808756

Fagor



fig.	Vare nr.	P (W)	volt. (V)	L (mm)	W (mm)	Ref. No.
1	418799	4000	230	348	65	12024715



Gico

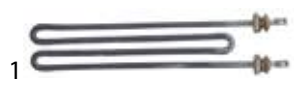

fig.	Vare nr.	P (W)	volt. (V)	L (mm)	W (mm)	Ref. No.
1	416137	2700	230	300	67	270204220

GIGA

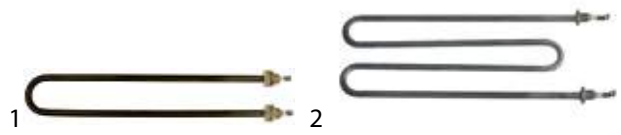

fig.	Vare nr.	P (W)	volt. (V)	L (mm)	W (mm)	Ref. No.
1	418651	1500	230	300	51	Y19800
2	415902	2510	230	295	115	X47100

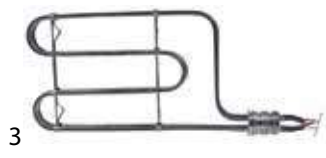

fig.	Vare nr.	P (W)	volt. (V)	L (mm)	W (mm)	Ref. No.
3	416989	4500	230/400	357	200	Y00900

Giorik



fig.	Vare nr.	P (W)	volt. (V)	L (mm)	W (mm)	Ref. No.
1	418032	2000	240	280	75	6002063
1	416077	2520/3000	220/240	445	66	6002064

Ilsa



fig.	Vare nr.	P (W)	volt. (V)	L (mm)	W (mm)	Ref. No.
1	416670	1800	230	315	-	R241050

Juno



fig.	Vare nr.	P (W)	volt. (V)	L (mm)	W (mm)	Ref. No.
1	415597	3000	230	255	38	0C5347

Küppersbusch



fig.	Vare nr.	P (W)	volt. (V)	L (mm)	W (mm)	Ref. No.
1	416910	8000	230/400	300	185	540558

Lincar



fig.	Vare nr.	P (W)	volt. (V)	L (mm)	W (mm)	Ref. No.
1	419214	1840	230	277	60	38000207
2	418032	2000	240	280	75	38000234

Lotus

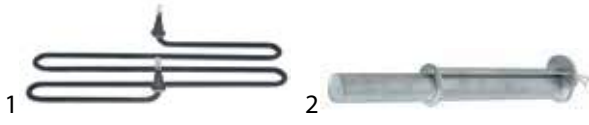

fig.	Vare nr.	P (W)	volt. (V)	L (mm)	W (mm)	Ref. No.
1	415700	1300	230	280	110	—
1	415701	2000	230	276	140	537004900
2	416522	2000	230	300	55	537021200

Mareno



fig.	Vare nr.	P (W)	volt. (V)	L (mm)	W (mm)	Ref. No.
1	420096	5600	230	255	210	CR0731030
2	415977	5670	230	292	225	MA1870000R
2	415991	8499	230	405	225	MA1869900R



fig.	Vare nr.	P (W)	volt. (V)	L (mm)	W (mm)	Ref. No.
3	415971	9000	230/415	245	320	MA1870100R



MBM-Italia



fig.	Vare nr.	P (W)	volt. (V)	L (mm)	W (mm)	Ref. No.
1	416552	1850	230	284	48	RTCU700283
2	416551	3000	230	264	58	RTCU700284



fig.	Vare nr.	P (W)	volt. (V)	L (mm)	W (mm)	Ref. No.
3	416553	3000	230	440	50	RTCU800342

Modular



fig.	Vare nr.	P (W)	volt. (V)	L (mm)	W (mm)	Ref. No.
1	416535	3000	230	303	170	66503200
2	418046	3800	230	250	41	66507400

Multi

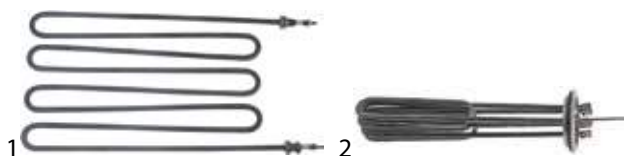

fig.	Vare nr.	P (W)	volt. (V)	L (mm)	W (mm)	Ref. No.
1	416535	3000	230	303	170	665032
2	418046	3800	230	250	41	465000

Offcar



fig.	Vare nr.	P (W)	volt. (V)	L (mm)	W (mm)	Ref. No.
1	416670	1800	230	315	-	443655

Olis

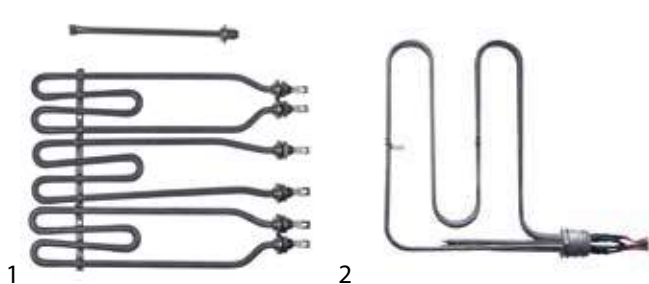

fig.	Vare nr.	P (W)	volt. (V)	L (mm)	W (mm)	Ref. No.
1	416795	7500	230	300	237	BN8218100
2	415971	9000	230/415	245	320	MA1870100R

Palux



fig.	Vare nr.	P (W)	volt. (V)	L (mm)	W (mm)	Ref. No.
1	416909	6000	230/400	300	185	257001
2	416910	8000	230/400	300	185	602051

Pitco

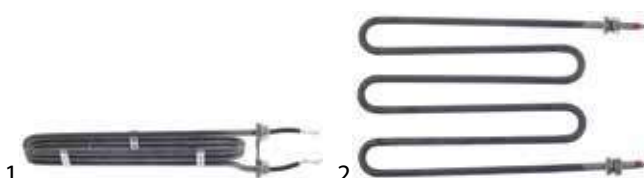

fig.	Vare nr.	P (W)	volt. (V)	L (mm)	W (mm)	Ref. No.
1	420426	2500	230	310	75	B5309305
2	420422	6000	240	345	218	P5046968



fig.	Vare nr.	P (W)	volt. (V)	L (mm)	W (mm)	Ref. No.
3	420429	8500	230	420	275	PP11210

RM-Gastro



fig.	Vare nr.	P (W)	volt. (V)	L (mm)	W (mm)	Ref. No.
1	418663	3000	230	245	225	401002600

Roller Grill

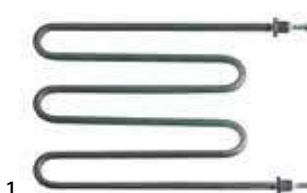



fig.	Vare nr.	P (W)	volt. (V)	L (mm)	W (mm)	Ref. No.
1	416728	2200	230	265	195	D02084



Rosinox



1

fig.	Vare nr.	P (W)	volt. (V)	L (mm)	W (mm)	Ref. No.
1	415977	5670	230	292	225	RX94812607

Silko



1 2

fig.	Vare nr.	P (W)	volt. (V)	L (mm)	W (mm)	Ref. No.
1	415902	2510	230	295	115	SIR0109035
2	420096	5600	230	255	210	CR0731030R

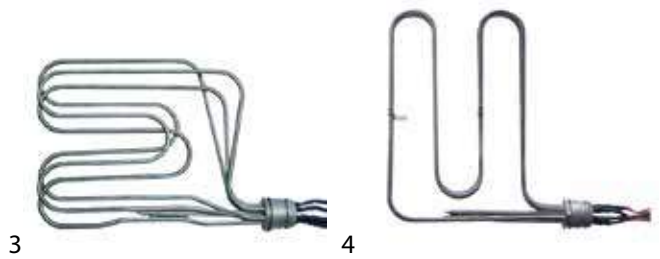

3 4

fig.	Vare nr.	P (W)	volt. (V)	L (mm)	W (mm)	Ref. No.
3	415977	5670	230	292	225	SIR0105199
3	415991	8499	230	405	225	SIR0105168
4	415971	9000	230/415	245	320	MA1870100R

Solymac



1

fig.	Vare nr.	P (W)	volt. (V)	L (mm)	W (mm)	Ref. No.
1	420187	2000	230	405	46	P34B

Star10

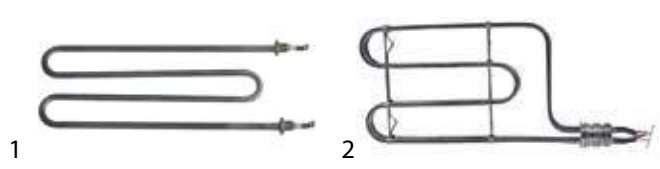

1 2

fig.	Vare nr.	P (W)	volt. (V)	L (mm)	W (mm)	Ref. No.
1	415902	2510	230	295	115	X47100
2	416989	4500	230/400	357	200	Y00900

Tecnoinox



1

fig.	Vare nr.	P (W)	volt. (V)	L (mm)	W (mm)	Ref. No.
1	416629	1600	230	368	70	RC01250000

Zanussi

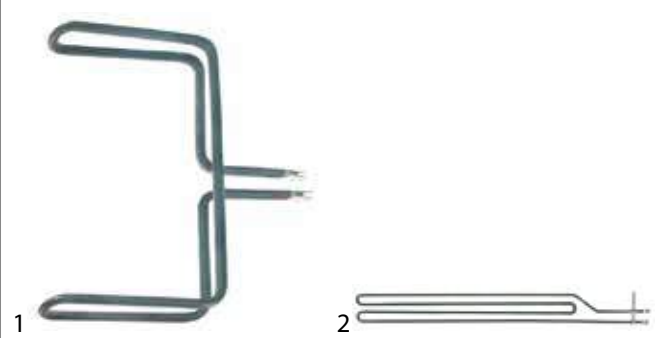

1 2

fig.	Vare nr.	P (W)	volt. (V)	L (mm)	W (mm)	Ref. No.
1	416981	1000	230	245	290	0A5492
2	415691	1450	220	507	58	056906

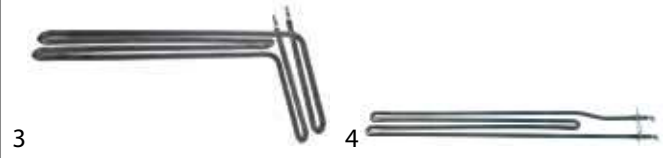

3 4

fig.	Vare nr.	P (W)	volt. (V)	L (mm)	W (mm)	Ref. No.
3	416629	1600	230	368	70	005816
4	416980	1650	230	500	54	006853



5

fig.	Vare nr.	P (W)	volt. (V)	L (mm)	W (mm)	Ref. No.
5	415597	3000	230	255	38	0C5347

heating elements for pizza ovens

Anitec

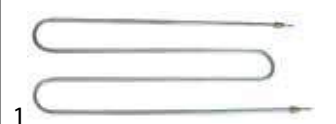

1

fig.	Vare nr.	P (W)	volt. (V)	HC	L (mm)	W (mm)	Ref. No.
1	416162	1000	230	1	582	242	071083



Bartscher



fig.	Vare nr.	P (W)	volt. (V)	HC	L (mm)	W (mm)	Ref. No.
1	418672	1000	230	1	330	300	0401031000

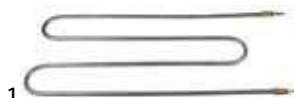

fig.	Vare nr.	P (W)	volt. (V)	HC	L (mm)	W (mm)	Ref. No.
1	416848	800	230	1	445	195	030008062

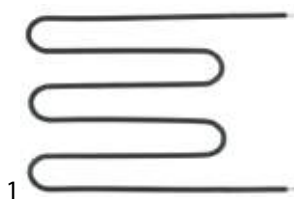

fig.	Vare nr.	P (W)	volt. (V)	HC	L (mm)	W (mm)	Ref. No.
1	418780	600	230	1	300	215	A02011009

Bourgeois

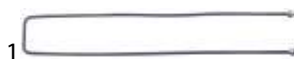

fig.	Vare nr.	P (W)	volt. (V)	HC	L (mm)	W (mm)	Ref. No.
1	420183	1200	230	1	785	120	RC3007

CB



fig.	Vare nr.	P (W)	volt. (V)	HC	L (mm)	W (mm)	Ref. No.
1	419028	1200	230	1	600	232	07030071

CF-Cenedese

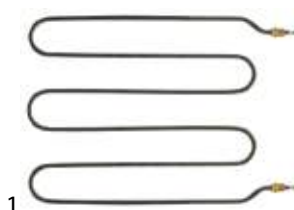

fig.	Vare nr.	P (W)	volt. (V)	HC	L (mm)	W (mm)	Ref. No.
1	416188	800	230	1	365	290	63.7.1088

Cookmax



fig.	Vare nr.	P (W)	volt. (V)	HC	L (mm)	W (mm)	Ref. No.
1	418667	750	230	1	310	250	401021750
2	418672	1000	230	1	330	300	401031000

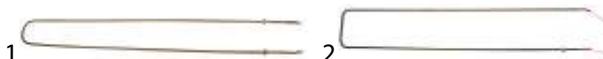

fig.	Vare nr.	P (W)	volt. (V)	HC	L (mm)	W (mm)	Ref. No.
1	418727	920	230	1	1040	120	74400160
1	418728	1650	230	1	1070	130	74400180
2	418725	972	230	1	645	195	74400210
2	418726	1456	230	1			74400260

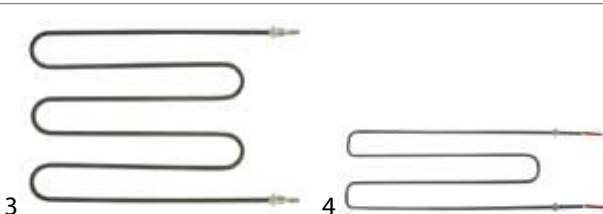

fig.	Vare nr.	P (W)	volt. (V)	HC	L (mm)	W (mm)	Ref. No.
3	416488	1000	230	1	320	240	IB5256400
4	418729	1750	230	1	680	260	74400250

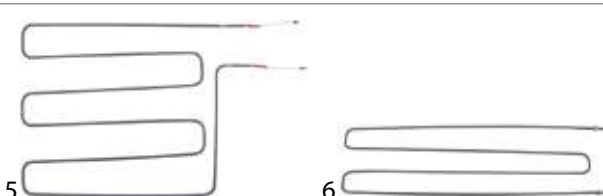

fig.	Vare nr.	P (W)	volt. (V)	HC	L (mm)	W (mm)	Ref. No.
5	418157	2100	230	1	675	550	74400150
6	418730	2400	230	1	1200	290	74400280

Cuppone

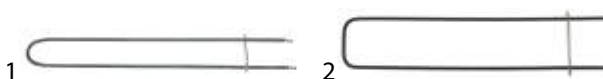

fig.	Vare nr.	P (W)	volt. (V)	HC	L (mm)	W (mm)	Ref. No.
1	415677	600	230	1	567	130	—
1	415916	800	230	1	567	128	—
2	418853	600	230	1	570	130	91711900
2	418854	800	230	1	560	130	91711910





fig.	Vare nr.	P (W)	volt. (V)	HC	L (mm)	W (mm)	Ref. No.
3	415678	1000	230	1	575	160	91711901
3	415917	1400	230	1	572	159	91711911
3	415918	1500	230	1	875	164	91711902
3	415919	2000	230	1	870	160	91711912

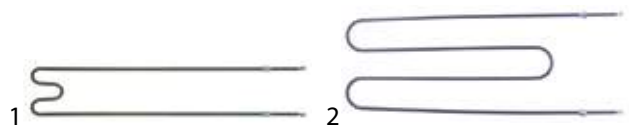

fig.	Vare nr.	P (W)	volt. (V)	HC	L (mm)	W (mm)	Ref. No.
1	416435	600	230	1	605	130	91711020
2	418880	1000	230	1	580	235	91711022

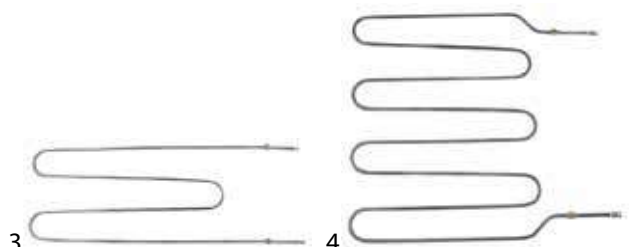

fig.	Vare nr.	P (W)	volt. (V)	HC	L (mm)	W (mm)	Ref. No.
3	418059	1000	230	1	710	300	91711042
4	418053	1500	230	1	365	400	91711005
4	416434	1600	230	1	480	500	91711930

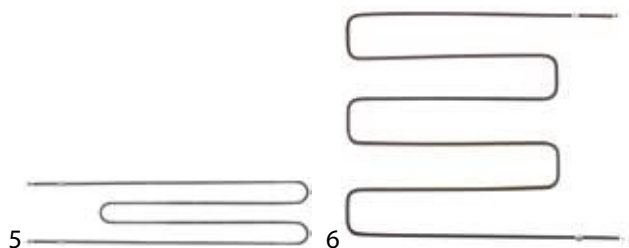

fig.	Vare nr.	P (W)	volt. (V)	HC	L (mm)	W (mm)	Ref. No.
5	416439	1500	230	1	900	245	91711023
6	418675	1800	230	1	575	550	91711011
6	418677	2000	230	1	675	650	91711012
6	418676	2800	230	1	570	520	91711016
6	418678	3200	230	1	675	650	91711017

Electrolux

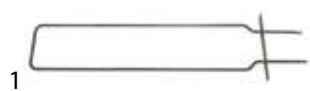

fig.	Vare nr.	P (W)	volt. (V)	HC	L (mm)	W (mm)	Ref. No.
1	415678	1000	230	1	575	160	004151
1	415917	1400	230	1	572	159	004152
1	415918	1500	230	1	875	164	004153
1	415919	2000	230	1	870	160	004154

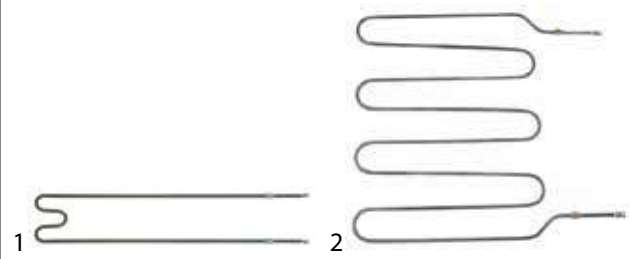

fig.	Vare nr.	P (W)	volt. (V)	HC	L (mm)	W (mm)	Ref. No.
1	416435	600	230	1	605	130	0C3605
2	418053	1500	230	1	365	400	0C6494

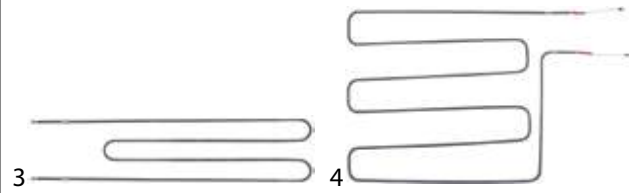

fig.	Vare nr.	P (W)	volt. (V)	HC	L (mm)	W (mm)	Ref. No.
3	416439	1500	230	1	900	245	0C3616
4	418157	2100	230	1	675	550	0KM980

Eloma

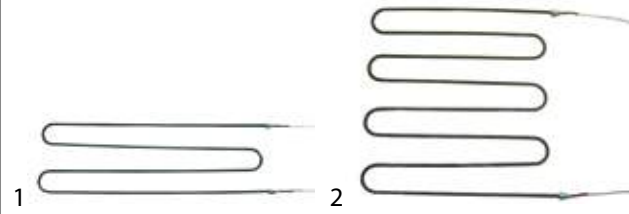

fig.	Vare nr.	P (W)	volt. (V)	HC	L (mm)	W (mm)	Ref. No.
1	415524	1100	230	1	720	200	ELE318052
2	415528	2000	230	1	465	450	ELE318050

Emmepi



fig.	Vare nr.	P (W)	volt. (V)	HC	L (mm)	W (mm)	Ref. No.
1	415917	1400	230	1	572	159	808633

Fage

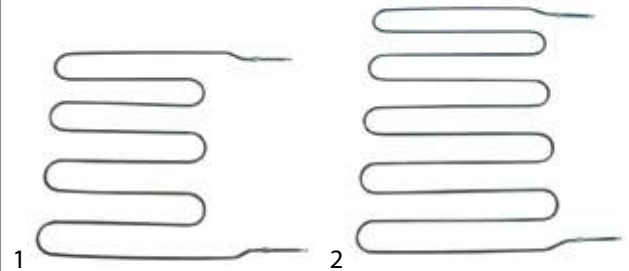

fig.	Vare nr.	P (W)	volt. (V)	HC	L (mm)	W (mm)	Ref. No.
1	415941	2000	230	1	470	506	RES50
1	415942	2280	230	1	600	610	RES62
2	415947	3500	230	1	580	720	RES6292



Fimar

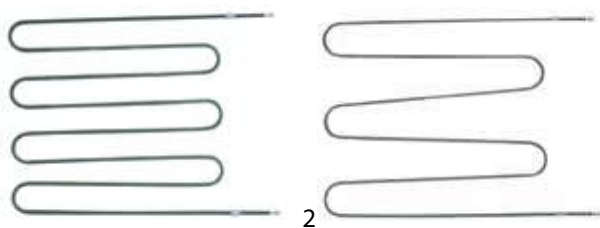

fig.	Vare nr.	P (W)	volt. (V)	HC	L (mm)	W (mm)	Ref. No.
1	416637	2000	230	1	470	420	CO3650
2	416638	2100	230	1	580	460	CO3651

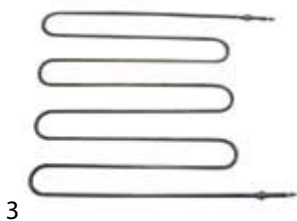

fig.	Vare nr.	P (W)	volt. (V)	HC	L (mm)	W (mm)	Ref. No.
3	416639	3600	230	1	585	800	CO3652

Fornitalia

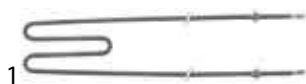

fig.	Vare nr.	P (W)	volt. (V)	HC	L (mm)	W (mm)	Ref. No.
1	419187	1600	230	1	1000	115	K65/105 15

GAM

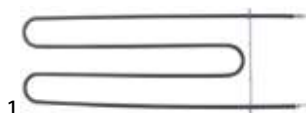

fig.	Vare nr.	P (W)	volt. (V)	HC	L (mm)	W (mm)	Ref. No.
1	419168	1000	230	1	498	195	RG100411
1	420259	1100	230	1	610	250	RG101280

GGF

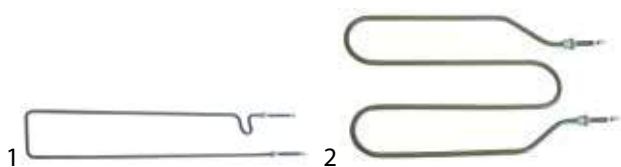

fig.	Vare nr.	P (W)	volt. (V)	HC	L (mm)	W (mm)	Ref. No.
1	416836	1000	230	1	700	142	RESIS008
2	416841	1100	230	1	375	255	RESIS002

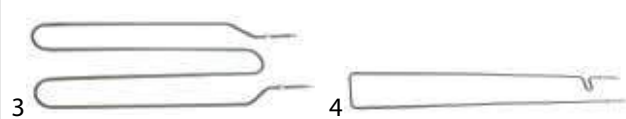

fig.	Vare nr.	P (W)	volt. (V)	HC	L (mm)	W (mm)	Ref. No.
3	416837	1500	230	1	700	270	230V F72-6
4	416839	1500	230	1	1062	141	RESIS010

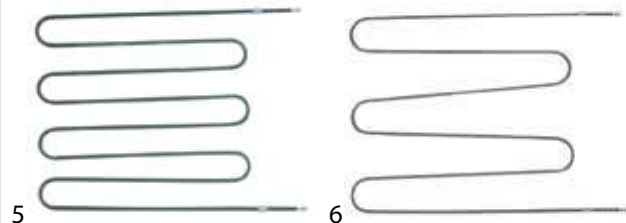

fig.	Vare nr.	P (W)	volt. (V)	HC	L (mm)	W (mm)	Ref. No.
5	416637	2000	230	1	470	420	RESIS001
6	416638	2100	230	1	580	460	P4-E4-P44
6	420041	3000	230	1	690	460	RESIS013

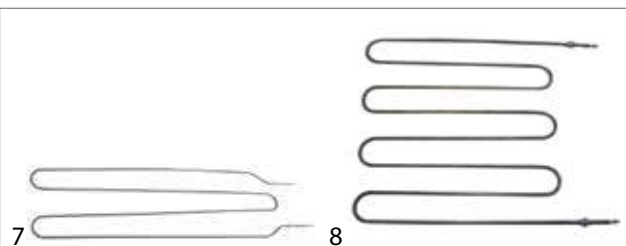

fig.	Vare nr.	P (W)	volt. (V)	HC	L (mm)	W (mm)	Ref. No.
7	416840	2200	230	1	1060	260	res.2200W230V F108-9
8	416639	3600	230	1	585	800	RESIS004

GMG

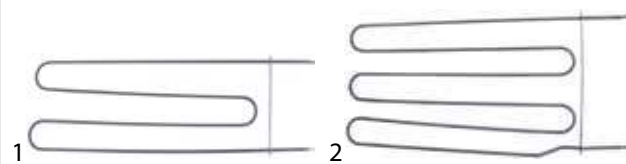

fig.	Vare nr.	P (W)	volt. (V)	HC	L (mm)	W (mm)	Ref. No.
1	420250	1250	220	1	613	218	PI-B116
1	420249	1250	220	1	688	250	PI-B112
2	420251	1500	220	1	610	350	PI-B107

IME Turbo

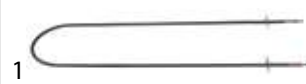

fig.	Vare nr.	P (W)	volt. (V)	HC	L (mm)	W (mm)	Ref. No.
1	415826	1000	230	1	505	142	IME00005007

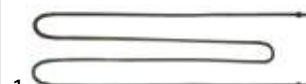



fig.	Vare nr.	P (W)	volt. (V)	HC	L (mm)	W (mm)	Ref. No.
1	415331	1500	230	1	646	300	202011

1

fig.	Vare nr.	P (W)	volt. (V)	HC	L (mm)	W (mm)	Ref. No.
1	415226	750	230	1	405	210	—

Inoksan

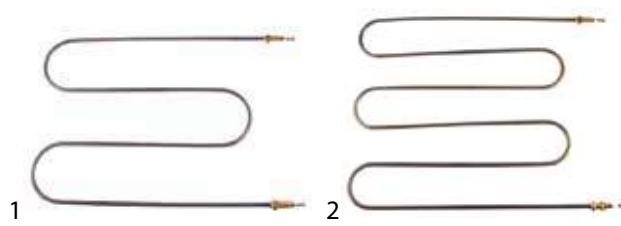

1 2

fig.	Vare nr.	P (W)	volt. (V)	HC	L (mm)	W (mm)	Ref. No.
1	416865	1500	230	1	485	360	22207023
2	416866	2250	230	1	485	410	22207024

Izmak

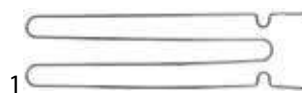

1

fig.	Vare nr.	P (W)	volt. (V)	HC	L (mm)	W (mm)	Ref. No.
1	419122	1500	230	1	890	280	—

Lincoln



1

fig.	Vare nr.	P (W)	volt. (V)	HC	L (mm)	W (mm)	Ref. No.
1	420090	1600	240	1	68	173	369184

Lotus

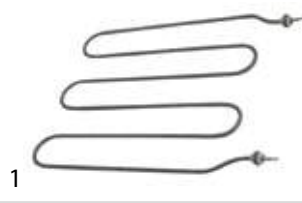

1

fig.	Vare nr.	P (W)	volt. (V)	HC	L (mm)	W (mm)	Ref. No.
1	416644	750	230	1	373	327	537003200

Mareno



1

fig.	Vare nr.	P (W)	volt. (V)	HC	L (mm)	W (mm)	Ref. No.
1	415164	900	240	1	295	88	MA59741

MIWE



1

fig.	Vare nr.	P (W)	volt. (V)	HC	L (mm)	W (mm)	Ref. No.
1	420350	1500	230	1	1295	23	071489.14

Moretti



1

fig.	Vare nr.	P (W)	volt. (V)	HC	L (mm)	W (mm)	Ref. No.
1	416377	700	220	1	610	80	74400720
1	418173	1000	230	1	1236	75	74420540
1	418158	1005	115	1	660	88	74401130
1	418168	1275	115	1	800	94	74420590

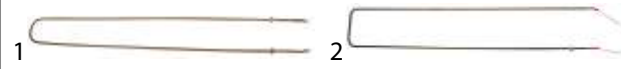

1 2

fig.	Vare nr.	P (W)	volt. (V)	HC	L (mm)	W (mm)	Ref. No.
1	418727	920	230	1	1040	120	74400160
1	418728	1650	230	1	1070	130	74400180
2	418725	972	230	1	645	195	74400210
2	418726	1456	230	1			74400260

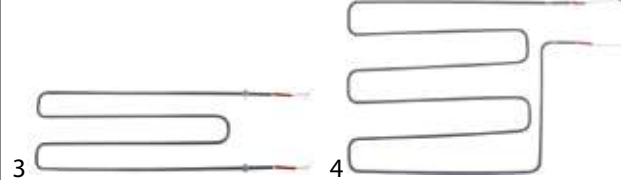

3 4

fig.	Vare nr.	P (W)	volt. (V)	HC	L (mm)	W (mm)	Ref. No.
3	418729	1750	230	1	680	260	74400250
4	418157	2100	230	1	675	550	74400150

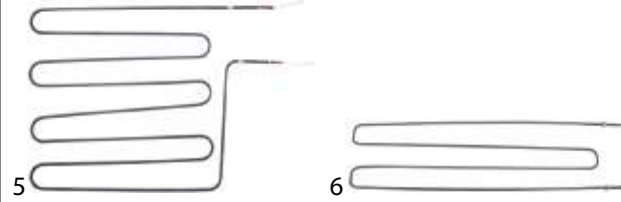

5 6

fig.	Vare nr.	P (W)	volt. (V)	HC	L (mm)	W (mm)	Ref. No.
5	417588	2100	230	1	675	560	74401180
6	418730	2400	230	1	1200	290	74400280



Morice

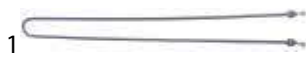

fig.	Vare nr.	P (W)	volt. (V)	HC	L (mm)	W (mm)	Ref. No.
1	420260	400	230	1	640	49	RS0921

Multi

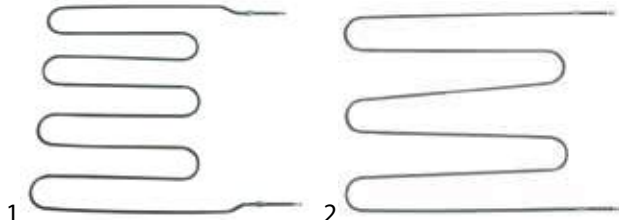

fig.	Vare nr.	P (W)	volt. (V)	HC	L (mm)	W (mm)	Ref. No.
1	415941	2000	230	1	470	506	501001
1	415942	2280	230	1	600	610	501022
2	416638	2100	230	1	580	460	501131

OEM

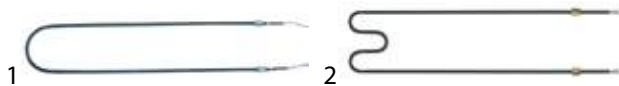

fig.	Vare nr.	P (W)	volt. (V)	HC	L (mm)	W (mm)	Ref. No.
1	415944	700	230	1	580	122	EE13200
1	415946	700	400	1	575	120	EE13400
2	416469	900	230	1	583	167	EE10500
2	416471	900	400	1	580	160	EE10700
2	416470	1100	230	1	580	160	EE10400
2	416472	1100	400	1	580	165	EE10600
2	420435	1300	230	1	568	158	EE24700
2	420436	1300	400	1	570	162	EE12800
2	416475	1300	400	1	880	160	EE11500
2	416476	1600	400	1	880	155	EE11400

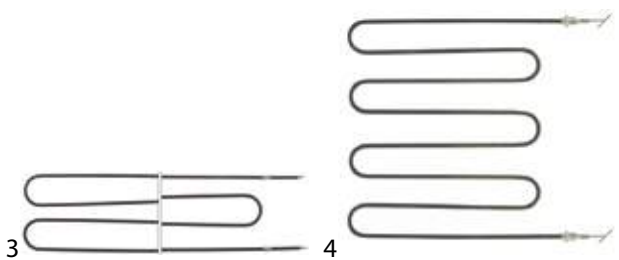

fig.	Vare nr.	P (W)	volt. (V)	HC	L (mm)	W (mm)	Ref. No.
3	417540	1600	230	1	895	200	EE24400
4	416462	1650	230	1	470	450	EE07000

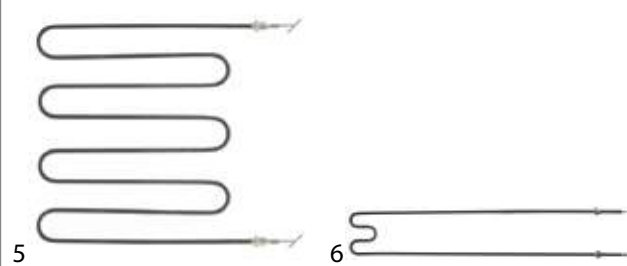

fig.	Vare nr.	P (W)	volt. (V)	HC	L (mm)	W (mm)	Ref. No.
5	416464	2000	230	1	600	572	EE17700
6	418889	2000	230	1	880	160	EE24800

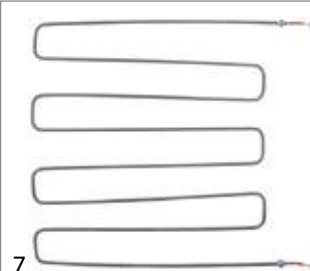

fig.	Vare nr.	P (W)	volt. (V)	HC	L (mm)	W (mm)	Ref. No.
7	420437	3000	230	1	672	657	EE28100

Palux

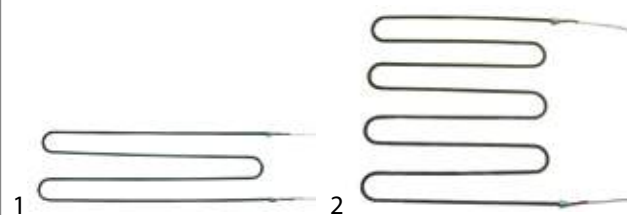

fig.	Vare nr.	P (W)	volt. (V)	HC	L (mm)	W (mm)	Ref. No.
1	415524	1100	230	1	720	200	126551
2	415528	2000	230	1	465	450	126578

Pizza-Group

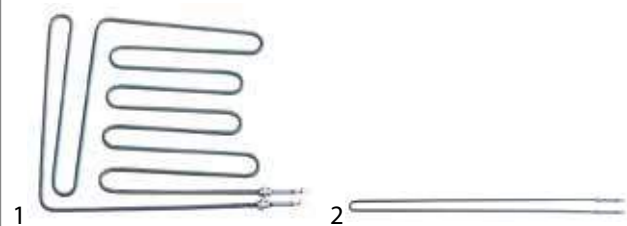

fig.	Vare nr.	P (W)	volt. (V)	HC	L (mm)	W (mm)	Ref. No.
1	416673	500	230	1	315	315	A87RZ80003
2	416571	700	400	1	917	43	A87RZ65044







fig.	Vare nr.	P (W)	volt. (V)	HC	L (mm)	W (mm)	Ref. No.
3	418819	1200	230	1	645	220	A87RZ65046
3	416413	1900	230	1	970	210	A87RZ65051
4	416454	1900	380	1	640	295	A87RZ65049

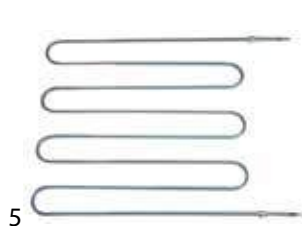



fig.	Vare nr.	P (W)	volt. (V)	HC	L (mm)	W (mm)	Ref. No.
5	416450	2000	380	1	467	433	A87RZ65042
5	416453	2000	400	1	640	510	A87RZ65048
5	418829	2500	230	1	570	490	A87RZ65043
5	416452	2500	400	1	638	470	A87RZ65058
5	419072	2800	230	1	645	550	A87RZ65058
6	416674	2500	230	1	495	480	A87RZ65037

RM-Gastro





fig.	Vare nr.	P (W)	volt. (V)	HC	L (mm)	W (mm)	Ref. No.
1	418667	750	230	1	310	250	401021750
2	418672	1000	230	1	330	300	401031000

RSI

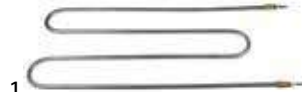

fig.	Vare nr.	P (W)	volt. (V)	HC	L (mm)	W (mm)	Ref. No.
1	416848	800	230	1	445	195	30008062

Sirman

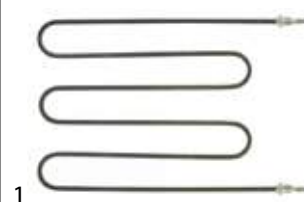

fig.	Vare nr.	P (W)	volt. (V)	HC	L (mm)	W (mm)	Ref. No.
1	416489	700	230	1	316	235	IB5256410
1	416488	1000	230	1	320	240	IB5256400

Solymac

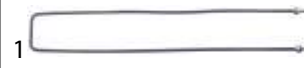

fig.	Vare nr.	P (W)	volt. (V)	HC	L (mm)	W (mm)	Ref. No.
1	420183	1200	230	1	785	120	P33

Tornati





fig.	Vare nr.	P (W)	volt. (V)	HC	L (mm)	W (mm)	Ref. No.
1	415521	650	230	1	570	160	336007
1	415520	1000	230	1	875	182	336011
2	415890	1500	230	1	455	410	336023
2	415891	2000	230	1	560	545	336024

VEGA

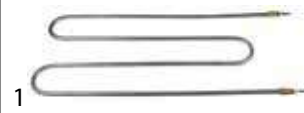

fig.	Vare nr.	P (W)	volt. (V)	HC	L (mm)	W (mm)	Ref. No.
1	416848	800	230	1	445	195	93107

Whirlpool



fig.	Vare nr.	P (W)	volt. (V)	HC	L (mm)	W (mm)	Ref. No.
1	415917	1400	230	1	572	159	104152

Zanelli

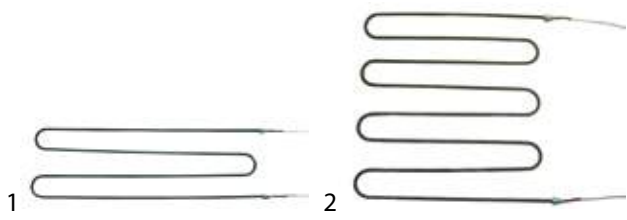

fig.	Vare nr.	P (W)	volt. (V)	HC	L (mm)	W (mm)	Ref. No.
1	415524	1100	230	1	720	200	RESI00211
2	415528	2000	230	1	465	450	—



fig.	Vare nr.	P (W)	volt. (V)	HC	L (mm)	W (mm)	Ref. No.
3	418125	3000	220	1	925	70	RESI0125
4	418122	3300	230	1	230	263	RESI0061
4	418124	4100	230	1	230	248.5	RESI0082

Zanussi

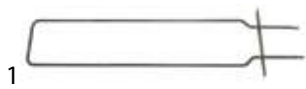

fig.	Vare nr.	P (W)	volt. (V)	HC	L (mm)	W (mm)	Ref. No.
1	415678	1000	230	1	575	160	004151
1	415917	1400	230	1	572	159	004152
1	415919	2000	230	1	870	160	004154

heating elements for pizza presses

Cuppone

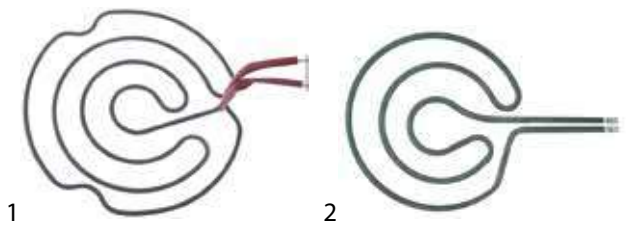

fig.	Vare nr.	P (W)	volt. (V)	HC	L (mm)	W (mm)	Ref. No.
1	419186	208	1790	1	29	-	91711280
1	418047	1600	230	1	300	-	91711080
2	416441	1500	230	1	355	245	91711940

OEM

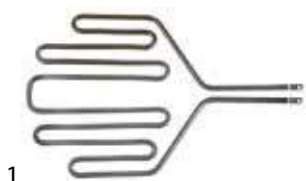

fig.	Vare nr.	P (W)	volt. (V)	HC	L (mm)	W (mm)	Ref. No.
1	416478	1500	400	1	369	235	EE18100

Pizza-Group

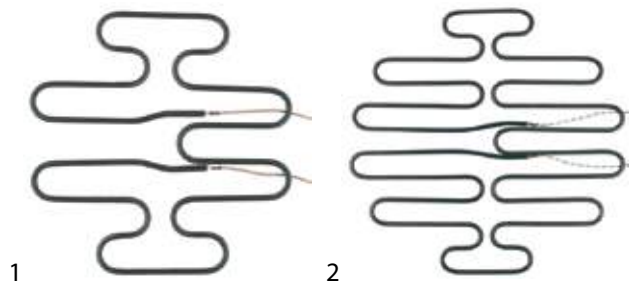

fig.	Vare nr.	P (W)	volt. (V)	HC	L (mm)	W (mm)	Ref. No.
1	416309	2000	230	1	260	260	57110120
2	416316	2500	230	1	360	360	A87RZ66003

heating elements for rechauds

Lükon



fig.	Vare nr.	P (W)	H (mm)	volt. (V)	L (mm)	W (mm)	Ref. No.
1	418500	200	53	230	335	18	5-000973
2	415638	750	56	230	175	260	5-001237
2	415639	1200	56	230	255	256	5-001238

Roller Grill

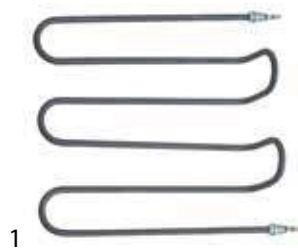

fig.	Vare nr.	P (W)	H (mm)	volt. (V)	L (mm)	W (mm)	Ref. No.
1	416712	1300	82	230	290	258	D02003

VEGA



fig.	Vare nr.	P (W)	H (mm)	volt. (V)	L (mm)	W (mm)	Ref. No.
1	416712	1300	82	230	290	258	für 81133V1



heating elements for rolling grills



fig.	Vare nr.	P (W)	volt. (V)	L (mm)	tube ø (mm)	suitable for	Ref. No.
1	416189	220	240	359	8.5	CB CF-Cenedese Cookmax RM-Gastro	07030052 63.7.1081 637108200 637108200
1	419188	450	230	540	8.5mm	—	—

heating elements for chargrills

Angelo-Po



fig.	Vare nr.	P (W)	volt. (V)	HC	L (mm)	W (mm)	H (mm)	Ref. No.
1	415148	750	230		519	35	105	32G0140

Anitec



fig.	Vare nr.	P (W)	volt. (V)	HC	L (mm)	W (mm)	H (mm)	Ref. No.
1	418231	2300	230	1	457	183	111	071025
2	418232	3100	230	1	440	280	105	071034

Bertos



fig.	Vare nr.	P (W)	volt. (V)	HC	L (mm)	W (mm)	H (mm)	Ref. No.
1	416000	1500	230	1	438	80	62	22039100

EGO



fig.	Vare nr.	P (W)	volt. (V)	HC	L (mm)	W (mm)	H (mm)	Ref. No.
1	415676	400	230	1	465	8.5	8.5	20.25013.000

EKU



fig.	Vare nr.	P (W)	volt. (V)	HC	L (mm)	W (mm)	H (mm)	Ref. No.
1	415095	1500	220	1	465	75	55	1-W-236
2	415250	1650	230	1	490	42	45	4-FI-18

Electrolux



fig.	Vare nr.	P (W)	volt. (V)	HC	L (mm)	W (mm)	H (mm)	Ref. No.
1	416978	2500	400	1	625	90	40	0C0495

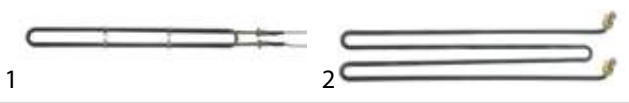

fig.	Vare nr.	P (W)	volt. (V)	HC	L (mm)	W (mm)	H (mm)	Ref. No.
1	415647	1000	230	1	440	30	6.5	0K9752
2	415288	1350	230	1	396	80	37	004907

GGX

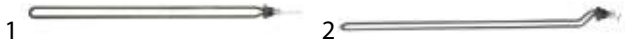

fig.	Vare nr.	P (W)	volt. (V)	HC	L (mm)	W (mm)	H (mm)	Ref. No.
1	415641	450	230	1	497	30	32	345920532
2	415649	600	400	1	490	25	25	345921532

GIGA



fig.	Vare nr.	P (W)	volt. (V)	HC	L (mm)	W (mm)	H (mm)	Ref. No.
1	416000	1500	230	1	438	80	62	Y00200

Haka



fig.	Vare nr.	P (W)	volt. (V)	HC	L (mm)	W (mm)	H (mm)	Ref. No.
1	415633	1500	230	1	452	73	35	9005A

Herzog&Langen



fig.	Vare nr.	P (W)	volt. (V)	HC	L (mm)	W (mm)	H (mm)	Ref. No.
1	415641	450	230	1	497	30	32	345920532
2	415649	600	400	1	490	25	25	345921532

Jünger



fig.	Vare nr.	P (W)	volt. (V)	HC	L (mm)	W (mm)	H (mm)	Ref. No.
1	415343	1500	230	1	300	285	30	421000



King



fig.	Vare nr.	P (W)	volt. (V)	HC	L (mm)	W (mm)	H (mm)	Ref. No.
1	415647	1000	230	1	440	30	6.5	0K9752

Krefft



fig.	Vare nr.	P (W)	volt. (V)	HC	L (mm)	W (mm)	H (mm)	Ref. No.
1	415595	1900	400	1	410	125	28	49-182332



fig.	Vare nr.	P (W)	volt. (V)	HC	L (mm)	W (mm)	H (mm)	Ref. No.
1	415592	2000	230	1	400	142	64	49-182653

Küppersbusch



fig.	Vare nr.	P (W)	volt. (V)	HC	L (mm)	W (mm)	H (mm)	Ref. No.
1	415595	1900	400	1	410	125	28	182332



fig.	Vare nr.	P (W)	volt. (V)	HC	L (mm)	W (mm)	H (mm)	Ref. No.
1	415592	2000	230	1	400	142	64	182653

Lotus

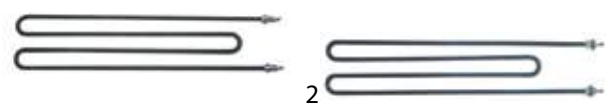

fig.	Vare nr.	P (W)	volt. (V)	HC	L (mm)	W (mm)	H (mm)	Ref. No.
1	415770	2000	230	1	420	80	8.5	537010700
2	416520	2000	230	1	450	95	8.5	537022000

Mareno



fig.	Vare nr.	P (W)	volt. (V)	HC	L (mm)	W (mm)	H (mm)	Ref. No.
1	415095	1500	220	1	465	75	55	MA1037300000
2	415965	1800	230	1	486	83	30	MA1037311315

MBM-Italia



fig.	Vare nr.	P (W)	volt. (V)	HC	L (mm)	W (mm)	H (mm)	Ref. No.
1	416549	1500	230	1	439	79	34	RTCU600153

MKN



fig.	Vare nr.	P (W)	volt. (V)	HC	L (mm)	W (mm)	H (mm)	Ref. No.
1	415522	800	380	1	480	68	74	574091
2	415427	820	95	1	504	33	105	574027



fig.	Vare nr.	P (W)	volt. (V)	HC	L (mm)	W (mm)	H (mm)	Ref. No.
3	415426	870	95	1	495	35	73	574097

Nayati



fig.	Vare nr.	P (W)	volt. (V)	HC	L (mm)	W (mm)	H (mm)	Ref. No.
1	418428	1600	230	1	471	118	94	PD411T

Palux

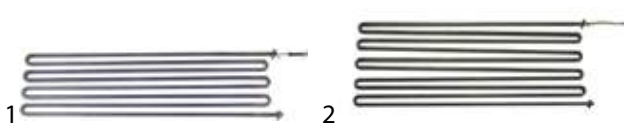

fig.	Vare nr.	P (W)	volt. (V)	HC	L (mm)	W (mm)	H (mm)	Ref. No.
1	415398	1280	230	1	440	112	28	649473
2	415399	1600	230	1	440	145	28	649481

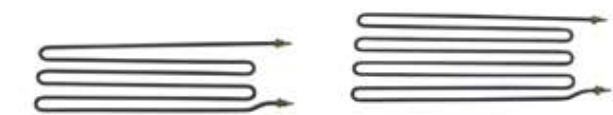

fig.	Vare nr.	P (W)	volt. (V)	HC	L (mm)	W (mm)	H (mm)	Ref. No.
1	415358	2250	230	1	485	135	8.5	—
2	415359	3000	230	1	473	170	8.5	—



Roka



fig.	Vare nr.	P (W)	volt. (V)	HC	L (mm)	W (mm)	H (mm)	Ref. No.
1	415676	400	230	1	465	8.5	8.5	8900326

Zanussi



fig.	Vare nr.	P (W)	volt. (V)	HC	L (mm)	W (mm)	H (mm)	Ref. No.
1	416978	2500	400	1	625	90	40	0C0495

Rosinox



fig.	Vare nr.	P (W)	volt. (V)	HC	L (mm)	W (mm)	H (mm)	Ref. No.
1	415250	1650	230	1	490	42	45	RX94800224



fig.	Vare nr.	P (W)	volt. (V)	HC	L (mm)	W (mm)	H (mm)	Ref. No.
1	415288	1350	230	1	396	80	37	004907

heating elements for salamanders/toasters

Silko



fig.	Vare nr.	P (W)	volt. (V)	HC	L (mm)	W (mm)	H (mm)	Ref. No.
1	415250	1650	230	1	490	42	45	SIR0101527

963foodtech



fig.	Vare nr.	P (W)	volt. (V)	HC	L (mm)	W (mm)	H (mm)	Ref. No.
1	420301	500	240	1	250	55	-	2016024

Star10



fig.	Vare nr.	P (W)	volt. (V)	HC	L (mm)	W (mm)	H (mm)	Ref. No.
1	418231	2300	230	1	457	183	111	071025
2	418232	3100	230	1	440	280	105	071034

Aliberinox

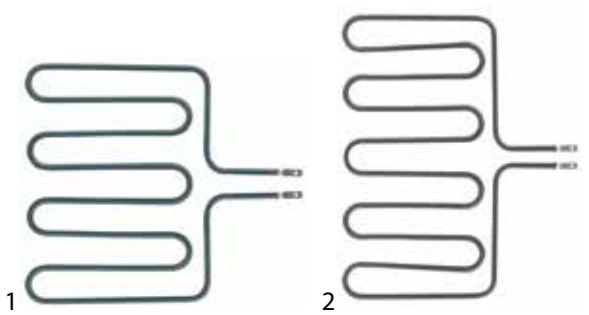

fig.	Vare nr.	P (W)	volt. (V)	HC	L (mm)	W (mm)	H (mm)	Ref. No.
1	416579	1900	220	1	245	240	6.3	417522300
1	420288	1900	400	1	245	240	6.5	417522400
2	416580	2000	220	1	240	333	6.3	417522200



fig.	Vare nr.	P (W)	volt. (V)	HC	L (mm)	W (mm)	H (mm)	Ref. No.
1	416000	1500	230	1	438	80	62	Y00200

Tecnoinox

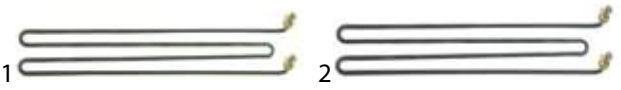

fig.	Vare nr.	P (W)	volt. (V)	HC	L (mm)	W (mm)	H (mm)	Ref. No.
1	416601	1000	230	1	396	65	35	RC00775000
2	415288	1350	230	1	396	80	37	RC00513000
2	416618	1350	230	1	450	76	36	RC01111000

Ambach

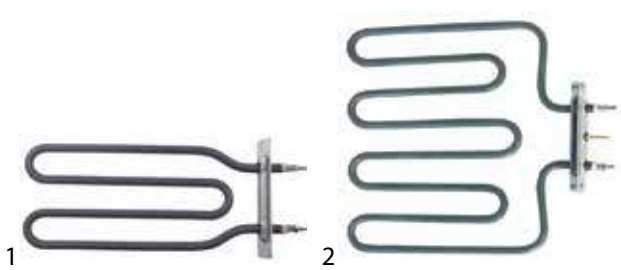

fig.	Vare nr.	P (W)	volt. (V)	HC	L (mm)	W (mm)	H (mm)	Ref. No.
1	420271	1000	230	1	215	95	8.5	6205403708
2	416654	2000	230	1	230	230	8.5	6205403706

Ubert



fig.	Vare nr.	P (W)	volt. (V)	HC	L (mm)	W (mm)	H (mm)	Ref. No.
1	416913	5200	230	4	437	120	8.5	343131



Angelo-Po

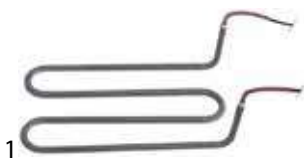

fig.	Vare nr.	P (W)	volt. (V)	HC	L (mm)	W (mm)	H (mm)	Ref. No.
1	415758	1300	230	1	238	132	72	32G1441

Anitec



fig.	Vare nr.	P (W)	volt. (V)	HC	L (mm)	W (mm)	H (mm)	Ref. No.
1	416155	2000	230	1	197	263	8.5	071019
1	416154	2500	230	1	368	255	8.5	071018

Aristarco

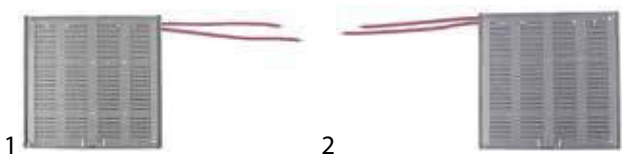

fig.	Vare nr.	P (W)	volt. (V)	HC	L (mm)	W (mm)	H (mm)	Ref. No.
1	417536	400	120		145	150	5	00001104 SX
2	416037	400	120	1	145	150	5	00001104 DX

Baron



fig.	Vare nr.	P (W)	volt. (V)	HC	L (mm)	W (mm)	H (mm)	Ref. No.
1	416654	2000	230	1	230	230	8.5	BN0111641850

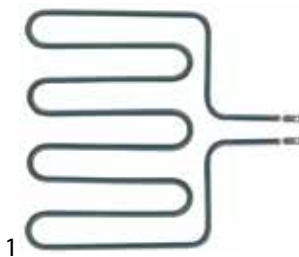

fig.	Vare nr.	P (W)	volt. (V)	HC	L (mm)	W (mm)	H (mm)	Ref. No.
1	420288	1900	400	1	245	240	6.5	BN011LIN1400011

Bartscher

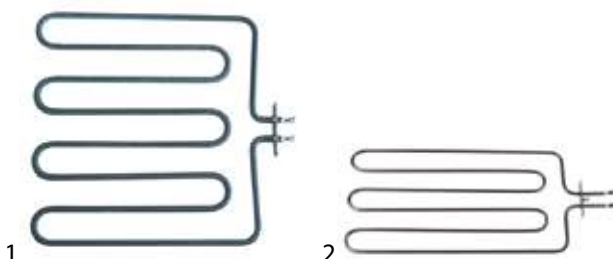

fig.	Vare nr.	P (W)	volt. (V)	HC	L (mm)	W (mm)	H (mm)	Ref. No.
1	415659	2000	230	1	230	303	8.5	011029
1	415660	2800	230	1	230	298	8.5	011003
2	418740	2000	230	1	400	200	6.5	A0AT93607

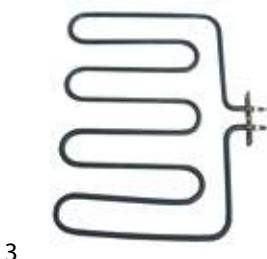

fig.	Vare nr.	P (W)	volt. (V)	HC	L (mm)	W (mm)	H (mm)	Ref. No.
3	418790	2800	400	1	305	300	8.5	011008

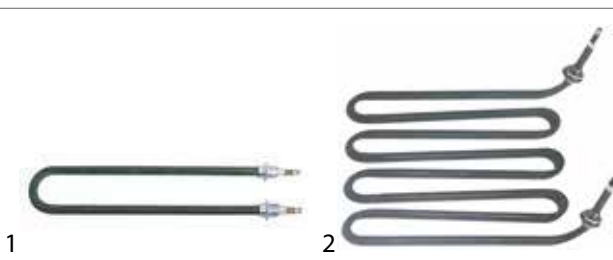

fig.	Vare nr.	P (W)	volt. (V)	HC	L (mm)	W (mm)	H (mm)	Ref. No.
1	416820	930	230	1	260	55	10	6001071
2	418862	2000	230	1	235	215	35	0V036700



fig.	Vare nr.	P (W)	volt. (V)	HC	L (mm)	W (mm)	H (mm)	Ref. No.
3	418653	2200	230	1	350	260	8.5	0401024000
4	420046	2800	230	1	240	350	25	A039856

fig.	Vare nr.	P (W)	volt. (V)	HC	L (mm)	W (mm)	H (mm)	Ref. No.
1	416001	1500	230	1	265	165	50	027676

Bertos

fig.	Vare nr.	P (W)	volt. (V)	HC	L (mm)	W (mm)	H (mm)	Ref. No.
1	415347	1600	230	1	295	205	45	27022300
1	416009	2300	230	1	300	205	40	27023000

fig.	Vare nr.	P (W)	volt. (V)	HC	L (mm)	W (mm)	H (mm)	Ref. No.
1	416833	2800	230	1	206	398	6.3	27022100

CF-Cenedese

fig.	Vare nr.	P (W)	volt. (V)	HC	L (mm)	W (mm)	H (mm)	Ref. No.
1	415723	1900	230	1	305	260	6.3	63.7.1022

fig.	Vare nr.	P (W)	volt. (V)	HC	L (mm)	W (mm)	H (mm)	Ref. No.
1	415697	800	230	1	225	135	6.3	63.7.1092
1	415698	1000	230	1	330	140	6.3	63.7.1093
2	415694	2000	230	1	350	205	6.3	63.7.1084

Cookmax

fig.	Vare nr.	P (W)	volt. (V)	HC	L (mm)	W (mm)	H (mm)	Ref. No.
1	418722	600	220	1	210	90	40	X02.09.259.00
1	418721	700	220	1	210	85	40	X02.09.258.00
1	418724	900	220	1	290	110	40	X02.09.261.00
1	418723	1000	220	1	290	90	40	X02.09.260.00

fig.	Vare nr.	P (W)	volt. (V)	HC	L (mm)	W (mm)	H (mm)	Ref. No.
1	418740	2000	230	1	400	200	6.5	A0AT93607

fig.	Vare nr.	P (W)	volt. (V)	HC	L (mm)	W (mm)	H (mm)	Ref. No.
1	418645	1700	230	1	235	211	6.3	1B52565010
2	418653	2200	230	1	350	260	8.5	401024000



Dihr



fig.	Vare nr.	P (W)	volt. (V)	HC	L (mm)	W (mm)	H (mm)	Ref. No.
1	416647	2000	230	1	225	208	8.5	DW9153
1	416646	2000	230	1	290	216	8.5	DW9113

EGO



fig.	Vare nr.	P (W)	volt. (V)	HC	L (mm)	W (mm)	H (mm)	Ref. No.
1	418828	2000	240	1	225	230	6.5	24.10052.410

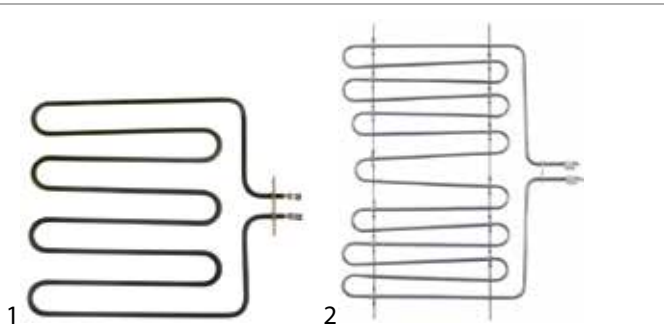

fig.	Vare nr.	P (W)	volt. (V)	HC	L (mm)	W (mm)	H (mm)	Ref. No.
1	416870	1750	230	1	282	257	6.3	00.02025.084
2	419184	2000	230	1	205	262	4	20.80763.000



fig.	Vare nr.	P (W)	volt. (V)	HC	L (mm)	W (mm)	H (mm)	Ref. No.
1	418862	2000	230	1	235	215	35	20.30431.000

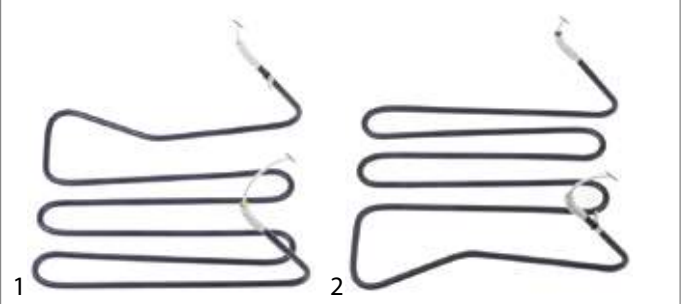

fig.	Vare nr.	P (W)	volt. (V)	HC	L (mm)	W (mm)	H (mm)	Ref. No.
1	415540	2000	230	1	250	210	120	20.26364.000
2	415541	2000	230	1	250	210	120	20.26365.000



fig.	Vare nr.	P (W)	volt. (V)	HC	L (mm)	W (mm)	H (mm)	Ref. No.
1	416001	1500	230	1	265	165	50	10.57401.344

EKU

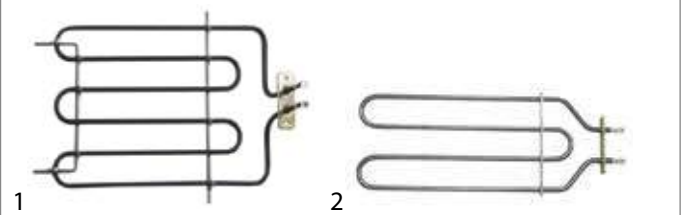

fig.	Vare nr.	P (W)	volt. (V)	HC	L (mm)	W (mm)	H (mm)	Ref. No.
1	415347	1600	230	1	295	205	45	HS 60 E, 15-B-001
2	415141	2900	230	1	425	165	8.5	SME-63
2	415142	3500	230	1	525	167	9	370.423.0 SME70

Electrolux

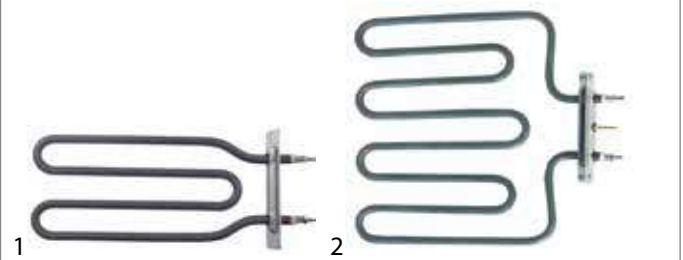

fig.	Vare nr.	P (W)	volt. (V)	HC	L (mm)	W (mm)	H (mm)	Ref. No.
1	420271	1000	230	1	215	95	8.5	003014
2	416653	2000	230	1	225	283	8.5	003016
2	416654	2000	230	1	230	230	8.5	003012



fig.	Vare nr.	P (W)	volt. (V)	HC	L (mm)	W (mm)	H (mm)	Ref. No.
1	420446	2000	230		718	32	32	0M0709



fig.	Vare nr.	P (W)	volt. (V)	HC	L (mm)	W (mm)	H (mm)	Ref. No.
1	415279	1500	230	1	223	430	6.3	0K3586
2	415622	2000	230	1	229	255	8.5	0KD843

fig.	Vare nr.	P (W)	volt. (V)	HC	L (mm)	W (mm)	H (mm)	Ref. No.
3	416581	3000	230	1	357	226	6.3	052836

fig.	Vare nr.	P (W)	volt. (V)	HC	L (mm)	W (mm)	H (mm)	Ref. No.
1	415281	1000	230	1	290	130	6.3	0K3494
2	415559	2100	400	1	260	217	20	0K4777

fig.	Vare nr.	P (W)	volt. (V)	HC	L (mm)	W (mm)	H (mm)	Ref. No.
1	416579	1900	220	1	245	240	6.3	056783
2	416580	2000	220	1	240	333	6.3	056782

Eloma

fig.	Vare nr.	P (W)	volt. (V)	HC	L (mm)	W (mm)	H (mm)	Ref. No.
1	415540	2000	230	1	250	210	120	318049
2	415541	2000	230	1	250	210	120	318048

fig.	Vare nr.	P (W)	volt. (V)	HC	L (mm)	W (mm)	H (mm)	Ref. No.
3	415539	2100	220	1	470	207	6.3	EL0127132
3	415538	2200	230	1	365	178	6.3	EL0102644

Forved

fig.	Vare nr.	P (W)	volt. (V)	HC	L (mm)	W (mm)	H (mm)	Ref. No.
1	416874	450	115	1	344	8.5	8.5	TOSTRESCOR

Franke

fig.	Vare nr.	P (W)	volt. (V)	HC	L (mm)	W (mm)	H (mm)	Ref. No.
1	419184	2000	230	1	205	262	4	409100

fig.	Vare nr.	P (W)	volt. (V)	HC	L (mm)	W (mm)	H (mm)	Ref. No.
1	415540	2000	230	1	250	210	120	279802
2	415541	2000	230	1	250	210	120	279801



GIGA

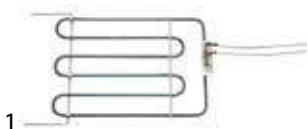

fig.	Vare nr.	P (W)	volt. (V)	HC	L (mm)	W (mm)	H (mm)	Ref. No.
1	416050	1600	220	1	304	208	50	X47800

Giorik

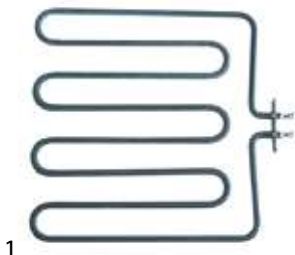

fig.	Vare nr.	P (W)	volt. (V)	HC	L (mm)	W (mm)	H (mm)	Ref. No.
1	415659	2000	230	1	230	303	8.5	6001067
1	415215	2570	230	1	305	297	8.5	6002021
1	415660	2800	230	1	230	298	8.5	6001068
1	415623	3100	230	1	305	295	8.5	6003022
1	415217	3100	400	1	309	295	8.5	6003022

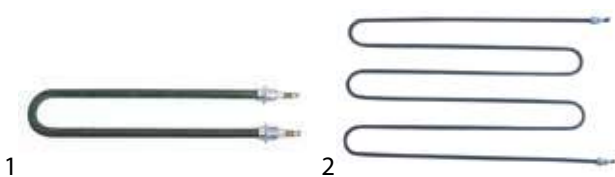

fig.	Vare nr.	P (W)	volt. (V)	HC	L (mm)	W (mm)	H (mm)	Ref. No.
1	415450	650	230	1	265	55	10	6002058
1	416820	930	230	1	260	55	10	6001071
2	415220	2730	230	1	490	270	8.5	6002066



fig.	Vare nr.	P (W)	volt. (V)	HC	L (mm)	W (mm)	H (mm)	Ref. No.
1	416001	1500	230	1	265	165	50	6001066

Haka

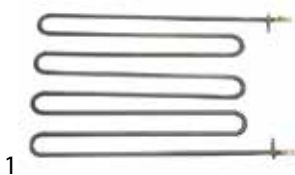

fig.	Vare nr.	P (W)	volt. (V)	HC	L (mm)	W (mm)	H (mm)	Ref. No.
1	415645	2250	230	1	330	215	6.5	9019

Hatco



fig.	Vare nr.	P (W)	volt. (V)	HC	L (mm)	W (mm)	H (mm)	Ref. No.
1	418722	600	220	1	210	90	40	X02.09.259.00
1	418721	700	220	1	210	85	40	X02.09.258.00
1	418724	900	220	1	290	110	40	X02.09.261.00
1	418723	1000	220	1	290	90	40	X02.09.260.00



fig.	Vare nr.	P (W)	volt. (V)	HC	L (mm)	W (mm)	H (mm)	Ref. No.
1	417538	275	220	1	34	-	-	R02.09.205.00

Inoksan

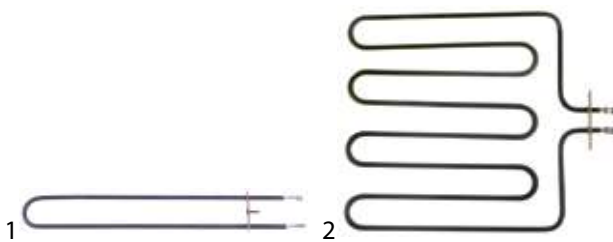

fig.	Vare nr.	P (W)	volt. (V)	HC	L (mm)	W (mm)	H (mm)	Ref. No.
1	416860	500	230	1	295	47	6.5	24407022
2	416870	1750	230	1	282	257	6.3	24507022

Juno

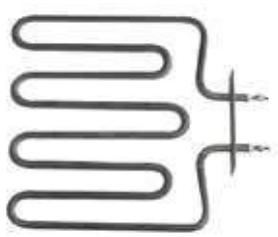

fig.	Vare nr.	P (W)	volt. (V)	HC	L (mm)	W (mm)	H (mm)	Ref. No.
1	415559	2100	400	1	260	217	20	0K4777

Krefftt



fig.	Vare nr.	P (W)	volt. (V)	HC	L (mm)	W (mm)	H (mm)	Ref. No.
1	416653	2000	230	1	225	283	8.5	75-3804

1

fig.	Vare nr.	P (W)	volt. (V)	HC	L (mm)	W (mm)	H (mm)	Ref. No.
1	415621	2000	230	1	257	230	8.5	75-3706

Kromo



1

fig.	Vare nr.	P (W)	volt. (V)	HC	L (mm)	W (mm)	H (mm)	Ref. No.
1	416647	2000	230	1	225	208	8.5	DW9153
1	416646	2000	230	1	290	216	8.5	DW9113

Lasa



1

fig.	Vare nr.	P (W)	volt. (V)	HC	L (mm)	W (mm)	H (mm)	Ref. No.
1	415938	1800	230	1	330	82	25	3208030

Lotus



1

fig.	Vare nr.	P (W)	volt. (V)	HC	L (mm)	W (mm)	H (mm)	Ref. No.
1	416647	2000	230	1	225	208	8.5	537020500
1	416646	2000	230	1	290	216	8.5	537020600

Mareno



1

fig.	Vare nr.	P (W)	volt. (V)	HC	L (mm)	W (mm)	H (mm)	Ref. No.
1	415140	2000	230	1	435	170	6.3	MA1037316100
1	415141	2900	230	1	425	165	8.5	MA1037316200
1	415142	3500	230	1	525	167	9	MA1037316300



1

fig.	Vare nr.	P (W)	volt. (V)	HC	L (mm)	W (mm)	H (mm)	Ref. No.
1	415938	1800	230	1	330	82	25	1037303813

MBM-Italia



1

fig.	Vare nr.	P (W)	volt. (V)	HC	L (mm)	W (mm)	H (mm)	Ref. No.
1	416654	2000	230	1	230	230	8.5	RIC0002488

MKN

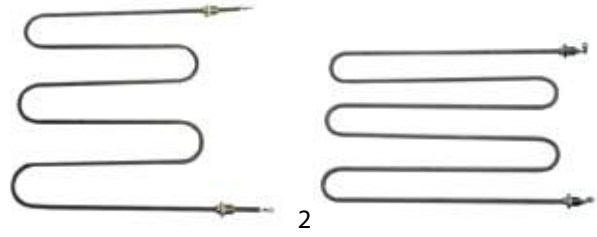

1 2

fig.	Vare nr.	P (W)	volt. (V)	HC	L (mm)	W (mm)	H (mm)	Ref. No.
1	415418	1650	230	1	260	250	6.5	574095
2	415514	1650	230	1	315	200	6.3	574116

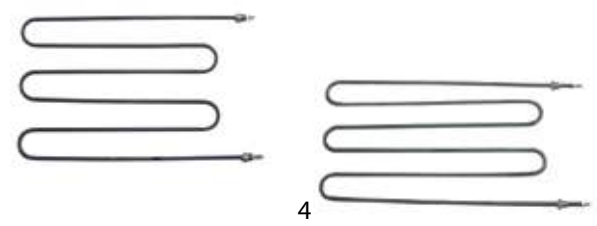

3 4

fig.	Vare nr.	P (W)	volt. (V)	HC	L (mm)	W (mm)	H (mm)	Ref. No.
3	415417	2500	230	1	425	260	6.5	574094
4	415817	3300	230	1	490	260	8.5	574032



Modular



fig.	Vare nr.	P (W)	volt. (V)	HC	L (mm)	W (mm)	H (mm)	Ref. No.
1	418828	2000	240	1	225	230	6.5	66502713

Morice



fig.	Vare nr.	P (W)	volt. (V)	HC	L (mm)	W (mm)	H (mm)	Ref. No.
1	419126	2000	400	1	340	205	45	RS0920

Palux



fig.	Vare nr.	P (W)	volt. (V)	HC	L (mm)	W (mm)	H (mm)	Ref. No.
1	416653	2000	230	1	225	283	8.5	371718
1	416654	2000	230	1	230	230	8.5	371726

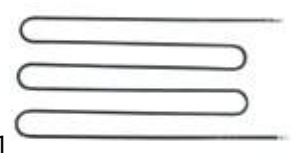

fig.	Vare nr.	P (W)	volt. (V)	HC	L (mm)	W (mm)	H (mm)	Ref. No.
1	415539	2100	220	1	470	207	6.3	127132
1	415538	2200	230	1	365	178	6.3	102644

RM-Gastro

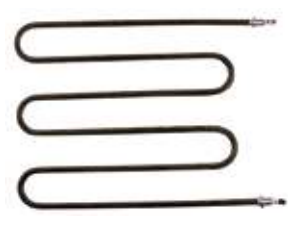

fig.	Vare nr.	P (W)	volt. (V)	HC	L (mm)	W (mm)	H (mm)	Ref. No.
1	418653	2200	230	1	350	260	8.5	401024000

Roller Grill



fig.	Vare nr.	P (W)	volt. (V)	HC	L (mm)	W (mm)	H (mm)	Ref. No.
1	418215	700	245	1	410	10	10	D02108

Salvis

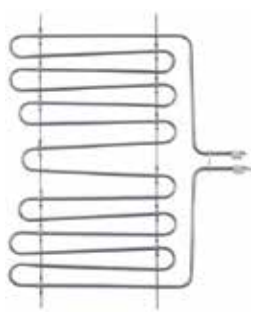

fig.	Vare nr.	P (W)	volt. (V)	HC	L (mm)	W (mm)	H (mm)	Ref. No.
1	419184	2000	230	1	205	262	4	1E409100

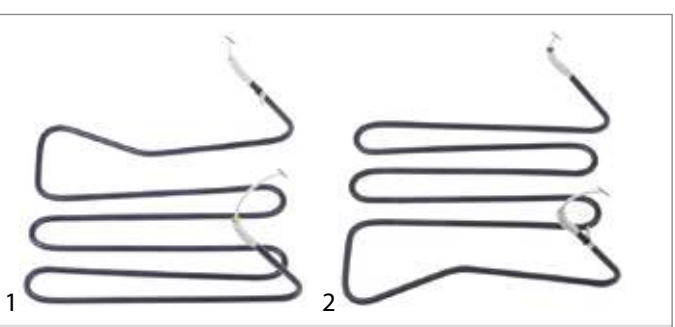

fig.	Vare nr.	P (W)	volt. (V)	HC	L (mm)	W (mm)	H (mm)	Ref. No.
1	415540	2000	230	1	250	210	120	10279802
2	415541	2000	230	1	250	210	120	10279801

Sirman

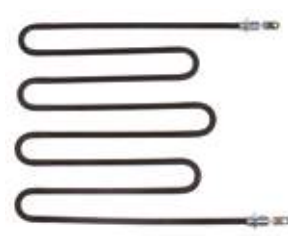



fig.	Vare nr.	P (W)	volt. (V)	HC	L (mm)	W (mm)	H (mm)	Ref. No.
1	418645	1700	230	1	235	211	6.3	1B52565010
1	416594	1900	230	1	230	205	6.3	RCSG200



Star10



1

fig.	Vare nr.	P (W)	volt. (V)	HC	L (mm)	W (mm)	H (mm)	Ref. No.
1	416155	2000	230	1	197	263	8.5	071019
1	416154	2500	230	1	368	255	8.5	071018



1

fig.	Vare nr.	P (W)	volt. (V)	HC	L (mm)	W (mm)	H (mm)	Ref. No.
1	415281	1000	230	1	290	130	6.3	RC00006000

Tecnoinox

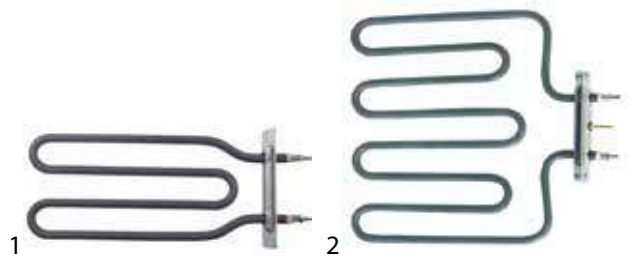

1 2

fig.	Vare nr.	P (W)	volt. (V)	HC	L (mm)	W (mm)	H (mm)	Ref. No.
1	420271	1000	230	1	215	95	8.5	RC00003708
2	416653	2000	230	1	225	283	8.5	RC00003804
2	416654	2000	230	1	230	230	8.5	RC00003706

Therma



1

fig.	Vare nr.	P (W)	volt. (V)	HC	L (mm)	W (mm)	H (mm)	Ref. No.
1	415559	2100	400	1	260	217	20	0K4777

Wiesheu-Wiwa



1

fig.	Vare nr.	P (W)	volt. (V)	HC	L (mm)	W (mm)	H (mm)	Ref. No.
1	415452	750	230	1	400	55	6.3	35682

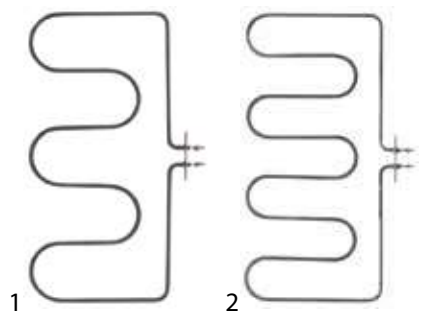

1 2

fig.	Vare nr.	P (W)	volt. (V)	HC	L (mm)	W (mm)	H (mm)	Ref. No.
1	415280	1000	230	1	217	424	6.3	RC00171000
2	415279	1500	230	1	223	430	6.3	RC00000613

Zanussi

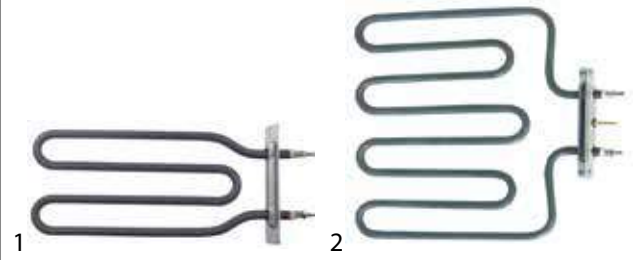

1 2

fig.	Vare nr.	P (W)	volt. (V)	HC	L (mm)	W (mm)	H (mm)	Ref. No.
1	420271	1000	230	1	215	95	8.5	003014
2	416653	2000	230	1	225	283	8.5	003016
2	416654	2000	230	1	230	230	8.5	003012

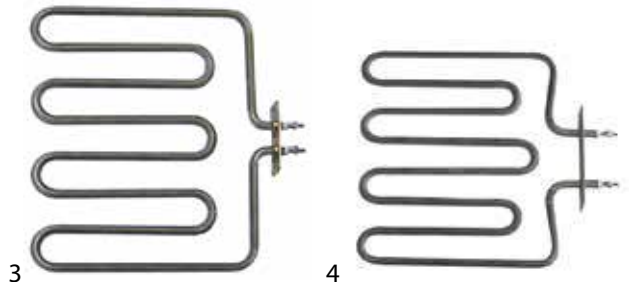

3 4

fig.	Vare nr.	P (W)	volt. (V)	HC	L (mm)	W (mm)	H (mm)	Ref. No.
3	415622	2000	230	1	229	255	8.5	RC00000109
3	415349	2000	400	1	223	252	8.5	RC00000109
4	415621	2000	230	1	257	230	8.5	RC00003706
4	415348	2000	400	1	228	230	8.5	RC00003706

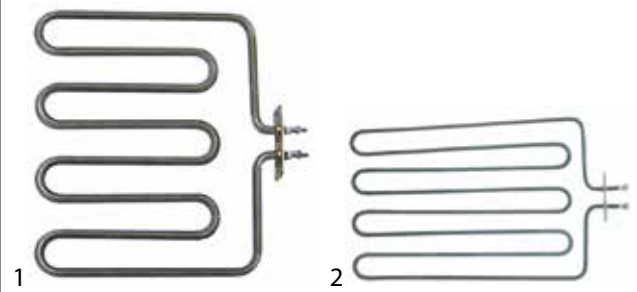

1 2

fig.	Vare nr.	P (W)	volt. (V)	HC	L (mm)	W (mm)	H (mm)	Ref. No.
1	415622	2000	230	1	229	255	8.5	0KD843
2	416581	3000	230	1	357	226	6.3	052836



fig.	Vare nr.	P (W)	volt. (V)	HC	L (mm)	W (mm)	H (mm)	Ref. No.
1	416579	1900	220	1	245	240	6.3	056783
2	416580	2000	220	1	240	333	6.3	056782

fig.	Vare nr.	P (W)	volt. (V)	TS	L (mm)	W (mm)	suitable for	Ref. No.
7	416828	1000	240	1/4"	295	206	Silko	SIR0101532
8	416827	1100	240	M10x1	375	90	Rosinox Silko	RX94805223 SIR0101494
8	416107	1300	240	M10x1	380	100	Gico	241200562

heating elements for transport containers

heating elements for plate warmers

fig.	Vare nr.	P (W)	volt. (V)	TS	L (mm)	W (mm)	suitable for	Ref. No.
1	418304	400	230	M14x1.25	132	126	Mobile-Containing Scholl	957400 71,20,40
2	418277	500	230	-	480	75	Hupfer	014510023

fig.	Vare nr.	P (W)	volt. (V)	L (mm)	W (mm)	suitable for	Ref. No.
1	415714	400	230	555	30	Blanco EGO	105677 20.28910.000
2	415245	416	240	417	202	Rieber	33010104

fig.	Vare nr.	P (W)	volt. (V)	TS	L (mm)	W (mm)	suitable for	Ref. No.
3	415247	800	120	-	668	580	Rieber	33010110
4	415892	900	230	-	628	669	Blanco EGO	146753 20.29739.000

fig.	Vare nr.	P (W)	volt. (V)	L (mm)	W (mm)	suitable for	Ref. No.
3	420441	470	230	390	205	Rieber	3310170
4	415218	500	230	440	155	Blanco	252477

fig.	Vare nr.	P (W)	volt. (V)	TS	L (mm)	W (mm)	suitable for	Ref. No.
5	418273	900	230	-	654	183	Hupfer	014040068
6	418283	1000	230	-	530	30	Hupfer	014001122

heating elements for heating bridges

fig.	Vare nr.	P (W)	volt. (V)	L (mm)	W (mm)	suitable for	Ref. No.
1	418203	350	220	335	-	Cookmax Hatco	R020813500 R02.08.138E.00
1	418202	500	220	485	-	Angelo-Po Cookmax Hatco	3003800 R02.08.136E.00 R02.08.136E.00
1	418204	660	220	634	-	Cookmax Hatco	R02.08.139E.00 R02.08.139E.00
1	418205	800	220	790	-	Cookmax Hatco	R02.08.140E.00 R02.08.140E.00
1	418206	950	220	940	-	Cookmax Hatco	R02.08.141E.00 R02.08.141E.00
1	418207	1100	220	1095	-	Cookmax Hatco	R02.08.142E.00 R02.08.142E.00

Table continues overleaf

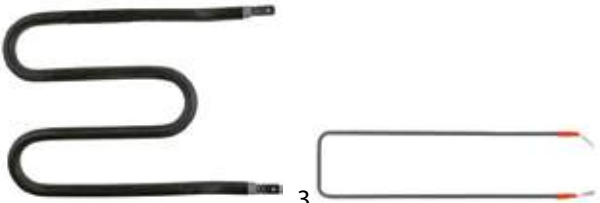



fig.	Vare nr.	P (W)	volt. (V)	L (mm)	W (mm)	suitable for	Ref. No.
1	418208	1250	220	1245	-	Cookmax Hatco	R02.08.143E.00 R02.08.143E.00
1	418209	1400	220	1400	-	Cookmax Hatco	R02.08.144E.00 R02.08.144E.00
1	418210	1560	220	1565	-	Cookmax Hatco	R02.08.145E.00 R02.08.145E.00
1	418211	1725	220	1715	-	Cookmax Hatco	R02.08.148E.00 R02.08.148E.00
2	418657	500	230	165	125	Cookmax RM-Gastro	401021500 401021500
3	418241	500	230	385	105	EGO Scholl	20.26582.000 71,20,02

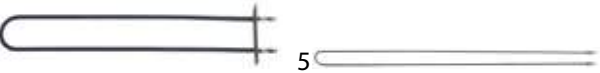

fig.	Vare nr.	P (W)	volt. (V)	L (mm)	W (mm)	suitable for	Ref. No.
4	416665	1000	230	427	60	Mareno	MA1037041613
5	416445	1400	230	875	70	MKN	574060
5	416446	1800	230	1125	70	MKN	574061
5	418426	3280	230	970	42	CB	07030900

heating elements for heated cabinets

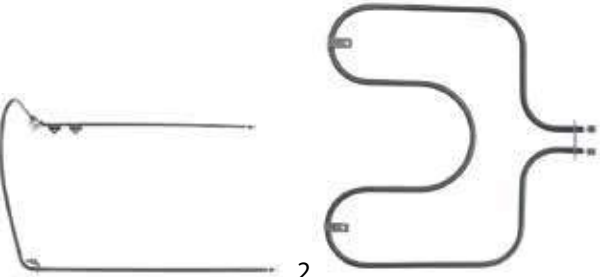

fig.	Vare nr.	P (W)	volt. (V)	L (mm)	W (mm)	suitable for	Ref. No.
1	418741	400	230	220	350	Bartscher Cookmax	040827 040827
2	416719	600	230	259	275	Roller Grill VEGA	D02014 93272

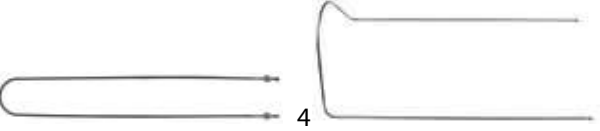

fig.	Vare nr.	P (W)	volt. (V)	L (mm)	W (mm)	suitable for	Ref. No.
3	418946	700	230	745	110	Capic	E150532
4	418742	750	230	220	360	Bartscher Cookmax	040577 040577

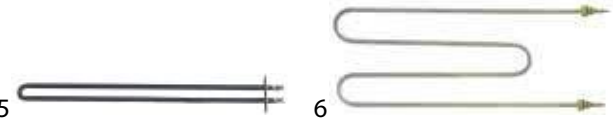

fig.	Vare nr.	P (W)	volt. (V)	L (mm)	W (mm)	suitable for	Ref. No.
5	416575	770	240	462	33	Mareno	MA1215400
6	416509	1000	230	455	180	Schöler Suprema	1-B0010 —

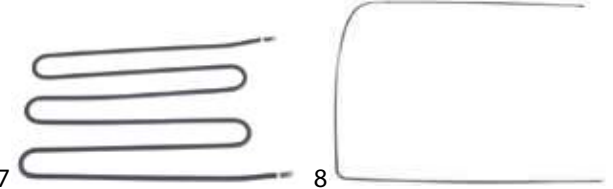

fig.	Vare nr.	P (W)	volt. (V)	L (mm)	W (mm)	suitable for	Ref. No.
7	418344	1200	220	395	220	Dexion Emainox MBM-Italia	3710003 3710003 3710003
8	418743	1200	230	220	680	Bartscher Cookmax	040576 040576



fig.	Vare nr.	P (W)	volt. (V)	L (mm)	W (mm)	suitable for	Ref. No.
9	419155	1200	230	350	150	Tecnoeka	01201441
10	415435	1500	220	425	100	Palux	083577



fig.	Vare nr.	P (W)	volt. (V)	L (mm)	W (mm)	suitable for	Ref. No.
11	418845	1500	230	480	70	Capic	E150840
12	415323	1600	230	383	96	EGO Malag	24.33117.000 105619

heating elements for heated trolleys

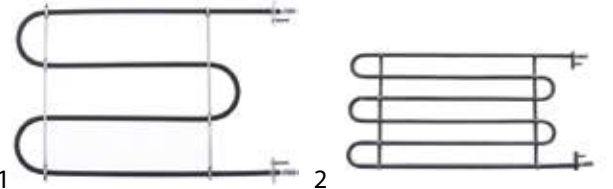

fig.	Vare nr.	P (W)	volt. (V)	L (mm)	W (mm)	Ref. No.
1	415894	150	230	300	198	105454 20.23032.000
2	415895	250	230	490	200	105029 20.21843.000
2	415544	700	230	392	198	105020 20.23487.040
2	415587	1000	230	390	197	105030 20.23487.010

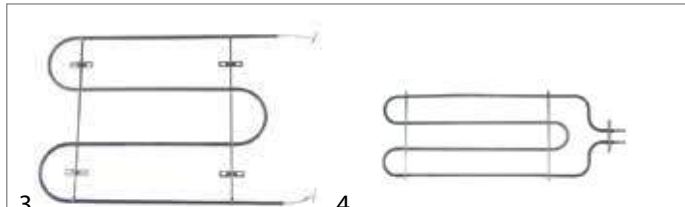



fig.	Vare nr.	P (W)	volt. (V)	L (mm)	W (mm)	Ref. No.
3	418278	350	230	422	306	105793 20.29666.000
4	415340	400	230	477	172	360060.3000370
4	415339	600	230	480	175	20.21389.010 360080.3000352
4	415338	900	230	480	174	360100

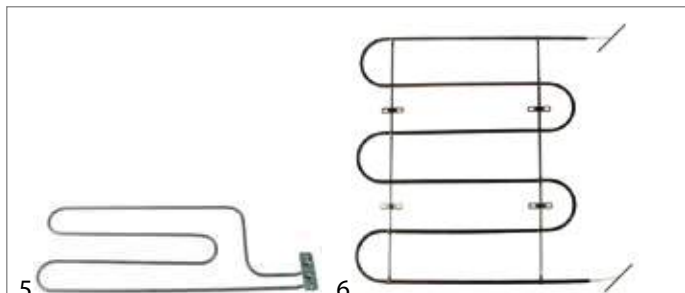

fig.	Vare nr.	P (W)	volt. (V)	L (mm)	W (mm)	Ref. No.
5	418259	450	230	475	181	014001112
6	418284	550	230	422	468	105794 20.29667.000

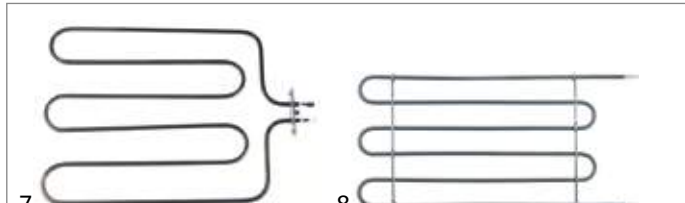

fig.	Vare nr.	P (W)	volt. (V)	L (mm)	W (mm)	Ref. No.
7	418257	700	230	345	254	014001104-UL
8	420303	700	230	400	200	00105020 20.30194.000 OKA636

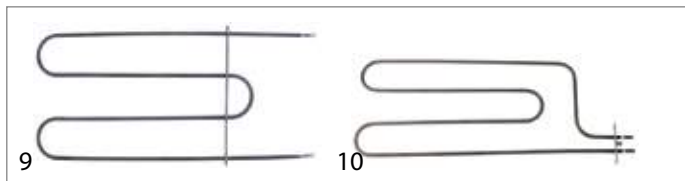

fig.	Vare nr.	P (W)	volt. (V)	L (mm)	W (mm)	Ref. No.
9	418851	700	230	430	200	105881 20.29861.000
10	418258	700	230	446	178	014001111

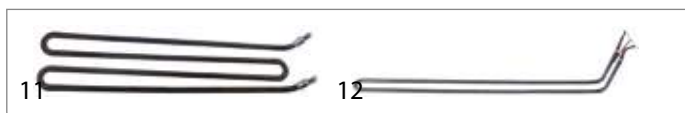

fig.	Vare nr.	P (W)	volt. (V)	L (mm)	W (mm)	Ref. No.
11	418802	1000	230	385	80	12034205
11	418801	1500	230	390	80	12032595
12	418283	1000	230	530	30	014001122

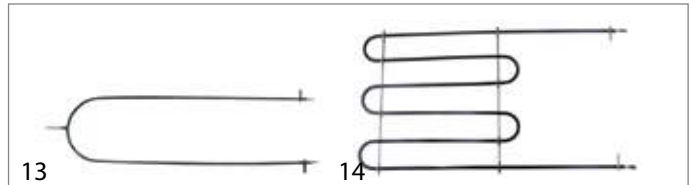

fig.	Vare nr.	P (W)	volt. (V)	L (mm)	W (mm)	Ref. No.
13	420298	1200	230	650	180	374270 20.41618.000
14	418309	1600	230	465	257	3000349

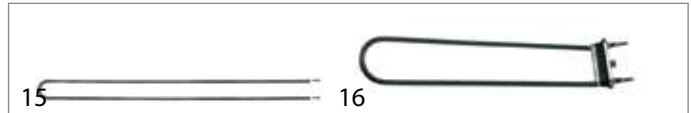

fig.	Vare nr.	P (W)	volt. (V)	L (mm)	W (mm)	Ref. No.
15	418308	1600	230	685	53	957460
16	415549	1750	240	340	66	33010116



fig.	Vare nr.	P (W)	volt. (V)	L (mm)	W (mm)	Ref. No.
17	420304	2200	230	395	200	00105983 20.30451.000

heating elements for saladettes

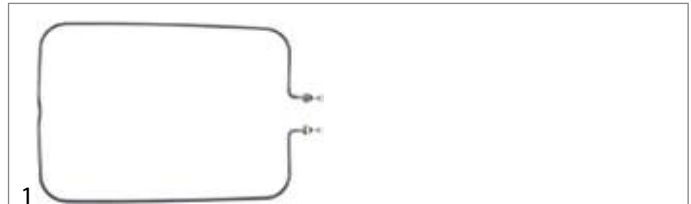

fig.	Vare nr.	P (W)	volt. (V)	L (mm)	W (mm)	H (mm)	tube ø (mm)	suitable for	Ref. No.
1	420453	1800	230	580	383	8.5	8.5	Roller Grill	SD02107

dry heating elements for dishwashers

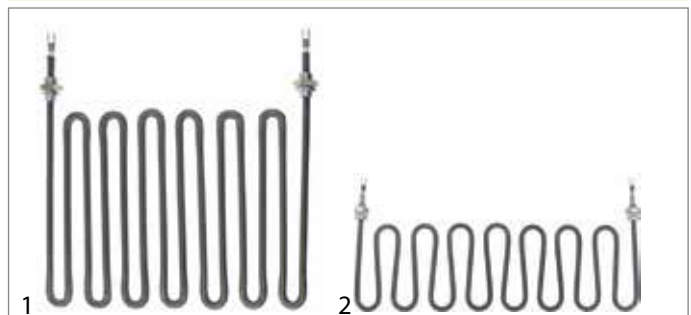

fig.	Vare nr.	P (W)	volt. (V)	L (mm)	W (mm)	tube ø (mm)	suitable for	Ref. No.
1	420321	1100	240	185	220	6.5	Jemi	2001302
2	420152	2000	230	115	345	6.3	Winterhalter	3103137

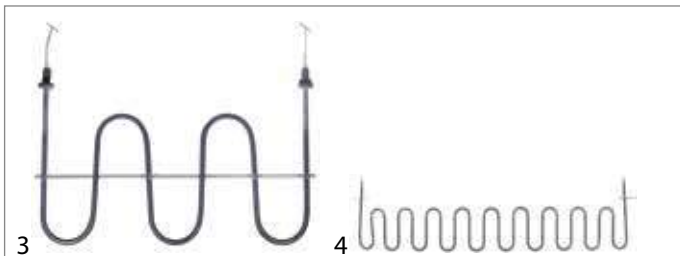

fig.	Vare nr.	P (W)	volt. (V)	L (mm)	W (mm)	tube ø (mm)	suitable for	Ref. No.
3	420052	2000	230	175	295	6.5	EGO Meiko	20.26152.000 0101136
4	420348	2500	230	130	690	6.3	Winterhalter	5101415

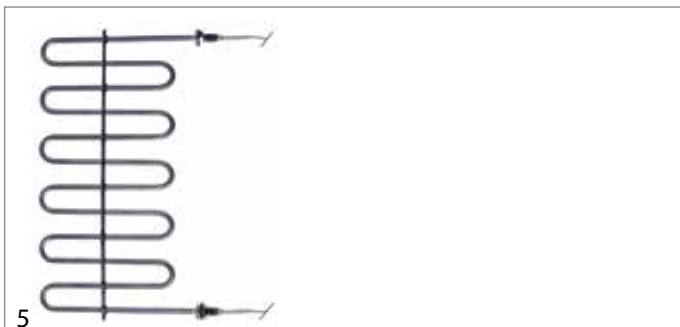

fig.	Vare nr.	P (W)	volt. (V)	L (mm)	W (mm)	tube ø (mm)	suitable for	Ref. No.
5	418852	3000	230	170	295	6.5	EGO Meiko	20.29651.000 0101135

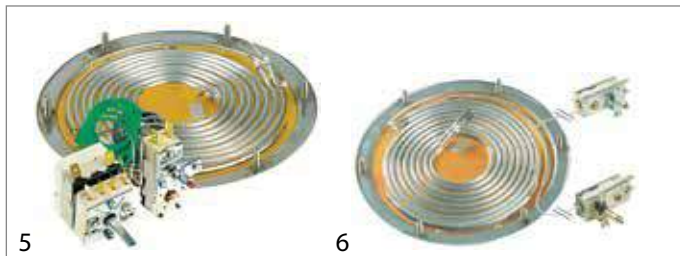

fig.	Vare nr.	P (W)	volt. (V)	HC (mm)	ø (mm)	ST (°C)	thermostat (°C)	suitable for	Ref. No.
5	418467	1800	230	2	196	250	105	EGO	28.06019.500
5	419008	3000	400	2	196	250	128	EGO	28.06021.100
6	418242	1800	230	2	196	250	117	EGO	28.06014.000

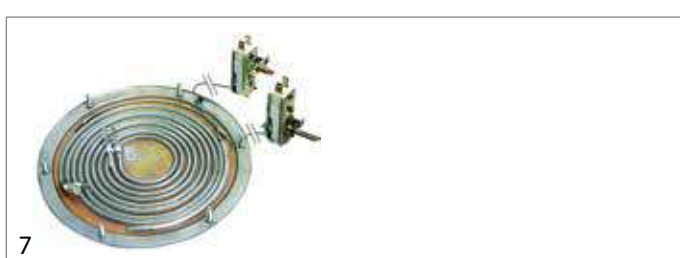

fig.	Vare nr.	P (W)	volt. (V)	HC (mm)	ø (mm)	ST (°C)	thermostat (°C)	suitable for	Ref. No.
7	415337	1800	230	2	196	250	128	EGO	28.06013.300
7	415661	3000	230	2	196	250	128	EGO	28.06013.400

bottom heaters

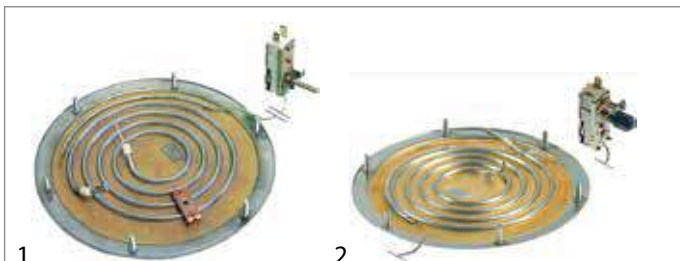

fig.	Vare nr.	P (W)	volt. (V)	HC (mm)	ø (mm)	ST (°C)	thermostat (°C)	suitable for	Ref. No.
1	415336	500	230	1	196	-	128	EGO	28.06013.100
1	415760	1800	230	1	196	-	128	EGO	28.06013.200
2	418429	1800	230	1	196	250		EGO	28.06020.000

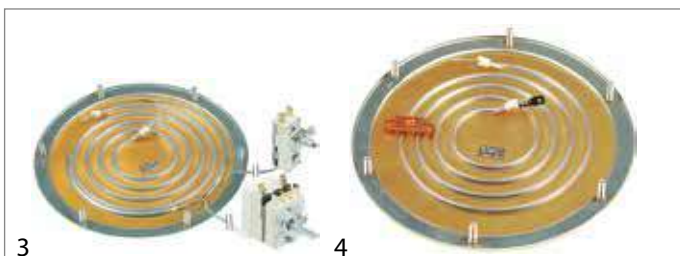

fig.	Vare nr.	P (W)	volt. (V)	HC (mm)	ø (mm)	ST (°C)	thermostat (°C)	suitable for	Ref. No.
3	418430	1800	230	1	196	250	128	EGO	28.06020.100
4	418473	1800	230	1	196	-		EGO	28.06018.300

heaters

Küppersbusch

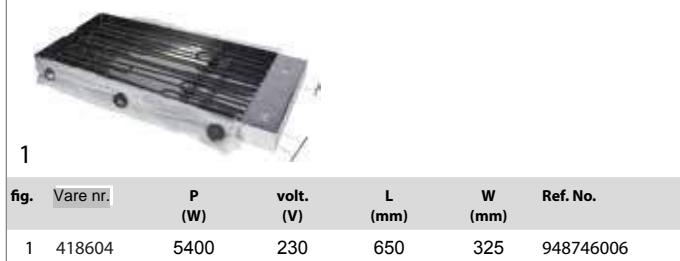

fig.	Vare nr.	P (W)	volt. (V)	L (mm)	W (mm)	Ref. No.
1	418604	5400	230	650	325	948746006

Rieber



fig.	Vare nr.	P (W)	volt. (V)	L (mm)	W (mm)	Ref. No.
1	420154	300	220-240	407	228	55050213
2	418282	550	240	130	133	59050608



3



4

fig.	Vare nr.	P (W)	volt. (V)	L (mm)	W (mm)	Ref. No.
3	601521	810	230	270	240	55050244
4	601786	1600	230	245	220	59050609



5



6

fig.	Vare nr.	P (W)	volt. (V)	L (mm)	W (mm)	Ref. No.
5	601255	1600	115/230	240	240	58233423
5	601251	2400	115/230	240	240	58233422
6	601256	1700	115/230	240	240	58233418
6	601257	2400	115/230	240	240	58233417



7

fig.	Vare nr.	P (W)	volt. (V)	L (mm)	W (mm)	Ref. No.
7	601250	2400	230	235	235	53300102

heating cables

connection on both sides

with wire end ferrules



pos.	Vare nr.	P (W)	volt. (V)	L (mm)	L1 (unheated) (mm)	L2 (chauffé) (mm)
1	419147	7	230	3250	1150	1050
2	420027	19	12	2500	1000	1500
3	416310	20	230	6190	800	4590
4	420379	25.2	230	3900	1800	2100
5	420378	36	230	4500	1500	3000
6	419220	37	220	9000	740	8260
7	420026	43.2	230	6200	800	5400
8	420380	44	230	6500	2650	3650

pos.	Vare nr.	P (W)	volt. (V)	L (mm)	L1 (unheated) (mm)	L2 (chauffé) (mm)
9	416311	46	230	7560	800	5960
10	420372	54	230	5000	1000+1000	3000
11	420373	72	230	6000	1000+1000	4000
12	420374	90	230	7000	1000+1000	5000
13	420375	108	230	8000	1000+1000	6000
14	420376	126	230	9000	1000+1000	7000
15	420377	144	230	10000	1000+1000	8000

with male fastons



pos.	Vare nr.	P (W)	volt. (V)	L (mm)	pos.	Vare nr.	P (W)	volt. (V)	L (mm)
1	418807	18	230	4750	6	417576	45.3	230	5000
2	418808	20	220	3450	7	418806	57	230	6400
3	418804	31	230	3200	8	418803	60	230	7400
4	418809	41	220	6250	9	418339	600	230	9900
5	418805	43	230	5000					

with male faston and wire end ferrule



fig.	Vare nr.	P (W)	volt. (V)	L (mm)	L1 (unheated) (mm)	L2 (chauffé) (mm)
1	420062	42.3	230	6300	2100	4200

connection on both sides (metal braided)



pos.	Vare nr.	P (W)	volt. (V)	L (mm)	L1 (unheated) (mm)	L2 (chauffé) (mm)
1	416330	26	230	2100	2x540	1020
2	417602	52	230	6700	200	6500
3	416331	53	230	3100	2x540	2020
4	416332	95	230	4600	2x550	3500
5	417614	107	230		1500+1500	5000
6	416333	130	230	6000	2x520	4960
7	416334	188	230	8080	2x540	7000
8	416335	272	230	11000	2x540	9920

connection single-sided



pos.	Vare nr.	P (W)	volt. (V)	L (mm)	L1 (unheated) (mm)	L2 (chauffé) (mm)
1	378455	6	240	1700	1050	650
2	418570	12	230	3190	1650	1540
3	416336	16	230	2900	2400	500
4	416337	25	230	2900	1900	1000
5	417615	25	230	3000	1300	1700
6	418614	35	220	1910	870	1040
7	418734	37	230	1670	130	1650
8	418735	37	230	1740	190	1650

Table continues overleaf



pos.	Vare nr.	P (W)	volt. (V)	L (mm)	L1 (unheated) (mm)	L2 (chauffé) (mm)
9	381244	40	220	2000	1000	1000
10	417518	50	230	2000	1000	1000
11	418736	50	230	2120	130	2010
12	416338	55	230	2500	500	2000
13	418737	62	230	2680	130	2550
14	381250	80	220	3000	950	2050
15	417519	100	230	3000	1000	2000
16	417520	150	230	4000	1000	3000
17	417521	200	230	5000	1000	4000
18	417522	250	230	6000	1000	5000
19	417523	300	230	7000	1000	6000

supplied by meter



pos.	Vare nr.	volt. (V)	Ohm/meter (Ohm/m)	power/meter (W/m)
1	416365	230	105	29
2	418405	230	205	-
3	416340	230	365	29
4	550456	230	-	20

with parallel heating wire guide

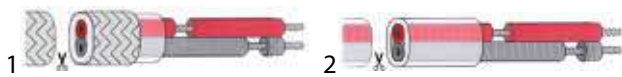

fig.	Vare nr.	volt. (V)	Ohm/meter (Ohm/m)	power/meter (W/m)	ø (mm)
1	416342	230	1750	30	8
2	416341	230	1756	30	7



fig.	Vare nr.	volt. (V)	Ohm/meter (Ohm/m)	power/meter (W/m)	ø (mm)
3	416345	230	5290	10	8/10

heating cartridges

Angelo-Po



fig.	Vare nr.	P (W)	volt. (V)	ø (mm)	L (mm)	Ref. No.
1	418892	300	230	12	240	32G3310

Aristarco



fig.	Vare nr.	P (W)	volt. (V)	ø (mm)	L (mm)	Ref. No.
1	420320	150	230	12.6	104	00003370

Emainox



fig.	Vare nr.	P (W)	volt. (V)	ø (mm)	L (mm)	Ref. No.
1	418346	400	230	10	360	3710022

Frenox



fig.	Vare nr.	P (W)	volt. (V)	ø (mm)	L (mm)	Ref. No.
1	419212	350	220	12	255	B00REZ106

Gaggia



pos.	Vare nr.	P (W)	volt. (V)	ø (mm)	L (mm)	Ref. No.
1	400338	80	240	12.7	55	DM1804/001

Ilsa



fig.	Vare nr.	P (W)	volt. (V)	ø (mm)	L (mm)	Ref. No.
1	416670	1800	230	30	315	R241050

Isa



fig.	Vare nr.	P (W)	volt. (V)	ø (mm)	L (mm)	Ref. No.
1	419216	250	230	11	110	41850002800
1	419218	400	230	11	240	418500030100
2	419217	700	230	11	355	418500020000

Lotus



fig.	Vare nr.	P (W)	volt. (V)	ø (mm)	L (mm)	Ref. No.
1	416522	2000	230	30	300	537021200

Mondial



fig.	Vare nr.	P (W)	volt. (V)	ø (mm)	L (mm)	Ref. No.
1	417577	190	230	12	180	1192081
1	417571	230	230	12	180	1192081

NuovaSimonelli



fig.	Vare nr.	P (W)	volt. (V)	ø (mm)	L (mm)	Ref. No.
1	417194	600	230	10	74	14100037



Offcar



fig.	Vare nr.	P (W)	volt. (V)	ø (mm)	L (mm)	Ref. No.
1	416670	1800	230	30	315	443655

Sagi



fig.	Vare nr.	P (W)	volt. (V)	ø (mm)	L (mm)	Ref. No.
1	418892	300	230	12	240	32G3310

Winterhalter



fig.	Vare nr.	P (W)	volt. (V)	ø (mm)	L (mm)	Ref. No.
1	420161	1800	200-254	20	215	30000122
1	420347	2500	200-255	20	215	30002495

Zoin



fig.	Vare nr.	P (W)	volt. (V)	ø (mm)	L (mm)	Ref. No.
1	417612	400	230	12.2	283	R010-PTC/3

heating plates

Cookmax



fig.	Vare nr.	P (W)	volt. (V)	Ref. No.
1	417456	70	230	11624

Melitta



fig.	Vare nr.	P (W)	volt. (V)	Ref. No.
1	417456	70	230	11624

Nayati

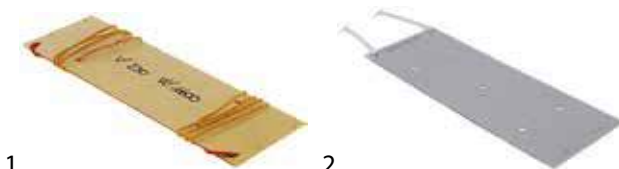

fig.	Vare nr.	P (W)	volt. (V)	Ref. No.
1	418427	1600	230	PS.EH003
2	419128	2500	400	PS.EH001-D



fig.	Vare nr.	P (W)	volt. (V)	Ref. No.
3	418433	2700	230	PS.EH002

Saro



fig.	Vare nr.	P (W)	volt. (V)	Ref. No.
1	417569	58	230	S160P022

Stahl



fig.	Vare nr.	P (W)	volt. (V)	Ref. No.
1	415734	1000	230	160055



heater battery

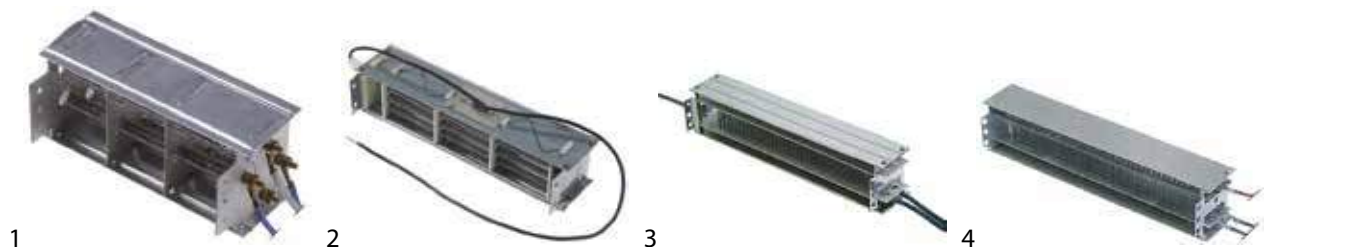

fig.	Vare nr.	MD (mm)	W (mm)	H (mm)	P (W)	volt. (V)	TR (°C)	HC	suitable for	Ref. No.
1	419034	95	116	45	800	230	90	1	Inoxtrend	FX0058-00
2	415115	185	38	40	2000	230	125	2	Emmepi	827915
3	415121	185	40	35	2000	230		2	Mobile-Containing	957230
3	415114	185	40	35	2000	230	105	2	Rieber	33010701
4	415122	185	40	35	2000	230	105	2	Angelo-Po CB Electrolux Emmepi Grandimpianti Küppersbusch	32G1990 07032361 0k4812 827915 52AD0000005 402628
4	420267	185	40	35	2000	230	105	2	—	—



fig.	Vare nr.	MD (mm)	W (mm)	H (mm)	P (W)	volt. (V)	TR (°C)	HC	suitable for	Ref. No.
5	420240	-	90	45	6000	240/415	125	6	Electrolux	0W6266

heating rods

Charvet



fig.	Vare nr.	P (W)	volt. (V)	L (mm)	W (mm)	H (mm)	Ref. No.
1	418459	1000	240	630	38	8	02030A

EGO



fig.	Vare nr.	P (W)	volt. (V)	L (mm)	W (mm)	H (mm)	Ref. No.
1	480001	225	230	340	17	9.5	31.03401.012
1	480011	250	230	400	17	9.5	31.04005.012
1	480005	300	230	432	17	9.5	31.04321.015
1	480013	300	230	432	17	9.5	31.04325.012
1	480015	300	230	458	17	9.5	31.04585.112
1	480050	400	230	600	22.5	11	32.06005.012
1	480051	400	400	600	22.5	11	32.06005.013
1	480053	450	400	720	22.5	11	32.07205.001
1	480056	500	230	1030	22.5	10	32.10305.002



fig.	Vare nr.	P (W)	volt. (V)	L (mm)	W (mm)	H (mm)	Ref. No.
1	480058	650	230	1300	22.5	10	32.13005.002
2	480017	300	400	458	17	9.5	31.04582.161
2	480082	325	230	458	17	9.5	31.04582.255
2	480081	325	400	458	17	9.5	31.04582.284
2	480035	500	230	450	22.5	11	32.04502.172 32.04502.192
2	480030	600	230	600	22.5	11	32.06002.002
2	480068	600	400	540	22.5	11	32.05402.134
2	480031	600	400	600	22.5	11	32.06002.001
2	480032	700	230	600	22.5	11	32.06002.114
2	480033	700	400	600	22.5	11	32.06002.113
2	480038	700	400	600	22.5	11	32.06002.606
3	480039	550	400	540	22.5	11	32.05402.001



Electrolux



fig.	Vare nr.	P (W)	volt. (V)	L (mm)	W (mm)	H (mm)	Ref. No.
1	480005	300	230	432	17	9.5	0K9758
2	480082	325	230	458	17	9.5	0K0396
2	480081	325	400	458	17	9.5	0H6086
2	480030	600	230	600	22.5	11	0G2307
2	480031	600	400	600	22.5	11	0H6091
2	480038	700	400	600	22.5	11	0G2306

Juno



fig.	Vare nr.	P (W)	volt. (V)	L (mm)	W (mm)	H (mm)	Ref. No.
1	480082	325	230	458	17	9.5	0K0396
1	480081	325	400	458	17	9.5	0H6086
1	480030	600	230	600	22.5	11	0G2307
1	480031	600	400	600	22.5	11	0H6091
1	480038	700	400	600	22.5	11	0G2306

King



fig.	Vare nr.	P (W)	volt. (V)	L (mm)	W (mm)	H (mm)	Ref. No.
1	480005	300	230	432	17	9.5	0K9758

Küppersbusch



fig.	Vare nr.	P (W)	volt. (V)	L (mm)	W (mm)	H (mm)	Ref. No.
1	480035	500	230	450	22.5	11	181553
1	480032	700	230	600	22.5	11	181524
1	480033	700	400	600	22.5	11	181525

Malag



fig.	Vare nr.	P (W)	volt. (V)	L (mm)	W (mm)	H (mm)	Ref. No.
1	480035	500	230	450	22.5	11	144266
1	480032	700	230	600	22.5	11	118028

Morice



fig.	Vare nr.	P (W)	volt. (V)	L (mm)	W (mm)	H (mm)	Ref. No.
1	418459	1000	240	630	38	8	RS0859

Therma



fig.	Vare nr.	P (W)	volt. (V)	L (mm)	W (mm)	H (mm)	Ref. No.
1	480031	600	400	600	22.5	11	0H6091
1	480038	700	400	600	22.5	11	0G2306

induction coils



fig.	Vare nr.	description
1	403043	induction coils
2	404010	induction coils ø 220mm H 10mm



fig.	Vare nr.	description
3	404009	induction coils ø 260mm H 50mm for induction wok

ceramic heaters

ø8.5/9.5 x 330mm



technical data:
voltage 230V
cable beaded cord
length 330mm

pos.	Vare nr.	P (W)	ø (mm)	pos.	Vare nr.	P (W)	ø (mm)
1	415307	250	9.5	2	415125	400	8.5



ø16/17 x 245mm



technical data:
voltage 230V
cable beaded cord
length 245mm

pos.	Vare nr.	P (W)	ø (mm)	pos.	Vare nr.	P (W)	ø (mm)
1	415304	250	16/17	2	415305	400	16/17

125x60mm



technical data:
voltage 230V
cable beaded cord
length 122mm
width 60mm
height 34mm

pos.	Vare nr.	P (W)	pos.	Vare nr.	P (W)	pos.	Vare nr.	P (W)
1	415105	125	3	415107	325	5	415108	500
2	415106	200	4	418404	400			

245x60mm



technical data:
voltage 230V
cable beaded cord
length 245mm
width 60mm
height 35mm

pos.	Vare nr.	P (W)	pos.	Vare nr.	P (W)	pos.	Vare nr.	P (W)
1	415101	250	3	418402	500	5	418403	800
2	415102	400	4	415103	650	6	415104	1000

accessories



1 2

fig.	Vare nr.	description
1	415111	reflector L 125mm W 95mm H 30mm thickness 0,8mm
2	415110	reflector L 245mm W 95mm H 31mm thickness 0,75mm



3 4 5

fig.	Vare nr.	description
3	415109	spring clip
4	560023	distance washers L 13mm aluminium ID ø M5mm
5	560020	carriage bolts M5 L 30mm head ø 13mm

contact heaters



1 2

fig.	Vare nr.	P (W)	volt. (V)	L (mm)	W (mm)	H (mm)	suitable for	Ref. No.
1	416237	1400	230	133	120	10	Capic Colged Elettrobar	L201017 230104 999206
2	419178	1500	230	-	-	-	Project	RPA01



3

fig.	Vare nr.	P (W)	volt. (V)	L (mm)	W (mm)	H (mm)	suitable for	Ref. No.
3	416056	1800	230	257	112	27	Winterhalter	61005231

pilot heating elements



1 2

fig.	Vare nr.	P (W)	volt. (V)	HC	L (mm)	W (mm)	suitable for	Ref. No.
1	416200	300	230	1	207	22	Ambach EGO	5024709751 20.81132.210
2	415793	450	230	1	194	42	Lohberger Voss	F7U47107 47107



3 4

fig.	Vare nr.	P (W)	volt. (V)	HC	L (mm)	W (mm)	suitable for	Ref. No.
3	415455	450	230	1	242	18.5	Electrolux Juno	OK0604 OK0604
4	415607	500	230	1	295	20	Ascobloc EGO Krefft Küppersbusch Palux	8181729 20.80461.000 49-181729 181729 702188





5 6

fig.	Vare nr.	P (W)	volt. (V)	HC	L (mm)	W (mm)	suitable for	Ref. No.
5	415653	600	230	1	280	36	Küppersbusch Malag Thielmann	182415 105708 143895
6	415460	1000	230	1	230	65	EGO EGO Electrolux Juno	20.40488.000 20.40631.010 0H6199 0H6199





quartz heating elements



Anitec

									
fig.	Vare nr.	P (W)	volt. (V)	Ref. No.	fig.	Vare nr.	P (W)	volt. (V)	Ref. No.
1	416414	500	115	071014	2	416153	600	230	071051.1
2	416152	500	230	071014.1	2	418834	600	230	071051



Aristarco

									
fig.	Vare nr.	P (W)	volt. (V)	Ref. No.	fig.	Vare nr.	P (W)	volt. (V)	Ref. No.
1	416034	1000	230	00000603					
2	416020	-	-	00000615					

Bartscher

									
fig.	Vare nr.	P (W)	volt. (V)	Ref. No.	fig.	Vare nr.	P (W)	volt. (V)	Ref. No.
1	420048	340	76	A015160016					
2	416858	420	115	A030008462					

Bertos

									
fig.	Vare nr.	P (W)	volt. (V)	Ref. No.	fig.	Vare nr.	P (W)	volt. (V)	Ref. No.
1	415311	1000	230	30014100					
2	416020	-	-	30043100					



Capic

									
fig.	Vare nr.	P (W)	volt. (V)	Ref. No.	fig.	Vare nr.	P (W)	volt. (V)	Ref. No.
1	420168	-	-	E302112	2	420169	-	-	E150526

Ceado

				
fig.	Vare nr.	P (W)	volt. (V)	Ref. No.
1	420274	-	-	50111

CF-Cenedese

									
fig.	Vare nr.	P (W)	volt. (V)	Ref. No.	fig.	Vare nr.	P (W)	volt. (V)	Ref. No.
1	419205	300	115	63.7.1097	2	416187	400	115	63.7.1094
1	419204	500	115	63.7.1095					



Chergui

				
fig.	Vare nr.	P (W)	volt. (V)	Ref. No.
1	418477	-	-	03EFTQ0020



Cookmax

				
fig.	Vare nr.	P (W)	volt. (V)	Ref. No.
1	416187	400	115	401023400
1	418625	500	110	401023500

Dühr

									
fig.	Vare nr.	P (W)	volt. (V)	Ref. No.	fig.	Vare nr.	P (W)	volt. (V)	Ref. No.
1	416174	450	75	DW8075	1	417534	500	115	DW8156

Dimplex

									
fig.	Vare nr.	P (W)	volt. (V)	Ref. No.	fig.	Vare nr.	P (W)	volt. (V)	Ref. No.
1	415306	650	230	105019					
2	415113	1300	230	106169					

Elettrobar



									
fig.	Vare nr.	P (W)	volt. (V)	Ref. No.	fig.	Vare nr.	P (W)	volt. (V)	Ref. No.
1	416494	500	115	230031					
2	415311	1000	230	923003					

				
fig.	Vare nr.	P (W)	volt. (V)	Ref. No.
3	416493	-	-	484001

Faba

				
fig.	Vare nr.	P (W)	volt. (V)	Ref. No.
1	416143	1000	230	P404/1



Fiamma



fig.	Vare nr.	P (W)	volt. (V)	Ref. No.
1	416583	250	75	4.0.075.1137
1	416582	330	75	4.0.075.1135
1	416584	450	115	4.0.074.1003

Fimar





fig.	Vare nr.	P (W)	volt. (V)	Ref. No.	fig.	Vare nr.	P (W)	volt. (V)	Ref. No.
1	416564	400	110	CO1020	2	416563	500	230	CO1085



fig.	Vare nr.	P (W)	volt. (V)	Ref. No.
3	416486	-	-	CO1019

Forved

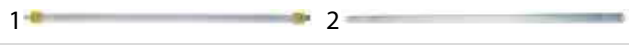



fig.	Vare nr.	P (W)	volt. (V)	Ref. No.
1	416187	400	115	TOSTRES01
1	418625	500	110	TOSTRES02
2	416873	500	75	TOSTRES04
2	416876	800	110	SALAMADRES
2	416872	1000	115	TOSTRES02

FriFri





fig.	Vare nr.	P (W)	volt. (V)	Ref. No.	fig.	Vare nr.	P (W)	volt. (V)	Ref. No.
1	415302	400	230	400595	1	415313	420	230	25550001
1	415309	400	230	12050000					

IME Turbo





fig.	Vare nr.	P (W)	volt. (V)	Ref. No.	fig.	Vare nr.	P (W)	volt. (V)	Ref. No.
1	415236	400	110	205004	2	415237	533	75	205002

Inoksan



fig.	Vare nr.	P (W)	volt. (V)	Ref. No.
1	416861	290	-	24417022

Kromo



fig.	Vare nr.	P (W)	volt. (V)	Ref. No.	fig.	Vare nr.	P (W)	volt. (V)	Ref. No.
1	416174	450	75	DW8075	1	417534	500	115	DW8156

Malag



fig.	Vare nr.	P (W)	volt. (V)	Ref. No.
1	415309	400	230	12050000 (14-01)

Pieffe



fig.	Vare nr.	P (W)	volt. (V)	Ref. No.
1	415303	400	115	3303

RM-Gastro



fig.	Vare nr.	P (W)	volt. (V)	Ref. No.
1	416187	400	115	401023400
1	418625	500	110	401023500

Roller Grill

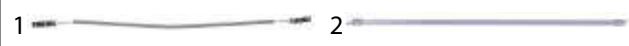



fig.	Vare nr.	P (W)	volt. (V)	Ref. No.
1	416764	100	75	D01035
2	417217	200	115	D04029
2	418820	460	76	D04033
2	420089	600	115	D04034
2	416732	750	115	D04020





fig.	Vare nr.	P (W)	volt. (V)	Ref. No.
3	416737	250	220-240	D01026
3	416761	450	115	D01003
3	416738	500	220-240	D01027
3	416729	600	230	D01021
3	416708	750	115	D01032
3	416750	1100	230	D01033
3	416758	-	-	D01031
4	418625	500	110	D04022





fig.	Vare nr.	P (W)	volt. (V)	Ref. No.
5	420460	500	115	D04043
6	416713	525	76	D04023





fig.	Vare nr.	P (W)	volt. (V)	Ref. No.
7	420459	580	115	D04040
8	416766	735	77	D01036



fig.	Vare nr.	P (W)	volt. (V)	Ref. No.
9	420461	750	115	D04038
10	416709	-	-	D04015
10	416715	-	-	D04007
10	416736	-	-	D04013
10	416753	-	-	D04011
10	416757	-	-	D04006
10	416760	-	-	D04005
10	416763	-	-	D04009



fig.	Vare nr.	P (W)	volt. (V)	Ref. No.
11	416710	-	-	D01045
11	416714	-	-	D01040

Rosinox



fig.	Vare nr.	P (W)	volt. (V)	Ref. No.
1	421000	650	230/240	RX94933597

RSI



fig.	Vare nr.	P (W)	volt. (V)	Ref. No.
1	416858	420	115	30008462

Saro



fig.	Vare nr.	P (W)	volt. (V)	Ref. No.
1	415303	400	115	122-2075

Silanos



fig.	Vare nr.	P (W)	volt. (V)	Ref. No.
1	416020	-	-	907380

Sirman



fig.	Vare nr.	P (W)	volt. (V)	Ref. No.
1	416564	400	110	IB5206800
2	416482	400	115	IGS402T04
2	416485	600	110	IGS402T06/02
2	416562	700	110	IGS402SF



fig.	Vare nr.	P (W)	volt. (V)	Ref. No.
3	417448	400	230	IB5206910
4	416483	-	-	IGS660T06
4	416486	-	-	IB3506800
4	416561	-	-	IGS660SF
4	418583	-	-	IB3506900

SSP



fig.	Vare nr.	P (W)	volt. (V)	Ref. No.
1	359630	500	230	0661301000

Star10



fig.	Vare nr.	P (W)	volt. (V)	Ref. No.	fig.	Vare nr.	P (W)	volt. (V)	Ref. No.
1	416414	500	115	—	2	416153	600	230	071051.1
2	416152	500	230	071014.1	2	418834	600	230	071051

VEGA



fig.	Vare nr.	P (W)	volt. (V)	Ref. No.	fig.	Vare nr.	P (W)	volt. (V)	Ref. No.
1	415303	400	115	92027	2	419179	700	110	93119



fig.	Vare nr.	P (W)	volt. (V)	Ref. No.
3	416020	-	-	92000

grooved tubular heating elements

EGO



fig.	Vare nr.	P (W)	volt. (V)	HC	L (mm)	W (mm)	H (mm)	Ref. No.
1	415300	1600	240	2	458	202	21	33.90000.822

Rosinox



fig.	Vare nr.	P (W)	volt. (V)	HC	L (mm)	W (mm)	H (mm)	Ref. No.
1	415300	1600	240	2	458	202	21	RX94805488



Silko



1

fig.	Vare nr.	P (W)	volt. (V)	HC	L (mm)	W (mm)	H (mm)	Ref. No.
1	415300	1600	240	2	458	202	21	SIR0101492

coil heating elements

Angelo-Po



1

fig.	Vare nr.	P (W)	volt. (V)	HC	L (mm)	W (mm)	Ref. No.
1	419164	1500	230	1	345	95	32G2200

Aristarco



1

fig.	Vare nr.	P (W)	volt. (V)	HC	L (mm)	W (mm)	Ref. No.
1	420319	2300	230	1	405	135	00005616

Colged



1

fig.	Vare nr.	P (W)	volt. (V)	HC	L (mm)	W (mm)	Ref. No.
1	420330	2000	240	1	454	210	927132

Comenda

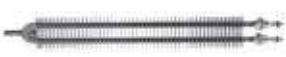

1

fig.	Vare nr.	P (W)	volt. (V)	HC	L (mm)	W (mm)	Ref. No.
1	418823	1000	230	1	405	50	110704
1	418824	1500	230	1	428	50	110706

Cookmax



1

fig.	Vare nr.	P (W)	volt. (V)	HC	L (mm)	W (mm)	Ref. No.
1	418719	1000	230	1	180	80	X02.05.620.00

Dihr



1

fig.	Vare nr.	P (W)	volt. (V)	HC	L (mm)	W (mm)	Ref. No.
1	419039	2000/2180	230/240	1	395	93	DW2000359

Elettrobar

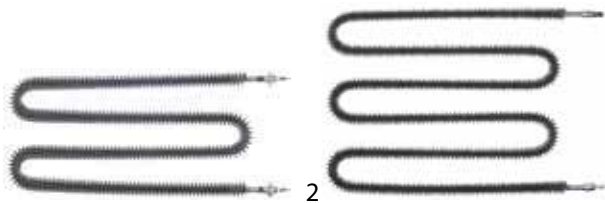

1 2

fig.	Vare nr.	P (W)	volt. (V)	HC	L (mm)	W (mm)	Ref. No.
1	420330	2000	240	1	454	210	927132
2	417526	4000	220	1	475	350	DRE1

Elframo



1

fig.	Vare nr.	P (W)	volt. (V)	HC	L (mm)	W (mm)	Ref. No.
1	420345	1400	230	1	285	135	00055600

Fagor



1

fig.	Vare nr.	P (W)	volt. (V)	HC	L (mm)	W (mm)	Ref. No.
1	418969	1500	230	1	455	50	12024856

Hatco



1

fig.	Vare nr.	P (W)	volt. (V)	HC	L (mm)	W (mm)	Ref. No.
1	418719	1000	230	1	180	80	X02.05.620.00

Hoonved

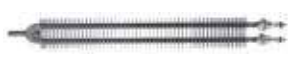

1

fig.	Vare nr.	P (W)	volt. (V)	HC	L (mm)	W (mm)	Ref. No.
1	418823	1000	230	1	405	50	H110704
1	418824	1500	230	1	428	50	H110706



Komel



fig.	Vare nr.	P (W)	volt. (V)	HC	L (mm)	W (mm)	Ref. No.
1	420345	1400	230	1	285	135	00055600

Kromo

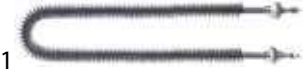

fig.	Vare nr.	P (W)	volt. (V)	HC	L (mm)	W (mm)	Ref. No.
1	419039	2000/2180	230/240	1	395	93	DW2000359

Lamber

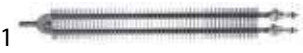

fig.	Vare nr.	P (W)	volt. (V)	HC	L (mm)	W (mm)	Ref. No.
1	418823	1000	230	1	405	50	0303100

MIWE



fig.	Vare nr.	P (W)	volt. (V)	HC	L (mm)	W (mm)	Ref. No.
1	420285	1000	230	1	285	70	060004.11
1	420286	1500	230	1	285	70	060004.00

Morice



fig.	Vare nr.	P (W)	volt. (V)	HC	L (mm)	W (mm)	Ref. No.
1	418393	500	230	1	305	50	RS0880
1	418395	1000	230	1	513	50	RS0881
1	418396	1500	230	1	748	50	RS0892

Olis



fig.	Vare nr.	P (W)	volt. (V)	HC	L (mm)	W (mm)	Ref. No.
1	419039	2000/2180	230/240	1	395	93	2000359

Rosinox

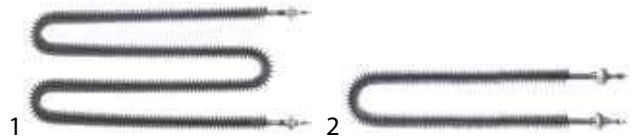

fig.	Vare nr.	P (W)	volt. (V)	HC	L (mm)	W (mm)	Ref. No.
1	420330	2000	240	1	454	210	RX94803905
2	419039	2000/2180	230/240	1	395	93	RX94808623

Silanos



fig.	Vare nr.	P (W)	volt. (V)	HC	L (mm)	W (mm)	Ref. No.
1	419164	1500	230	1	345	95	TR0360
1	416328	2000	230	1	345	96	TR0359

SSP



fig.	Vare nr.	P (W)	volt. (V)	HC	L (mm)	W (mm)	Ref. No.
1	418593	1200	230	1	305	50	0617303100

immersion heating elements

Adler



fig.	Vare nr.	P (W)	volt. (V)	HC	L (mm)	W (mm)	Ref. No.
1	415909	2000	230	1	243	34	20556
2	415185	2000	230	1	270	26	20070



fig.	Vare nr.	P (W)	volt. (V)	HC	L (mm)	W (mm)	Ref. No.
3	416022	2000	230	1	305	36	20504
4	415188	2400	230	2	248	33	20069



fig.	Vare nr.	P (W)	volt. (V)	HC	L (mm)	W (mm)	Ref. No.
5	415187	2800	230	1	255	38	20088
6	415189	2800	230	1	340	15	20072





fig.	Vare nr.	P (W)	volt. (V)	HC	L (mm)	W (mm)	Ref. No.
7	415186	4000	230	3	315	39	20075
8	415190	6000	230	3	340	34	20080
8	416023	9000	230	3	395	37	20084

Alpeninox



fig.	Vare nr.	P (W)	volt. (V)	HC	L (mm)	W (mm)	Ref. No.
1	415598	4500	230	3	350	28	046623

Ambach



fig.	Vare nr.	P (W)	volt. (V)	HC	L (mm)	W (mm)	Ref. No.
1	415674	4500	230	3	395	30	5060810063
1	415849	15000	230	3	530	45	R65020420
2	415773	6000	230	3	390	31	5060810064
2	415854	8000	230	3	385	32	5060809979



fig.	Vare nr.	P (W)	volt. (V)	HC	L (mm)	W (mm)	Ref. No.
3	415848	7500	230	3	365	36	R65020350

Ambassade

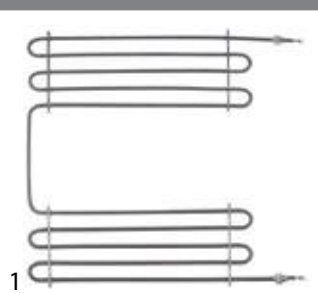

fig.	Vare nr.	P (W)	volt. (V)	HC	L (mm)	W (mm)	Ref. No.
1	420465	2000	230	1	403	420	6539052

Angelo-Po



fig.	Vare nr.	P (W)	volt. (V)	HC	L (mm)	W (mm)	Ref. No.
1	415249	1500	220	1	220	36	—
2	415268	1850	230	1	245	40	—
2	415270	2700	230	1	335	43	32g3360



fig.	Vare nr.	P (W)	volt. (V)	HC	L (mm)	W (mm)	Ref. No.
3	416209	2000	230	1	180	90	32G2070
4	415013	2400	230	1	215	40	32G0790



fig.	Vare nr.	P (W)	volt. (V)	HC	L (mm)	W (mm)	Ref. No.
5	415043	2500	230	1	225	41	32g0540
5	415019	3000	230	3	338	37	—
5	415021	6000	230	3	343	37	32G0400
6	415269	2700	230	3	257	28	32G3400



fig.	Vare nr.	P (W)	volt. (V)	HC	L (mm)	W (mm)	Ref. No.
7	416277	2800	230	1	302	37	—
8	415011	3000	230	1	285	24	32g0500



fig.	Vare nr.	P (W)	volt. (V)	HC	L (mm)	W (mm)	Ref. No.
9	416261	3000	230	1	358	32	32G2590
10	417167	4500	230	3	300	37	32G0170



fig.	Vare nr.	P (W)	volt. (V)	HC	L (mm)	W (mm)	Ref. No.
11	416267	4500	230	3	358	32	32G2140
11	416268	6000	230	3	360	34	—
11	416269	8000	230	3	545	32	32G2170
12	415263	4500	230	3	375	38	—



fig.	Vare nr.	P (W)	volt. (V)	HC	L (mm)	W (mm)	Ref. No.
13	416599	7000	240	3	405	42	32G1160
13	416600	7000	400	3	415	41	32G2330
14	415265	9000	230	3	470	35	32G3410



fig.	Vare nr.	P (W)	volt. (V)	HC	L (mm)	W (mm)	Ref. No.
15	418586	9000	230	3	515	37	32G2720
16	415022	9000	230/400	3	475	36	32G0850
16	415023	12500	230	3	630	36	—



17





fig.	Vare nr.	P (W)	volt. (V)	HC	L (mm)	W (mm)	Ref. No.
17	419138	14000	230	3	515	37	32G2840

Aristarco

1



2





fig.	Vare nr.	P (W)	volt. (V)	HC	L (mm)	W (mm)	Ref. No.
1	416244	1000	230	1	258	34	00000386
1	415145	1500	230	1	254	36	00001350
1	416247	2000	230	1	264	38	00002114
2	415671	1500	230	1	290	40	00000200
2	416248	2000	230	1	335	40	00006445

3



4



fig.	Vare nr.	P (W)	volt. (V)	HC	L (mm)	W (mm)	Ref. No.
3	415144	2000	230	1	162	30	00000312
4	420269	2500	230	1	185	45	00001323

5



fig.	Vare nr.	P (W)	volt. (V)	HC	L (mm)	W (mm)	Ref. No.
5	418711	3000	230	1	285	42	00001294

Ascobloc

1





fig.	Vare nr.	P (W)	volt. (V)	HC	L (mm)	W (mm)	Ref. No.
1	415405	6000	230	3	465	38	9294203

ATA

1



2





fig.	Vare nr.	P (W)	volt. (V)	HC	L (mm)	W (mm)	Ref. No.
1	415249	1500	220	1	220	36	7609
2	415330	1500	230	1	310	36	1102
2	416127	1800	230	1	318	36	6816

3



4



fig.	Vare nr.	P (W)	volt. (V)	HC	L (mm)	W (mm)	Ref. No.
3	415248	2000	230	1	415	32	4360
4	415042	2200	230	1	165	35	1020

5



6



fig.	Vare nr.	P (W)	volt. (V)	HC	L (mm)	W (mm)	Ref. No.
5	415043	2500	230	1	225	41	7204
5	415021	6000	230	3	343	37	6201
6	415044	3000	230	3	270	37	4205

7



8





fig.	Vare nr.	P (W)	volt. (V)	HC	L (mm)	W (mm)	Ref. No.
7	415045	4500	230	3	372	38	5205
7	416029	6000	230	3	490	36	6205
8	415808	6500	230	3	375	38	5505
8	420343	9000	220	3	535	37	6605
8	420344	9840	220	3	495	37	9699

Baron

1



2



fig.	Vare nr.	P (W)	volt. (V)	HC	L (mm)	W (mm)	Ref. No.
1	420074	260	230	1	242	18	CR0682160
2	415269	2700	230	3	257	28	BN01120288520

3



4



fig.	Vare nr.	P (W)	volt. (V)	HC	L (mm)	W (mm)	Ref. No.
3	418040	6000	230	3	385	32	BN41853310062
3	418041	8000	230	3	470	42	BN41853310185
4	418111	7500	220	6	310	145	0A037483
4	418112	15000	220	6	310	230	BN6A037484

5



fig.	Vare nr.	P (W)	volt. (V)	HC	L (mm)	W (mm)	Ref. No.
5	416279	12000	230	3	470	48	BN011DW30001011/A



Bartscher

fig.	Vare nr.	P (W)	volt. (V)	HC	L (mm)	W (mm)	Ref. No.
1	416234	600	230	1	160	45	—
2	415005	2000	230	1	170	32	012290

fig.	Vare nr.	P (W)	volt. (V)	HC	L (mm)	W (mm)	Ref. No.
3	415664	2250	230	1	300	90	011598
4	415668	2625	230	1	190	41	0230090
4	416235	3000	230	1	320	50	080360

fig.	Vare nr.	P (W)	volt. (V)	HC	L (mm)	W (mm)	Ref. No.
5	415001	4500	230	3	316	35	0230081
6	415190	6000	230	3	340	34	0481925928596

fig.	Vare nr.	P (W)	volt. (V)	HC	L (mm)	W (mm)	Ref. No.
7	415665	2750/3250	220/240	1	380	110	017677

Baumeister

fig.	Vare nr.	P (W)	volt. (V)	HC	L (mm)	W (mm)	Ref. No.
1	415801	2000	230	1	321	44	733020

Bertos

fig.	Vare nr.	P (W)	volt. (V)	HC	L (mm)	W (mm)	Ref. No.
1	418137	3000	230	1	220	65	10622
2	418136	4360	240	3	310	31	25021600

fig.	Vare nr.	P (W)	volt. (V)	HC	L (mm)	W (mm)	Ref. No.
3	418064	8000	230	3	497	30	35039900
3	418065	9000	230	1	415	36	35040100

Blanco

fig.	Vare nr.	P (W)	volt. (V)	HC	L (mm)	W (mm)	Ref. No.
1	415636	2000	230	1	260	102	—

Blumauer

fig.	Vare nr.	P (W)	volt. (V)	HC	L (mm)	W (mm)	Ref. No.
1	415582	5000	230	3	345	36	00180362

Bonnet

fig.	Vare nr.	P (W)	volt. (V)	HC	L (mm)	W (mm)	Ref. No.
1	415005	2000	230	1	170	32	3696E
2	415010	2000	230	1	260	125	5514E

fig.	Vare nr.	P (W)	volt. (V)	HC	L (mm)	W (mm)	Ref. No.
3	418932	2000	240	1	350	30	71244E
4	415072	2200	230	1	325	83	5065E
4	415664	2250	230	1	300	90	5514E

fig.	Vare nr.	P (W)	volt. (V)	HC	L (mm)	W (mm)	Ref. No.
5	418709	2400	230	1	190	32	5535E
5	415668	2625	230	1	190	41	5536E
6	418642	2600	230	1	260	33	2001621H





fig.	Vare nr.	P (W)	volt. (V)	HC	L (mm)	W (mm)	Ref. No.
7	415016	3000	230	3	398	60	903101
8	416128	4500	230	3	265	30	5079E



fig.	Vare nr.	P (W)	volt. (V)	HC	L (mm)	W (mm)	Ref. No.
9	415001	4500	230	3	316	35	5845E
10	418923	6000	230	3	493	36	1030210

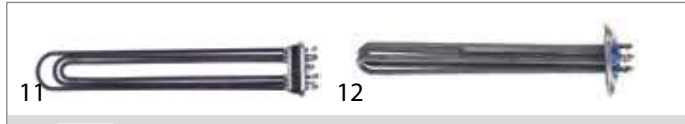

fig.	Vare nr.	P (W)	volt. (V)	HC	L (mm)	W (mm)	Ref. No.
11	416243	7600	230	3	390	60	2001624H
12	416242	9500	230	3	330	35	2001941H

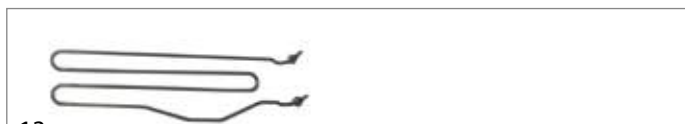

fig.	Vare nr.	P (W)	volt. (V)	HC	L (mm)	W (mm)	Ref. No.
13	415665	2750/3250	220/240	1	380	110	5856E

Bourgeois

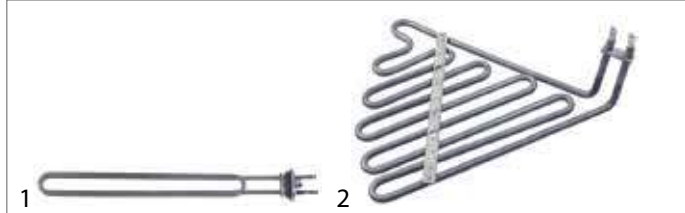

fig.	Vare nr.	P (W)	volt. (V)	HC	L (mm)	W (mm)	Ref. No.
1	418932	2000	240	1	350	30	RC553
2	420188	3000	230	1	350	300	RC3027



fig.	Vare nr.	P (W)	volt. (V)	HC	L (mm)	W (mm)	Ref. No.
3	416502	8000	240	3	305	40	RC802
4	420268	9000	240	6	135	75	RC2028
4	420203	12000	240	6	165	74	RC2029



fig.	Vare nr.	P (W)	volt. (V)	HC	L (mm)	W (mm)	Ref. No.
5	420201	9000	240	6	135	78	RC2033
6	420200	12000	240	6	155	78	RC2035

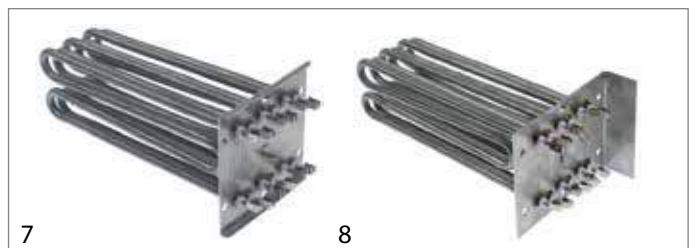

fig.	Vare nr.	P (W)	volt. (V)	HC	L (mm)	W (mm)	Ref. No.
7	420202	18000	240	6	229	78	RC2034
8	420199	18000	240	6	235	78	RC2032

Capic

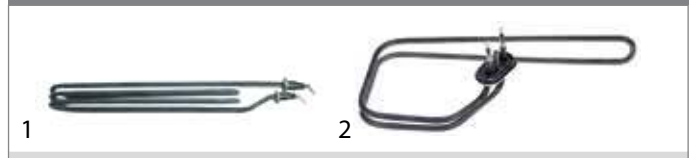

fig.	Vare nr.	P (W)	volt. (V)	HC	L (mm)	W (mm)	Ref. No.
1	415156	2500	230	1	255	42	L201050
2	415151	2500	230	1	273	130	L201035



fig.	Vare nr.	P (W)	volt. (V)	HC	L (mm)	W (mm)	Ref. No.
3	415154	2500	230	1	455	37	L201030
4	415159	2500	230	2	285	65	L201045



fig.	Vare nr.	P (W)	volt. (V)	HC	L (mm)	W (mm)	Ref. No.
5	415035	3000	230	3	207	40	L201005
6	415846	4000	230	3	327	36	L202015
6	415038	5000	230	3	373	44	L202022



fig.	Vare nr.	P (W)	volt. (V)	HC	L (mm)	W (mm)	Ref. No.
7	418846	4500	230	3	395	37	E153010 E153010

Charvet

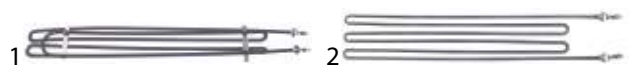

fig.	Vare nr.	P (W)	volt. (V)	HC	L (mm)	W (mm)	Ref. No.
1	420231	3000	230	1	665	90	03345A
2	420232	3500	230	1	665	110	03346A

Classeq



fig.	Vare nr.	P (W)	volt. (V)	HC	L (mm)	W (mm)	Ref. No.
1	419194	6000	230	3	285	32	30000972
2	416214	6000	230	3	410	32	HY306

Colged



fig.	Vare nr.	P (W)	volt. (V)	HC	L (mm)	W (mm)	Ref. No.
1	420332	600	230	1	125	48	230107
2	416234	600	230	1	160	45	230098

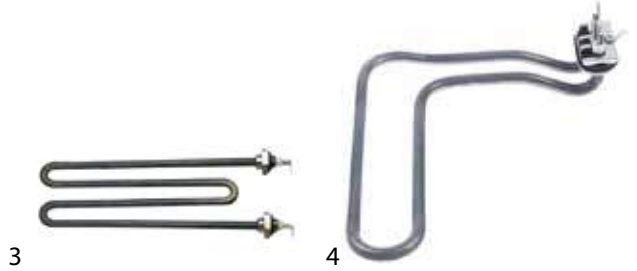

fig.	Vare nr.	P (W)	volt. (V)	HC	L (mm)	W (mm)	Ref. No.
3	415666	1100	230	1	151	56	230077
4	420331	1400	230	1	160	190	230112



fig.	Vare nr.	P (W)	volt. (V)	HC	L (mm)	W (mm)	Ref. No.
5	415041	1500	230	1	150	26	—
6	415664	2250	230	1	300	90	230085

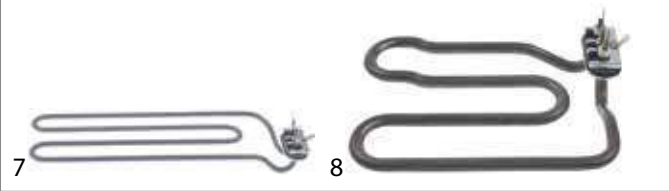

fig.	Vare nr.	P (W)	volt. (V)	HC	L (mm)	W (mm)	Ref. No.
7	420333	2450	220/240	1	295	89	230103
8	420464	2500	230	1	170	120	73069



fig.	Vare nr.	P (W)	volt. (V)	HC	L (mm)	W (mm)	Ref. No.
9	415156	2500	230	1	255	42	DRV23
10	415151	2500	230	1	273	130	926217

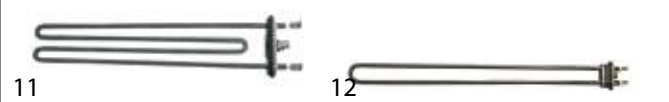

fig.	Vare nr.	P (W)	volt. (V)	HC	L (mm)	W (mm)	Ref. No.
11	415009	2500	230	1	280	51	230087
12	415154	2500	230	1	455	37	DRV15



fig.	Vare nr.	P (W)	volt. (V)	HC	L (mm)	W (mm)	Ref. No.
13	415159	2500	230	2	285	65	DRV24
14	415034	2600	230	1	180	37	DRB23



fig.	Vare nr.	P (W)	volt. (V)	HC	L (mm)	W (mm)	Ref. No.
15	416239	2600	230	1	270	65	230100
16	415668	2625	230	1	190	41	230090
16	416235	3000	230	1	320	50	80360

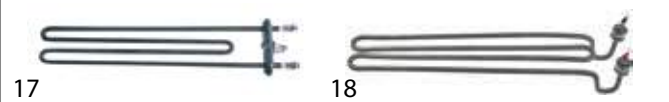

fig.	Vare nr.	P (W)	volt. (V)	HC	L (mm)	W (mm)	Ref. No.
17	415000	2900	230	1	272	51	230088
18	420463	3000	230	1	325	55	70562

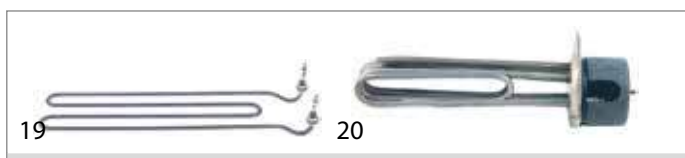

fig.	Vare nr.	P (W)	volt. (V)	HC	L (mm)	W (mm)	Ref. No.
19	420334	3000	230	1	380	87	41211
20	415035	3000	230	3	207	40	DRB32



fig.	Vare nr.	P (W)	volt. (V)	HC	L (mm)	W (mm)	Ref. No.
21	415846	4000	230	3	327	36	DRB41
21	415038	5000	230	3	373	44	DRB51
22	415155	4500	230	3	170	59	—



fig.	Vare nr.	P (W)	volt. (V)	HC	L (mm)	W (mm)	Ref. No.
23	415001	4500	230	3	316	35	230034
24	416240	6545	230	3	355	31	230083
24	416241	8000	230	3	355	35	230020



fig.	Vare nr.	P (W)	volt. (V)	HC	L (mm)	W (mm)	Ref. No.
25	419042	7000	230	3	415	64	230108
26	416243	7600	230	3	390	60	230106

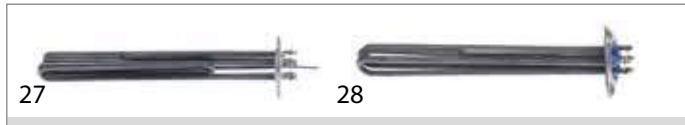

fig.	Vare nr.	P (W)	volt. (V)	HC	L (mm)	W (mm)	Ref. No.
27	415039	8000	230	3	375	41	—
27	418871	10000	230	3	375	40	DRB100C
28	416242	9500	230	3	330	35	80398

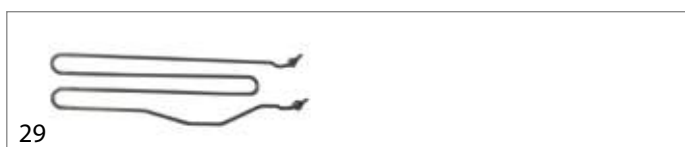

fig.	Vare nr.	P (W)	volt. (V)	HC	L (mm)	W (mm)	Ref. No.
29	415665	2750/3250	220/240	1	380	110	230086

Comenda



fig.	Vare nr.	P (W)	volt. (V)	HC	L (mm)	W (mm)	Ref. No.
1	416270	500	230	1	225	95	110271
2	415062	1275	230	1	147	103	110260



fig.	Vare nr.	P (W)	volt. (V)	HC	L (mm)	W (mm)	Ref. No.
3	415015	1500	230	1	212	68	110228
4	415012	1500	230	1	225	120	110235

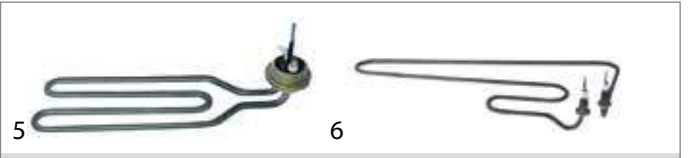

fig.	Vare nr.	P (W)	volt. (V)	HC	L (mm)	W (mm)	Ref. No.
5	415017	1500	230	1	295	92	110208
6	415756	2000	230	1	137	355	110263

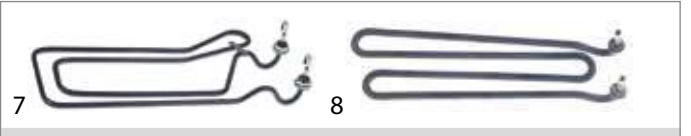

fig.	Vare nr.	P (W)	volt. (V)	HC	L (mm)	W (mm)	Ref. No.
7	416389	2000	230	1	163	290	—
8	415198	2000	230	1	318	85	—



fig.	Vare nr.	P (W)	volt. (V)	HC	L (mm)	W (mm)	Ref. No.
9	416275	2200	230	1	235	38	110361
9	415060	3000	230	1	330	45	110363
10	415013	2400	230	1	215	40	110364

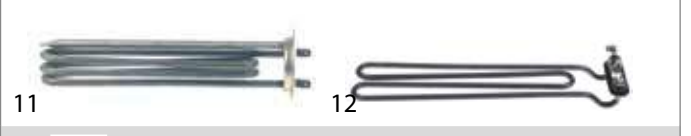

fig.	Vare nr.	P (W)	volt. (V)	HC	L (mm)	W (mm)	Ref. No.
11	416272	2400	230	1	220	35	110262
12	415061	2400	230	1	383	83	110373





fig.	Vare nr.	P (W)	volt. (V)	HC	L (mm)	W (mm)	Ref. No.
13	415014	3000	230	1	240	28	110366
14	415019	3000	230	3	338	37	110226
14	415021	6000	230	3	343	37	110349



fig.	Vare nr.	P (W)	volt. (V)	HC	L (mm)	W (mm)	Ref. No.
15	415016	3000	230	3	398	60	110227
16	420339	3000	254	3	395	61	110232



fig.	Vare nr.	P (W)	volt. (V)	HC	L (mm)	W (mm)	Ref. No.
17	416273	3200	230	1	237	35	110397
18	416274	5000	230	3	248	36	110398



fig.	Vare nr.	P (W)	volt. (V)	HC	L (mm)	W (mm)	Ref. No.
19	418895	5000	230	3	350	35	110332
20	420340	6000	254/440	3	410	36	110354



fig.	Vare nr.	P (W)	volt. (V)	HC	L (mm)	W (mm)	Ref. No.
21	418891	7000	230	3	350	25	110333
22	415670	8000	230	3	480	40	110343
22	415022	9000	230/400	3	475	36	110362
22	418624	10000	230/400	3	480	35	110388
22	415023	12500	230	3	630	36	110367
22	417554	12500	254/440	3	6150	50	110381
22	420159	14000	230/400	3	500	36	110392
22	420342	14000	230/400	3	620	33	110386

Convotherm



fig.	Vare nr.	P (W)	volt. (V)	HC	L (mm)	W (mm)	Ref. No.
1	415803	6000	230	3	325	26	5007062K
2	420043	6600	230	3	275	65	2619178
2	417601	6600	230	3	275	70	2619187



fig.	Vare nr.	P (W)	volt. (V)	HC	L (mm)	W (mm)	Ref. No.
3	415500	7500	220	3	425	33	5007063K
3	415501	9000	230	3	430	32	5007066K
4	415802	9000	230	3	385	35	5007071K

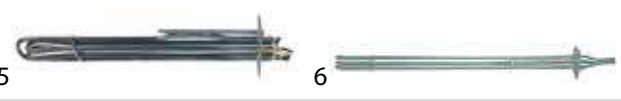

fig.	Vare nr.	P (W)	volt. (V)	HC	L (mm)	W (mm)	Ref. No.
5	418685	9900	230	3	415	65	2619179
6	415931	12000	220	3	585	28	5007076K



fig.	Vare nr.	P (W)	volt. (V)	HC	L (mm)	W (mm)	Ref. No.
7	420042	13200	230	3	545	65	2619180
8	415874	12000/14300	220/240	3	585	40	5007068K

Cookmax



fig.	Vare nr.	P (W)	volt. (V)	HC	L (mm)	W (mm)	Ref. No.
1	416234	600	230	1	160	45	230098
2	418642	2600	230	1	260	33	230113



fig.	Vare nr.	P (W)	volt. (V)	HC	L (mm)	W (mm)	Ref. No.
3	415000	2900	230	1	272	51	230088
4	416235	3000	230	1	320	50	80360



fig.	Vare nr.	P (W)	volt. (V)	HC	L (mm)	W (mm)	Ref. No.
5	415001	4500	230	3	316	35	230081
6	418714	6000	230	3	385	37	6A037190



fig.	Vare nr.	P (W)	volt. (V)	HC	L (mm)	W (mm)	Ref. No.
7	416241	8000	230	3	355	35	230020
8	415665	2750/3250	220/240	1	380	110	230086



Dihr

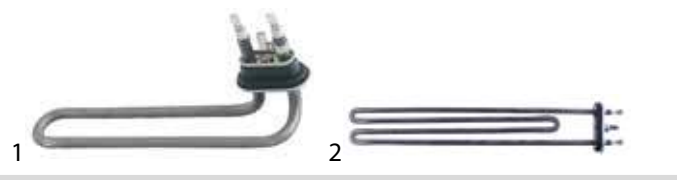

fig.	Vare nr.	P (W)	volt. (V)	HC	L (mm)	W (mm)	Ref. No.
1	416276	1100	230	1	203	40	DW540401
2	415267	1800	230	1	190	41	DW17201
2	415266	2000	230	1	300	41	DW10714



fig.	Vare nr.	P (W)	volt. (V)	HC	L (mm)	W (mm)	Ref. No.
3	415268	1850	230	1	245	40	DW16035/A
3	415270	2700	230	1	335	43	DW150047
4	415261	2400	230	1	242	31	DW18206



fig.	Vare nr.	P (W)	volt. (V)	HC	L (mm)	W (mm)	Ref. No.
5	415260	2500	230	1	185	40	DW16036/A
6	415269	2700	230	3	257	28	DW15047

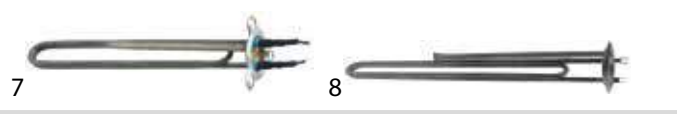

fig.	Vare nr.	P (W)	volt. (V)	HC	L (mm)	W (mm)	Ref. No.
7	416277	2800	230	1	302	37	DW18206/D
8	420056	2800	230	1	380	34	DW15089/D



fig.	Vare nr.	P (W)	volt. (V)	HC	L (mm)	W (mm)	Ref. No.
9	415262	3000	230	3	260	40	DW15046
10	416398	4000	230	3	287	26	DW18215

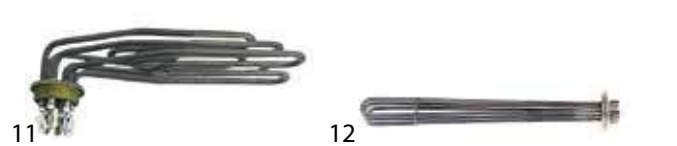

fig.	Vare nr.	P (W)	volt. (V)	HC	L (mm)	W (mm)	Ref. No.
11	415271	4500	230	3	88	285	DW10300022
12	415263	4500	230	3	375	38	DW15089



fig.	Vare nr.	P (W)	volt. (V)	HC	L (mm)	W (mm)	Ref. No.
13	420359	6000	230	3	275	32	DW590121
14	416278	6000	230	3	435	38	DW15089/A
14	415264	6000	230	3	480	33	DW30001010
14	416279	12000	230	3	470	48	DW30001011/A
14	420055	14000	230	3	480	36	DW30001011/B



fig.	Vare nr.	P (W)	volt. (V)	HC	L (mm)	W (mm)	Ref. No.
15	415265	9000	230	3	470	35	DW30001011
16	419191	3000-3270	230-240	3	195	35	DW10300011



fig.	Vare nr.	P (W)	volt. (V)	HC	L (mm)	W (mm)	Ref. No.
17	419040	6000/6530	230/240	3	375	38	DW15089/E

Ecomax



fig.	Vare nr.	P (W)	volt. (V)	HC	L (mm)	W (mm)	Ref. No.
1	420071	2000	240	1	320	36	01-240766-101
2	417517	3000	254	1	420	70	883423-1



fig.	Vare nr.	P (W)	volt. (V)	HC	L (mm)	W (mm)	Ref. No.
3	420302	6000	240	3	325	33	01-240761-1
4	419005	7260	250	3	375	31	01-240135-2

EGO

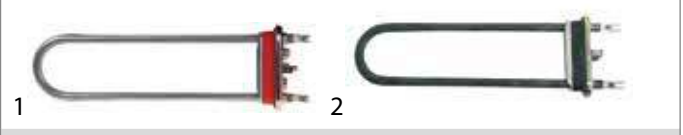

fig.	Vare nr.	P (W)	volt. (V)	HC	L (mm)	W (mm)	Ref. No.
1	415568	800	230	1	220	66	20.40631.000
2	415460	1000	230	1	230	65	20.40488.000 20.40631.010





fig.	Vare nr.	P (W)	volt. (V)	HC	L (mm)	W (mm)	Ref. No.
3	415507	2000	230	1	250	35	20.40022.000
4	415801	2000	230	1	321	44	20.40246.000



fig.	Vare nr.	P (W)	volt. (V)	HC	L (mm)	W (mm)	Ref. No.
5	416239	2600	230	1	270	65	20.40307.000
6	418795	3000	230	1	300	70	20.28642.010



fig.	Vare nr.	P (W)	volt. (V)	HC	L (mm)	W (mm)	Ref. No.
7	415465	3000	230	2	365	65	20.40423.030
7	415552	3000	400	2	365	64	20.40423.020
7	415466	6000	230	2	365	65	20.40423.010
7	415447	6000	230	2	375	65	20.40440.000
7	415551	6000	400	2	365	65	20.40423.000
7	415448	6000	400	2	370	65	20.40440.010
8	415411	3000	230	3	265	39	24.22186.000



fig.	Vare nr.	P (W)	volt. (V)	HC	L (mm)	W (mm)	Ref. No.
9	415406	3000	230	3	270	35	24.22181.010
10	420365	3600	230	3	270	38	20.27387.000



fig.	Vare nr.	P (W)	volt. (V)	HC	L (mm)	W (mm)	Ref. No.
11	415412	4500	230	3	394	36	24.22187.000
12	415569	5000	230	2	272	65	20.40632.010
12	419053	5000	400	2	272	65	20.40632.000
12	415459	5600	230	2	272	64	20.40632.040
12	415557	5600	400	2	272	64	20.40632.030



fig.	Vare nr.	P (W)	volt. (V)	HC	L (mm)	W (mm)	Ref. No.
13	415663	6000	230	3	400	40	20.28139.000
14	415408	6000	230	3	500	37	24.22183.010



fig.	Vare nr.	P (W)	volt. (V)	HC	L (mm)	W (mm)	Ref. No.
15	415692	9000	230	3	485	34	20.30034.000
16	418270	9000	230	3	535	36	20.29335.000



fig.	Vare nr.	P (W)	volt. (V)	HC	L (mm)	W (mm)	Ref. No.
17	418287	9000	230	3	540	37	20.29496.000
17	415888	12000	230	3	510	34	20.27512.000

Electrolux



fig.	Vare nr.	P (W)	volt. (V)	HC	L (mm)	W (mm)	Ref. No.
1	415455	450	230	1	242	18.5	0K0604
2	415272	800	230	1	160	34	049059

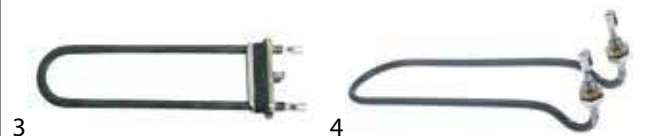

fig.	Vare nr.	P (W)	volt. (V)	HC	L (mm)	W (mm)	Ref. No.
3	415460	1000	230	1	230	65	0H6199
4	419166	1400	230	1	235	50	0PRF12

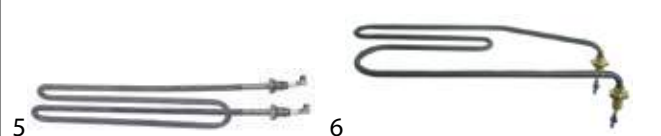

fig.	Vare nr.	P (W)	volt. (V)	HC	L (mm)	W (mm)	Ref. No.
5	415909	2000	230	1	243	34	0HA117
6	415010	2000	230	1	260	125	069671

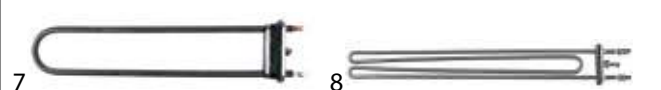

fig.	Vare nr.	P (W)	volt. (V)	HC	L (mm)	W (mm)	Ref. No.
7	418648	2000	230	1	325	65	049755
8	417539	2000	230	1	350	41.4	0E2326



fig.	Vare nr.	P (W)	volt. (V)	HC	L (mm)	W (mm)	Ref. No.
9	416133	2000	230	1	365	80	0L2109
10	415073	2200	220	1	403	138	047507



fig.	Vare nr.	P (W)	volt. (V)	HC	L (mm)	W (mm)	Ref. No.
11	415072	2200	230	1	325	83	048086
12	415070	2200	230	1	355	75	0L2340



fig.	Vare nr.	P (W)	volt. (V)	HC	L (mm)	W (mm)	Ref. No.
13	415188	2400	230	2	248	33	070307
14	420279	2500	240	1	290	39	0W1W03



fig.	Vare nr.	P (W)	volt. (V)	HC	L (mm)	W (mm)	Ref. No.
15	415668	2625	230	1	190	41	0K3789
15	415002	3000	230	1	198	35	069455
15	418825	3000	230	1	310	68	049756
16	416130	2800	230	1	310	8.5	049371
16	416135	2800	230	1	375	8.5	049980



fig.	Vare nr.	P (W)	volt. (V)	HC	L (mm)	W (mm)	Ref. No.
17	416132	3000	230	1	360	70	0L1870
18	415174	3000	230	3	160	33	0L1634

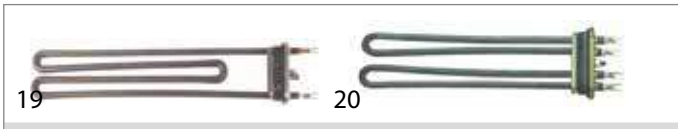

fig.	Vare nr.	P (W)	volt. (V)	HC	L (mm)	W (mm)	Ref. No.
19	420054	3500	230	1	310	68	049757
20	415461	4000	230	2	237	64	0H6170
20	415462	4000	400	2	256	65	0H6202
20	415463	6000	230	2	385	59	0H6171
20	415464	6000	400	2	380	65	0H6198



fig.	Vare nr.	P (W)	volt. (V)	HC	L (mm)	W (mm)	Ref. No.
21	415067	4500	230	3	218	34	048928
21	420078	4500	230	3	265	32	0L2652
22	416128	4500	230	3	265	30	049955
22	416129	6000	230	3	330	36	0L2108



fig.	Vare nr.	P (W)	volt. (V)	HC	L (mm)	W (mm)	Ref. No.
23	415066	4500	230	3	310	30	0L1849
23	415080	6000	220	3	310	35	0L1878
24	415401	4500	230	3	315	33	0700214119

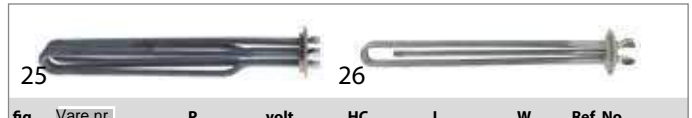

fig.	Vare nr.	P (W)	volt. (V)	HC	L (mm)	W (mm)	Ref. No.
25	418782	4500	230	3	330	43	0K4734
26	415598	4500	230	3	350	28	046623



fig.	Vare nr.	P (W)	volt. (V)	HC	L (mm)	W (mm)	Ref. No.
27	420335	4500	230	3	375	32	048284
28	418189	4700	230	3	393	40	002524



fig.	Vare nr.	P (W)	volt. (V)	HC	L (mm)	W (mm)	Ref. No.
29	420141	5000	230	1	116	79	0K8600
30	415459	5600	230	2	272	64	0H6146
30	415557	5600	400	2	272	64	0H6164



fig.	Vare nr.	P (W)	volt. (V)	HC	L (mm)	W (mm)	Ref. No.
31	420080	6000	230	3	340	36	0L1006
32	415068	6000	230	3	370	32	048513



fig.	Vare nr.	P (W)	volt. (V)	HC	L (mm)	W (mm)	Ref. No.
33	420316	6000	230	3	463	40	0L1834
34	415405	6000	230	3	465	38	0L1879



fig.	Vare nr.	P (W)	volt. (V)	HC	L (mm)	W (mm)	Ref. No.
35	415379	6000	230	3	479	36	0L1877
36	415392	6000	400	3	405	36	0K0548

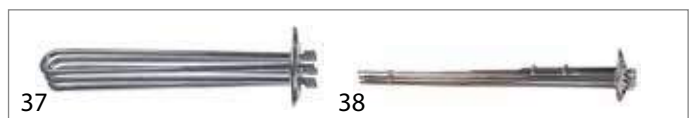

fig.	Vare nr.	P (W)	volt. (V)	HC	L (mm)	W (mm)	Ref. No.
37	420309	7000	230	3	315	37	0L2766
38	418126	7500	220	3	550	37	059665





fig.	Vare nr.	P (W)	volt. (V)	HC	L (mm)	W (mm)	Ref. No.
39	418615	7500	230	3	440	35	0L1859
39	420306	9000	230	3	450	34	0L1860
39	419132	12000	230	3	460	35	0L1861
39	420315	12000	230	3	480	36	0K8506
39	420317	15000	230	3	480	32	0K8505
40	415394	7900	230	3	287	33	058666



fig.	Vare nr.	P (W)	volt. (V)	HC	L (mm)	W (mm)	Ref. No.
41	420318	8000	220	3	475	56	047155
42	420310	8000	230	3	384	32	0L1851



fig.	Vare nr.	P (W)	volt. (V)	HC	L (mm)	W (mm)	Ref. No.
43	420312	8000	230	3	455	40	0L1835
43	420313	10000	230	3	455	44	0L1836
44	415690	9000	230	3	290	32	002835



fig.	Vare nr.	P (W)	volt. (V)	HC	L (mm)	W (mm)	Ref. No.
45	418779	9000	230	3	340	52	0L1630
46	415404	9000	230	3	600	39	214067



fig.	Vare nr.	P (W)	volt. (V)	HC	L (mm)	W (mm)	Ref. No.
47	420308	10500	230	3	245	50	0L2759
48	416134	10500	230	3	335	52	0L1772



fig.	Vare nr.	P (W)	volt. (V)	HC	L (mm)	W (mm)	Ref. No.
49	418683	10500	230	3	390	35	0L1852
50	418017	10750	230	3	542	35	0C0715



fig.	Vare nr.	P (W)	volt. (V)	HC	L (mm)	W (mm)	Ref. No.
51	419021	12000	230	3	460	44	0L1837
52	420311	12000	230	3	464	32	0L0019
52	420314	12000	230	3	464	32	0L1853



fig.	Vare nr.	P (W)	volt. (V)	HC	L (mm)	W (mm)	Ref. No.
53	416975	15000	400	6	263	240	0K0516
53	415797	18000	400	6	325	240	0K0517
53	415799	25200	400	6	470	235	0H6153
54	415063	17000	230	3	590	29	0C5336



fig.	Vare nr.	P (W)	volt. (V)	HC	L (mm)	W (mm)	Ref. No.
55	420305	17000	400	6	395	76	0C5840
55	420284	24000	400	6	535	60	0C5841
56	418154	17000	400	6	450	39	0C5384
56	418155	24000	400	6	570	40	0C5383



fig.	Vare nr.	P (W)	volt. (V)	HC	L (mm)	W (mm)	Ref. No.
57	415652	24000	400	6	585	32	0C5337

Elettrobar



fig.	Vare nr.	P (W)	volt. (V)	HC	L (mm)	W (mm)	Ref. No.
1	420332	600	230	1	125	48	230107
2	416234	600	230	1	160	45	230098

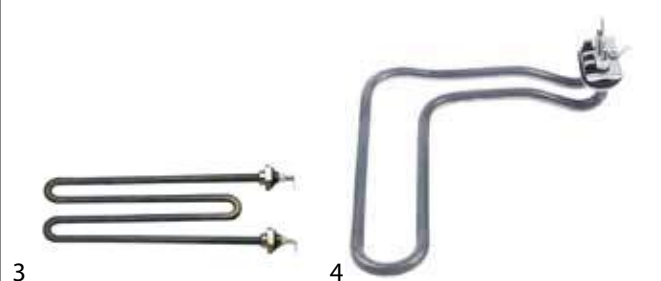

fig.	Vare nr.	P (W)	volt. (V)	HC	L (mm)	W (mm)	Ref. No.
3	415666	1100	230	1	151	56	230077
4	420331	1400	230	1	160	190	230112

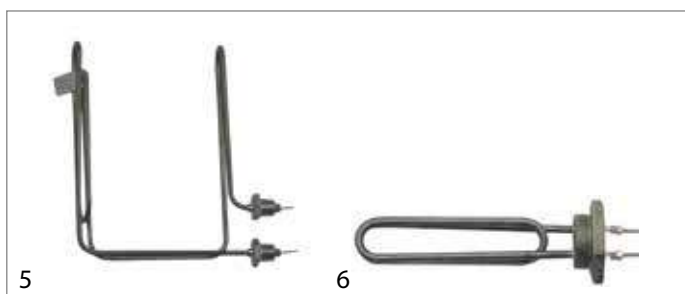

fig.	Vare nr.	P (W)	volt. (V)	HC	L (mm)	W (mm)	Ref. No.
5	415008	2000	230	1	140	173	230016
6	415005	2000	230	1	170	32	230003

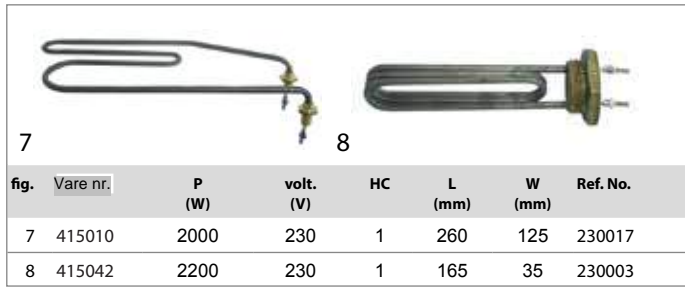

fig.	Vare nr.	P (W)	volt. (V)	HC	L (mm)	W (mm)	Ref. No.
7	415010	2000	230	1	260	125	230017
8	415042	2200	230	1	165	35	230003

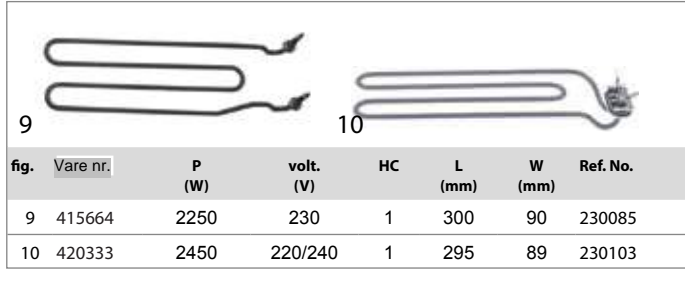

fig.	Vare nr.	P (W)	volt. (V)	HC	L (mm)	W (mm)	Ref. No.
9	415664	2250	230	1	300	90	230085
10	420333	2450	220/240	1	295	89	230103

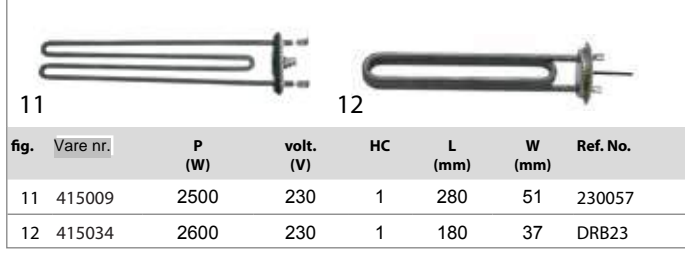

fig.	Vare nr.	P (W)	volt. (V)	HC	L (mm)	W (mm)	Ref. No.
11	415009	2500	230	1	280	51	230057
12	415034	2600	230	1	180	37	DRB23



fig.	Vare nr.	P (W)	volt. (V)	HC	L (mm)	W (mm)	Ref. No.
13	418642	2600	230	1	260	33	230113
14	416239	2600	230	1	270	65	230100



fig.	Vare nr.	P (W)	volt. (V)	HC	L (mm)	W (mm)	Ref. No.
15	415668	2625	230	1	190	41	—
15	415002	3000	230	1	198	35	230012
15	416235	3000	230	1	320	50	80360
16	415000	2900	230	1	272	51	230088

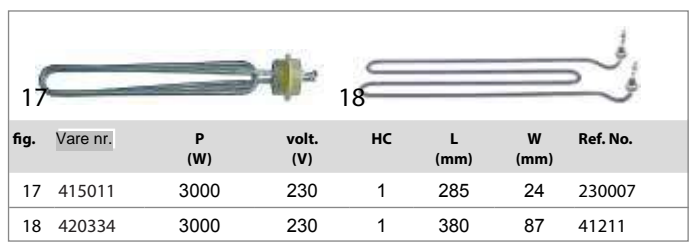

fig.	Vare nr.	P (W)	volt. (V)	HC	L (mm)	W (mm)	Ref. No.
17	415011	3000	230	1	285	24	230007
18	420334	3000	230	1	380	87	41211

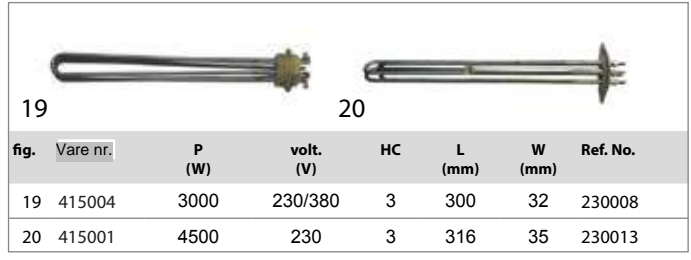

fig.	Vare nr.	P (W)	volt. (V)	HC	L (mm)	W (mm)	Ref. No.
19	415004	3000	230/380	3	300	32	230008
20	415001	4500	230	3	316	35	230013

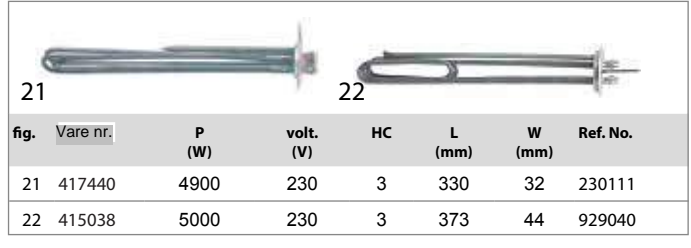

fig.	Vare nr.	P (W)	volt. (V)	HC	L (mm)	W (mm)	Ref. No.
21	417440	4900	230	3	330	32	230111
22	415038	5000	230	3	373	44	929040

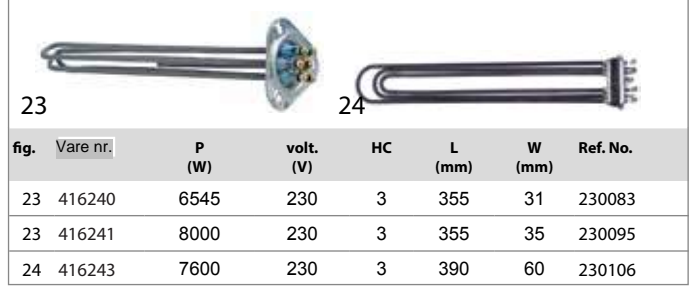

fig.	Vare nr.	P (W)	volt. (V)	HC	L (mm)	W (mm)	Ref. No.
23	416240	6545	230	3	355	31	230083
23	416241	8000	230	3	355	35	230095
24	416243	7600	230	3	390	60	230106

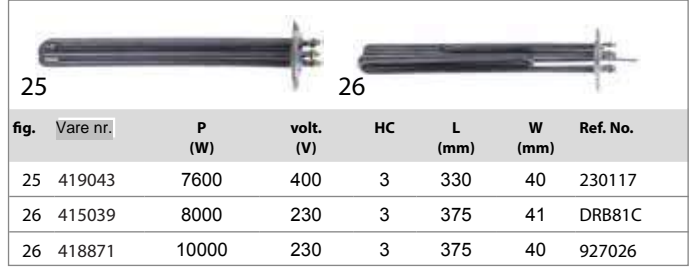

fig.	Vare nr.	P (W)	volt. (V)	HC	L (mm)	W (mm)	Ref. No.
25	419043	7600	400	3	330	40	230117
26	415039	8000	230	3	375	41	DRB81C
26	418871	10000	230	3	375	40	927026

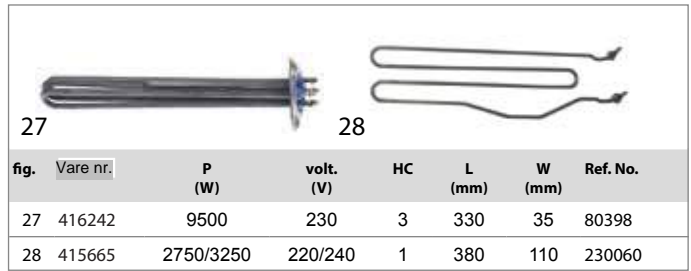

fig.	Vare nr.	P (W)	volt. (V)	HC	L (mm)	W (mm)	Ref. No.
27	416242	9500	230	3	330	35	80398
28	415665	2750/3250	220/240	1	380	110	230060



Elframo



fig.	Vare nr.	P (W)	volt. (V)	HC	L (mm)	W (mm)	Ref. No.
1	418981	1300	230	1	213	67	00003277
2	416281	2000	230	1	300	76	00203091
2	416282	3000	230	1	350	77	00018070



fig.	Vare nr.	P (W)	volt. (V)	HC	L (mm)	W (mm)	Ref. No.
3	415176	2700	230	1	350	70	00203089
4	418574	3000	230	1	233	45	00203052



fig.	Vare nr.	P (W)	volt. (V)	HC	L (mm)	W (mm)	Ref. No.
5	418548	5200	230	3	325	47	00003325
6	415153	5700	230	3	300	85	00003270

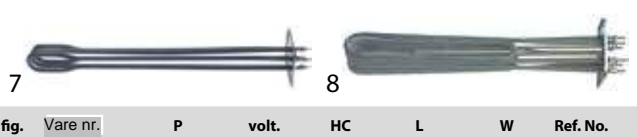

fig.	Vare nr.	P (W)	volt. (V)	HC	L (mm)	W (mm)	Ref. No.
7	420213	9000	240	3	483	46	00003335
8	418879	9800	230	3	322	37	00003349

Elviomex-Alfa



fig.	Vare nr.	P (W)	volt. (V)	HC	L (mm)	W (mm)	Ref. No.
1	416250	2000	230	1	250	25	003.30.00000
2	416254	2400	230	1	295	40	003.35.00009

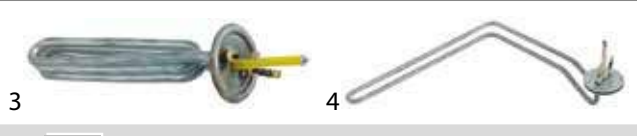

fig.	Vare nr.	P (W)	volt. (V)	HC	L (mm)	W (mm)	Ref. No.
3	416255	2500	230	1	230	34	003.40.00006
4	416251	2500	230	1	290	285	003.40.00011

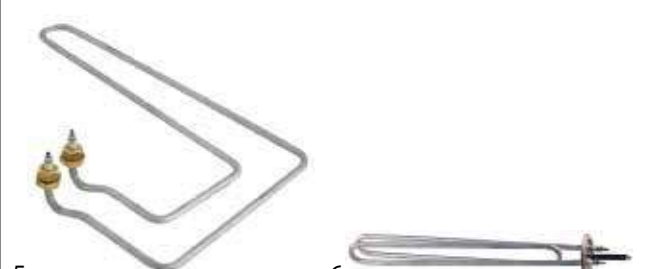

fig.	Vare nr.	P (W)	volt. (V)	HC	L (mm)	W (mm)	Ref. No.
5	416252	2800	230	1	370	240	003.50.00008
6	418216	3000	230	1	370	40	003.50.00005



fig.	Vare nr.	P (W)	volt. (V)	HC	L (mm)	W (mm)	Ref. No.
7	417573	3990	230	3	320	120	003.10.00000
8	416258	4000	230	3	363	33	003.00.00351



fig.	Vare nr.	P (W)	volt. (V)	HC	L (mm)	W (mm)	Ref. No.
9	416253	6000	230	3	360	115	003.15.00095
10	416257	6000	230/400	3	360	37	003.00.00411

Emmepi



fig.	Vare nr.	P (W)	volt. (V)	HC	L (mm)	W (mm)	Ref. No.
1	418548	5200	230	3	325	47	8C0728
2	418084	7599	230	3	340	36	807858



fig.	Vare nr.	P (W)	volt. (V)	HC	L (mm)	W (mm)	Ref. No.
3	416078	8000	230	3	305	39	808595

Fabar

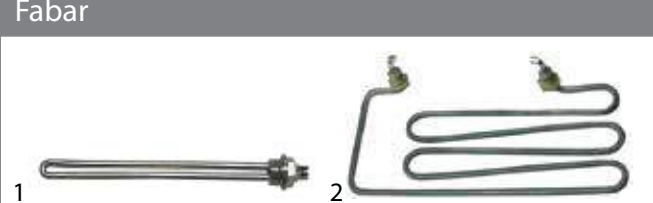

fig.	Vare nr.	P (W)	volt. (V)	HC	L (mm)	W (mm)	Ref. No.
1	415160	1000	230	1	205	21	10163
2	415163	1400	220	1	310	135	18253

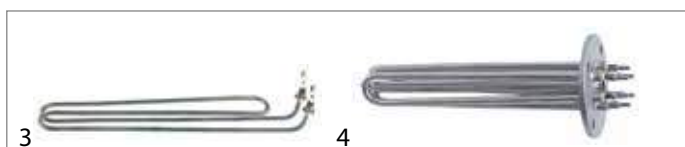

fig.	Vare nr.	P (W)	volt. (V)	HC	L (mm)	W (mm)	Ref. No.
3	416260	2500	230	1	357	34	18253D
4	415161	2700	230/400	3	235	47	10162

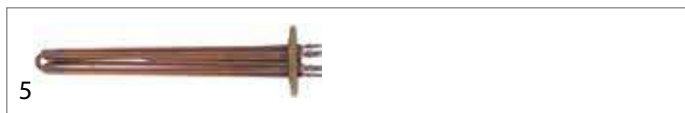

fig.	Vare nr.	P (W)	volt. (V)	HC	L (mm)	W (mm)	Ref. No.
5	420322	8000	230/400	3	400	47	10162C

Fagor

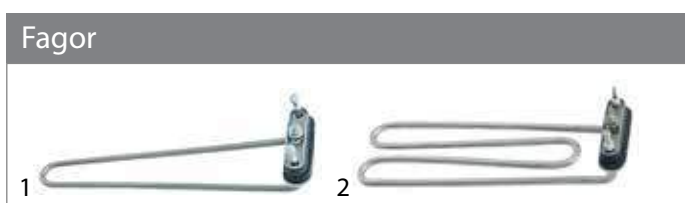

fig.	Vare nr.	P (W)	volt. (V)	HC	L (mm)	W (mm)	Ref. No.
1	416380	1000	230	1	273	63	12024986
2	416381	2000	230	1	280	78	12024951



fig.	Vare nr.	P (W)	volt. (V)	HC	L (mm)	W (mm)	Ref. No.
3	417222	2000	230	1	280	140	12017628
4	416383	2400	230	1	278	39	12024559

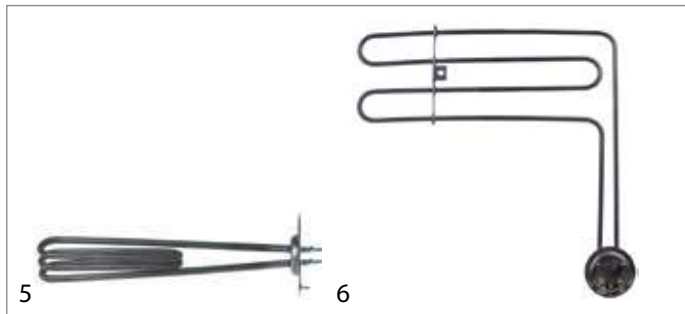

fig.	Vare nr.	P (W)	volt. (V)	HC	L (mm)	W (mm)	Ref. No.
5	416375	2800	230	1	290	37	12024907
6	418797	2800	230	1	365	340	12017800



fig.	Vare nr.	P (W)	volt. (V)	HC	L (mm)	W (mm)	Ref. No.
7	416382	2800	230	1	370	102	12024645
8	416384	2800	230	1	427	44	12024683

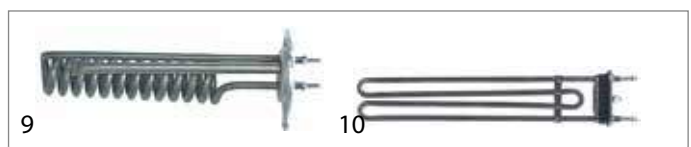

fig.	Vare nr.	P (W)	volt. (V)	HC	L (mm)	W (mm)	Ref. No.
9	416235	3000	230	1	320	50	12030300
10	418832	3000	230	1	350	63	12018752



fig.	Vare nr.	P (W)	volt. (V)	HC	L (mm)	W (mm)	Ref. No.
11	418885	4000	230	1	350	63	12023242
12	417236	4200	230	2	395	70	12017885



fig.	Vare nr.	P (W)	volt. (V)	HC	L (mm)	W (mm)	Ref. No.
13	418529	4500	230	3	365	65	12023778
14	418800	6000	230	1	510	60	12041359



fig.	Vare nr.	P (W)	volt. (V)	HC	L (mm)	W (mm)	Ref. No.
15	415021	6000	230	3	343	37	12024713
16	416385	6000	230	3	420	39	12024732

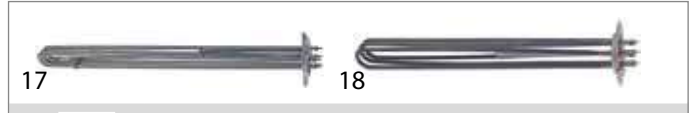

fig.	Vare nr.	P (W)	volt. (V)	HC	L (mm)	W (mm)	Ref. No.
17	420324	6000	230	3	545	36	12024740
17	420325	12000	230	3	545	36	12024721
18	420326	9000	220	3	454	48	12017495

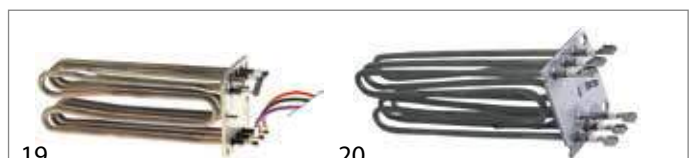

fig.	Vare nr.	P (W)	volt. (V)	HC	L (mm)	W (mm)	Ref. No.
19	418369	9000	230	3	192	39	12029395
20	415550	9000	230	3	205	38	12027948



fig.	Vare nr.	P (W)	volt. (V)	HC	L (mm)	W (mm)	Ref. No.
21	420362	9000	230	3	280	77	12024747
22	417197	9000	230	3	280	78	12024752

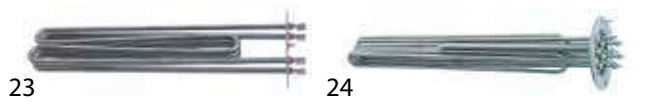



fig.	Vare nr.	P (W)	volt. (V)	HC	L (mm)	W (mm)	Ref. No.
23	416606	9000	230	3	380	75	12023494
24	416614	9600	230	3	425	50	12023926
24	416386	12000	230	3	428	45	12024146



fig.	Vare nr.	P (W)	volt. (V)	HC	L (mm)	W (mm)	Ref. No.
25	418798	9600	230	3	545	36	12024214
26	418370	18000	230	6	194	87	12026917

Falcon



fig.	Vare nr.	P (W)	volt. (V)	HC	L (mm)	W (mm)	Ref. No.
1	415151	2500	230	1	273	130	738010810

Fimar



fig.	Vare nr.	P (W)	volt. (V)	HC	L (mm)	W (mm)	Ref. No.
1	420058	1950	230	1	238	64	CO0135

Firex



fig.	Vare nr.	P (W)	volt. (V)	HC	L (mm)	W (mm)	Ref. No.
1	416834	8000	230	3	323	35	40400040
2	418505	8000	230	3	497	35	40400048



fig.	Vare nr.	P (W)	volt. (V)	HC	L (mm)	W (mm)	Ref. No.
3	419113	9000	230	3	550	38	40400038

Foinox



fig.	Vare nr.	P (W)	volt. (V)	HC	L (mm)	W (mm)	Ref. No.
1	418137	3000	230	1	220	65	10622
2	418136	4360	240	3	310	31	3434

Forcar



fig.	Vare nr.	P (W)	volt. (V)	HC	L (mm)	W (mm)	Ref. No.
1	420058	1950	230	1	238	64	SL0560

GAM

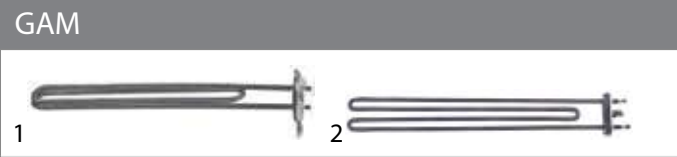

fig.	Vare nr.	P (W)	volt. (V)	HC	L (mm)	W (mm)	Ref. No.
1	420278	3000	240	1	310	34	KR103420
2	420045	3000	240	1	350	45	KR103408

Gico



fig.	Vare nr.	P (W)	volt. (V)	HC	L (mm)	W (mm)	Ref. No.
1	417573	3990	230	3	320	120	434008100
2	416112	4500	230	3	420	25	A00149

GIGA

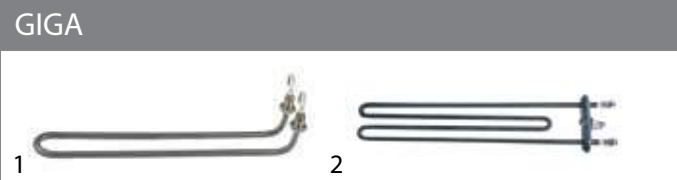

fig.	Vare nr.	P (W)	volt. (V)	HC	L (mm)	W (mm)	Ref. No.
1	416244	1000	230	1	258	34	Y19700
2	415000	2900	230	1	272	51	—

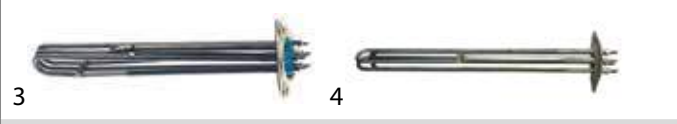

fig.	Vare nr.	P (W)	volt. (V)	HC	L (mm)	W (mm)	Ref. No.
3	418136	4360	240	3	310	31	080328DHE
3	418439	8000	230	3	315	37	E11500
4	415001	4500	230	3	316	35	—



fig.	Vare nr.	P (W)	volt. (V)	HC	L (mm)	W (mm)	Ref. No.
5	415665	2750/3250	220/240	1	380	110	—



Giorik



fig.	Vare nr.	P (W)	volt. (V)	HC	L (mm)	W (mm)	Ref. No.
1	418084	7599	230	3	340	36	6003290
2	418085	10000	230	3	393	38	6003295

Grandimpianti

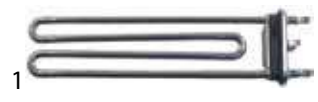

fig.	Vare nr.	P (W)	volt. (V)	HC	L (mm)	W (mm)	Ref. No.
1	419219	3000	230	1	260	65	4PR342000028

Hemerson

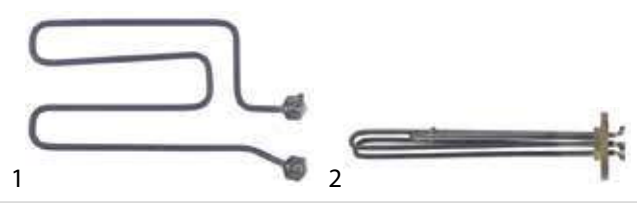

fig.	Vare nr.	P (W)	volt. (V)	HC	L (mm)	W (mm)	Ref. No.
1	418881	2000	230	1	245	120	041007
2	418883	2700	230	2	295	21	041129



fig.	Vare nr.	P (W)	volt. (V)	HC	L (mm)	W (mm)	Ref. No.
3	418882	3990	230	3	300	32	140217
4	415271	4500	230	3	88	285	141101

Henny-Penny



fig.	Vare nr.	P (W)	volt. (V)	HC	L (mm)	W (mm)	Ref. No.
1	418369	9000	230	3	192	39	44.00.194

Hobart



fig.	Vare nr.	P (W)	volt. (V)	HC	L (mm)	W (mm)	Ref. No.
1	416234	600	230	1	160	45	139321-719
2	416293	610	254	1	370	120	231982-9

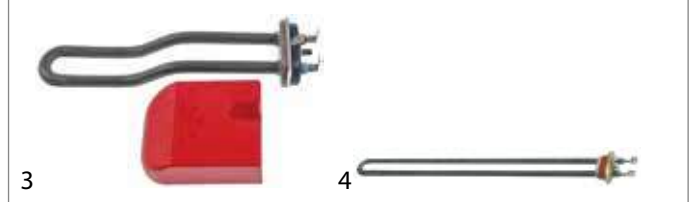

fig.	Vare nr.	P (W)	volt. (V)	HC	L (mm)	W (mm)	Ref. No.
3	420462	975	250	1	168	32	01-515292-1
4	416283	1830	254	1	385	36	324646-1
4	416287	2000	230	1	388	64	324644-2
4	416286	3000	230	1	408	65	324644-1
4	416388	3000	230	1	410	33	324646-4
4	416285	3050	254	1	400	36	324646-3



fig.	Vare nr.	P (W)	volt. (V)	HC	L (mm)	W (mm)	Ref. No.
5	420353	2000	220	1	335	39	227953-1
6	420071	2000	240	1	320	36	01-240766-101



fig.	Vare nr.	P (W)	volt. (V)	HC	L (mm)	W (mm)	Ref. No.
7	416284	2440	254	1	402	34	324646-2
8	415668	2625	230	1	190	41	139221-246



fig.	Vare nr.	P (W)	volt. (V)	HC	L (mm)	W (mm)	Ref. No.
9	416292	2700	230	1	380	105	324187-2
10	419162	3000	240	1	318	65	775464-2



fig.	Vare nr.	P (W)	volt. (V)	HC	L (mm)	W (mm)	Ref. No.
11	417517	3000	254	1	420	70	883423-1
12	416288	4000	230	2	410	63	324637-2
12	416289	6000	230	2	417	65	324637-1
12	419026	6100	254	2	420	63	324637-3



fig.	Vare nr.	P (W)	volt. (V)	HC	L (mm)	W (mm)	Ref. No.
13	415001	4500	230	3	316	35	37145012
14	419139	6000	240	2	315	62	775464-1





fig.	Vare nr.	P (W)	volt. (V)	HC	L (mm)	W (mm)	Ref. No.
15	420302	6000	240	3	325	33	01-240761-1
16	416240	6545	230	3	355	31	139321-1031



fig.	Vare nr.	P (W)	volt. (V)	HC	L (mm)	W (mm)	Ref. No.
17	419005	7260	250	3	375	31	01-240135-2
18	419183	7320	254	3	355	35	323949-1

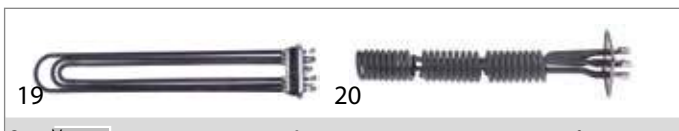

fig.	Vare nr.	P (W)	volt. (V)	HC	L (mm)	W (mm)	Ref. No.
19	416243	7600	230	3	390	60	139321-463
20	416502	8000	240	3	305	40	845370-1



fig.	Vare nr.	P (W)	volt. (V)	HC	L (mm)	W (mm)	Ref. No.
21	416298	9000	230	3	230	120	226506-1
22	416291	9000	230	3	407	42	324206-7

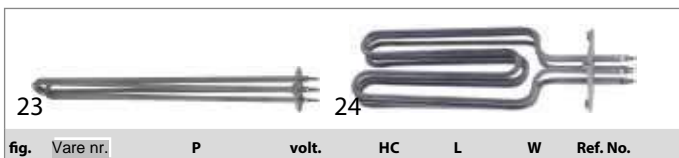

fig.	Vare nr.	P (W)	volt. (V)	HC	L (mm)	W (mm)	Ref. No.
23	419103	9000	240	3	520	47	229148-2
24	420351	10000	220/380	3	360	127	166151-1



fig.	Vare nr.	P (W)	volt. (V)	HC	L (mm)	W (mm)	Ref. No.
25	415665	2750/3250	220/240	1	380	110	E230086

Hoonved

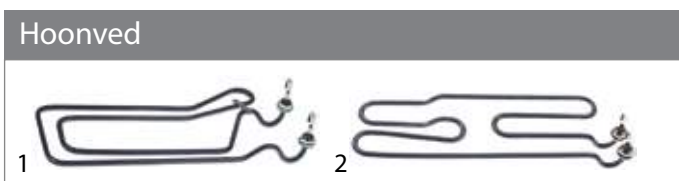

fig.	Vare nr.	P (W)	volt. (V)	HC	L (mm)	W (mm)	Ref. No.
1	416389	2000	230	1	163	290	35230
2	420297	2000	230	1	305	110	110269



fig.	Vare nr.	P (W)	volt. (V)	HC	L (mm)	W (mm)	Ref. No.
3	415198	2000	230	1	318	85	35162
4	415196	2000	230	2	305	34	25370

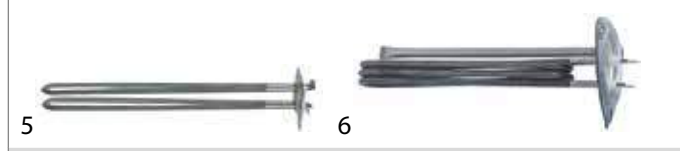

fig.	Vare nr.	P (W)	volt. (V)	HC	L (mm)	W (mm)	Ref. No.
5	415276	2400	230	2	297	34	25353
6	415060	3000	230	1	330	45	H110363

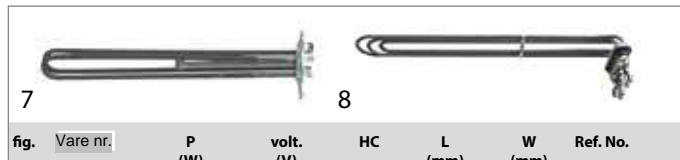

fig.	Vare nr.	P (W)	volt. (V)	HC	L (mm)	W (mm)	Ref. No.
7	415167	3000	230	2	300	21	25356
8	415016	3000	230	3	398	60	33339



fig.	Vare nr.	P (W)	volt. (V)	HC	L (mm)	W (mm)	Ref. No.
9	416273	3200	230	1	237	35	H110397
10	416390	3200	230	2	302	37	35484



fig.	Vare nr.	P (W)	volt. (V)	HC	L (mm)	W (mm)	Ref. No.
11	416274	5000	230	3	248	36	H110398
12	420356	5000	230/400	2	305	33	29655



fig.	Vare nr.	P (W)	volt. (V)	HC	L (mm)	W (mm)	Ref. No.
13	415021	6000	230	3	343	37	33400
14	415670	8000	230	3	480	40	H110343
14	415022	9000	230/400	3	475	36	100362
14	418624	10000	230/400	3	480	35	27298
14	415023	12500	230	3	630	36	H110367
14	420342	14000	230/400	3	620	33	H110386



Hounö



fig.	Vare nr.	P (W)	volt. (V)	HC	L (mm)	W (mm)	Ref. No.
1	419129	1300	230	1	380	60	20720278
2	420371	7500	240-415	3	200	40	30720643

Ilsa



fig.	Vare nr.	P (W)	volt. (V)	HC	L (mm)	W (mm)	Ref. No.
1	416685	2500	230	1	490	-	R210050

Jemi

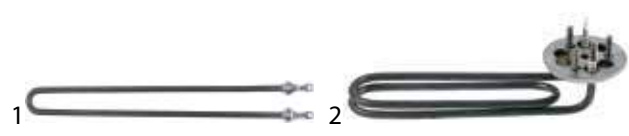

fig.	Vare nr.	P (W)	volt. (V)	HC	L (mm)	W (mm)	Ref. No.
1	420114	500	230	1	365	40	240001
1	420115	750	230	1	533	40	240002
2	418756	2600	240	1	185	43	2001211

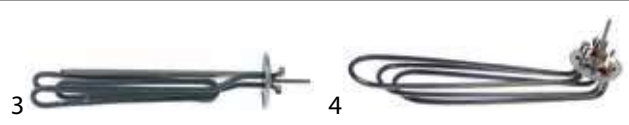

fig.	Vare nr.	P (W)	volt. (V)	HC	L (mm)	W (mm)	Ref. No.
3	418076	2750	240	1	245	33	2001121
4	418840	4800	240	3	295	58	2001232



fig.	Vare nr.	P (W)	volt. (V)	HC	L (mm)	W (mm)	Ref. No.
5	419141	5000	230	3	325	108	2001241
6	415493	6600	240	3	282	35	2001187

Juno



fig.	Vare nr.	P (W)	volt. (V)	HC	L (mm)	W (mm)	Ref. No.
1	415455	450	230	1	242	18.5	0K0604
2	415460	1000	230	1	230	65	0H6199



fig.	Vare nr.	P (W)	volt. (V)	HC	L (mm)	W (mm)	Ref. No.
3	415461	4000	230	2	237	64	0H6170
3	415462	4000	400	2	256	65	0H6202
3	415463	6000	230	2	385	59	0H6171
3	415464	6000	400	2	380	65	0H6198
4	415459	5600	230	2	272	64	0H6146
4	415557	5600	400	2	272	64	0H6164

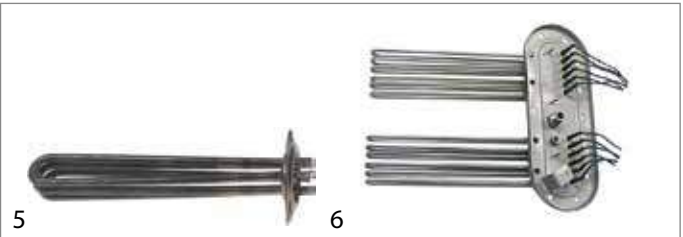

fig.	Vare nr.	P (W)	volt. (V)	HC	L (mm)	W (mm)	Ref. No.
5	415690	9000	230	3	290	32	002835
6	416975	15000	400	6	263	240	0K0516
6	415797	18000	400	6	325	240	0K0517
6	415799	25200	400	6	470	235	0H6153

Komel



fig.	Vare nr.	P (W)	volt. (V)	HC	L (mm)	W (mm)	Ref. No.
1	418981	1300	230	1	213	67	—
2	416281	2000	230	1	300	76	00203091
2	416282	3000	230	1	350	77	00018070



fig.	Vare nr.	P (W)	volt. (V)	HC	L (mm)	W (mm)	Ref. No.
3	415176	2700	230	1	350	70	00203089
4	418574	3000	230	1	233	45	00203052

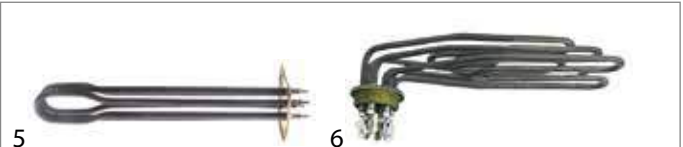

fig.	Vare nr.	P (W)	volt. (V)	HC	L (mm)	W (mm)	Ref. No.
5	418548	5200	230	3	325	47	00003325
6	415153	5700	230	3	300	85	00003270

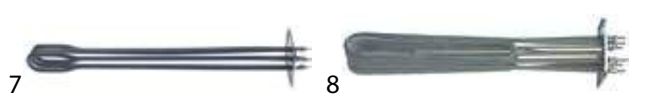



fig.	Vare nr.	P (W)	volt. (V)	HC	L (mm)	W (mm)	Ref. No.
7	420213	9000	240	3	483	46	00003335
8	418879	9800	230	3	322	37	00003349



fig.	Vare nr.	P (W)	volt. (V)	HC	L (mm)	W (mm)	Ref. No.
11	415405	6000	230	3	465	38	49-182416
12	415464	6000	400	2	380	65	—

Kreffft



fig.	Vare nr.	P (W)	volt. (V)	HC	L (mm)	W (mm)	Ref. No.
1	415460	1000	230	1	230	65	—
2	415664	2250	230	1	300	90	62-230085



fig.	Vare nr.	P (W)	volt. (V)	HC	L (mm)	W (mm)	Ref. No.
13	416240	6545	230	3	355	31	62-230083
14	415256	7500	230	3	460	34	43-0101493



fig.	Vare nr.	P (W)	volt. (V)	HC	L (mm)	W (mm)	Ref. No.
3	415009	2500	230	1	280	51	62-230087
4	415668	2625	230	1	190	41	62-230090
4	415002	3000	230	1	198	35	62-230005

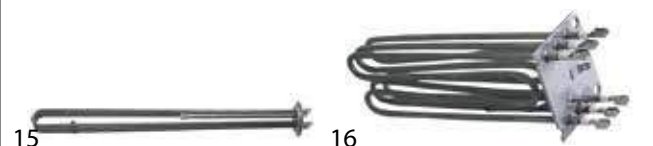

fig.	Vare nr.	P (W)	volt. (V)	HC	L (mm)	W (mm)	Ref. No.
15	415416	7500	230	3	460	37	49-182539
16	415550	9000	230	3	205	38	—
16	415614	9000	230	3	232	76	—

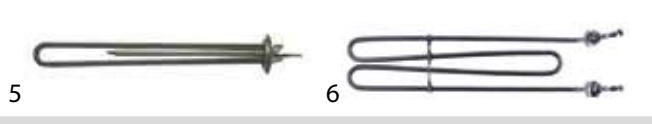

fig.	Vare nr.	P (W)	volt. (V)	HC	L (mm)	W (mm)	Ref. No.
5	415513	2800	230	2	345	35	400222
6	418795	3000	230	1	300	70	602034



fig.	Vare nr.	P (W)	volt. (V)	HC	L (mm)	W (mm)	Ref. No.
17	420159	14000	230/400	3	500	36	63-110392
18	415665	2750/3250	220/240	1	380	110	62-230086

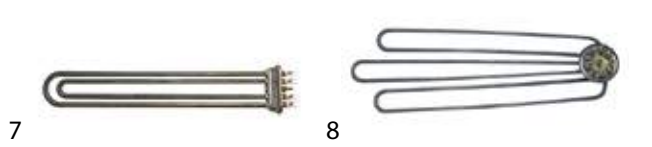

fig.	Vare nr.	P (W)	volt. (V)	HC	L (mm)	W (mm)	Ref. No.
7	415465	3000	230	2	365	65	76-30044306
7	415552	3000	400	2	365	64	76-30044303
7	415466	6000	230	2	365	65	76-30044305
7	415447	6000	230	2	375	65	76-30044155
7	415551	6000	400	2	365	65	76-30044302
7	415448	6000	400	2	370	65	76-30044158
8	415508	3000	230	3	380	125	023235

Kromo

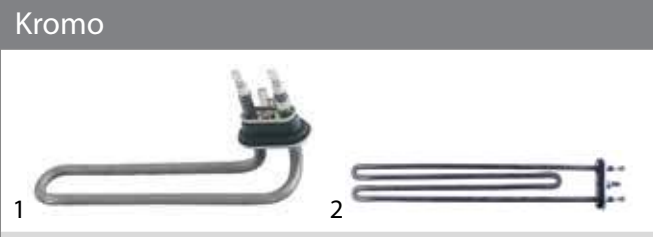

fig.	Vare nr.	P (W)	volt. (V)	HC	L (mm)	W (mm)	Ref. No.
1	416276	1100	230	1	203	40	DW540401
2	415267	1800	230	1	190	41	DW17201
2	415266	2000	230	1	300	41	DW10714



fig.	Vare nr.	P (W)	volt. (V)	HC	L (mm)	W (mm)	Ref. No.
9	415557	5600	400	2	272	64	—
10	415599	6000	230	3	385	31	49-182656



fig.	Vare nr.	P (W)	volt. (V)	HC	L (mm)	W (mm)	Ref. No.
3	415268	1850	230	1	245	40	DW16035/A
3	415270	2700	230	1	335	43	DW150047
4	415261	2400	230	1	242	31	DW18206





fig.	Vare nr.	P (W)	volt. (V)	HC	L (mm)	W (mm)	Ref. No.
5	415260	2500	230	1	185	40	DW16036/A
6	415269	2700	230	3	257	28	DW15047



fig.	Vare nr.	P (W)	volt. (V)	HC	L (mm)	W (mm)	Ref. No.
7	416277	2800	230	1	302	37	DW18206/D
8	420056	2800	230	1	380	34	DW15089/D



fig.	Vare nr.	P (W)	volt. (V)	HC	L (mm)	W (mm)	Ref. No.
9	415262	3000	230	3	260	40	DW15046
10	416398	4000	230	3	287	26	DW18215



fig.	Vare nr.	P (W)	volt. (V)	HC	L (mm)	W (mm)	Ref. No.
11	415271	4500	230	3	88	285	DW10300022
12	415263	4500	230	3	375	38	DW15089



fig.	Vare nr.	P (W)	volt. (V)	HC	L (mm)	W (mm)	Ref. No.
13	420359	6000	230	3	275	32	DW590121
14	416278	6000	230	3	435	38	DW15089/A
14	415264	6000	230	3	480	33	DW30001010
14	416279	12000	230	3	470	48	DW30001011/A
14	420055	14000	230	3	480	36	DW30001011/B



fig.	Vare nr.	P (W)	volt. (V)	HC	L (mm)	W (mm)	Ref. No.
15	415265	9000	230	3	470	35	DW30001011
16	419191	3000-3270	230-240	3	195	35	DW10300011



fig.	Vare nr.	P (W)	volt. (V)	HC	L (mm)	W (mm)	Ref. No.
17	419040	6000/6530	230/240	3	375	38	DW15089/E

Krupps

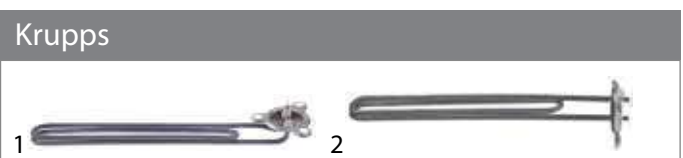

fig.	Vare nr.	P (W)	volt. (V)	HC	L (mm)	W (mm)	Ref. No.
1	420307	2500	230	1	310	35	103450
2	420278	3000	240	1	310	34	103420



fig.	Vare nr.	P (W)	volt. (V)	HC	L (mm)	W (mm)	Ref. No.
3	420045	3000	240	1	350	45	103408
4	420357	4500	220/380	3	440	37	103430

Küppersbusch



fig.	Vare nr.	P (W)	volt. (V)	HC	L (mm)	W (mm)	Ref. No.
1	415507	2000	230	1	250	35	409181
2	415465	3000	230	2	365	65	407264
2	415466	6000	230	2	365	65	407263



fig.	Vare nr.	P (W)	volt. (V)	HC	L (mm)	W (mm)	Ref. No.
3	417530	3000	230	3	255	38	—
4	415604	3000	230/400	3	160	36	182520

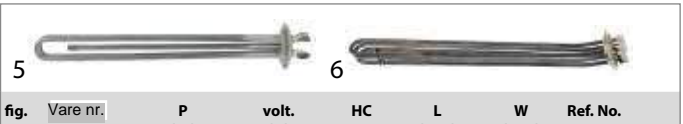

fig.	Vare nr.	P (W)	volt. (V)	HC	L (mm)	W (mm)	Ref. No.
5	415598	4500	230	3	350	28	182655
6	418286	6000	230	2	392	35	540821
6	418270	9000	230	3	535	36	540717

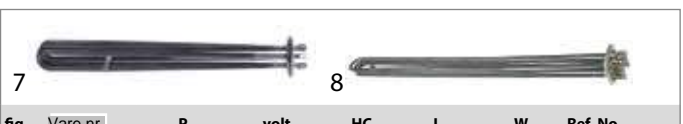

fig.	Vare nr.	P (W)	volt. (V)	HC	L (mm)	W (mm)	Ref. No.
7	415599	6000	230	3	385	31	182656
8	415405	6000	230	3	465	38	182416



fig.	Vare nr.	P (W)	volt. (V)	HC	L (mm)	W (mm)	Ref. No.
9	416945	6000	230	3	470	26	782798004
9	418333	7500	230	3	455	42	160116
10	415416	7500	230	3	460	37	182539



fig.	Vare nr.	P (W)	volt. (V)	HC	L (mm)	W (mm)	Ref. No.
11	415875	9000	230	3	518	34	181736
12	418287	9000	230	3	540	37	540842
12	415888	12000	230	3	510	34	181737

Lainox

fig.	Vare nr.	P (W)	volt. (V)	HC	L (mm)	W (mm)	Ref. No.
1	415021	6000	230	3	343	37	LAR50303250
2	418200	6000	230	3	377	50	LAR65020280

fig.	Vare nr.	P (W)	volt. (V)	HC	L (mm)	W (mm)	Ref. No.
3	415848	7500	230	3	365	36	LAR65020350
4	415849	15000	230	3	530	45	LAR65020420

Lamber

fig.	Vare nr.	P (W)	volt. (V)	HC	L (mm)	W (mm)	Ref. No.
1	420358	1000	230	1	125	40	0303045
2	416227	1000	230	1	195	40	0303044

fig.	Vare nr.	P (W)	volt. (V)	HC	L (mm)	W (mm)	Ref. No.
3	416228	2000	230	1	197	46	0300067
4	416229	2400	230	2	235	37	0303001

fig.	Vare nr.	P (W)	volt. (V)	HC	L (mm)	W (mm)	Ref. No.
5	416230	3000	230	3	235	34	0300011
5	416231	4500	230	3	307	45	0300002
5	416232	6000	230	3	293	40	0300012
5	416233	9000	230	3	440	42	0300299

Lasa

fig.	Vare nr.	P (W)	volt. (V)	HC	L (mm)	W (mm)	Ref. No.
1	415266	2000	230	1	300	41	10714
2	416205	3000	230	1	260	29	—

fig.	Vare nr.	P (W)	volt. (V)	HC	L (mm)	W (mm)	Ref. No.
3	415934	3500	230	3	192	38	3208040
4	418636	4500	230	3	290	28	3208090 senza guarnizione

fig.	Vare nr.	P (W)	volt. (V)	HC	L (mm)	W (mm)	Ref. No.
5	415935	4500	230	3	320	34	3208010
6	415021	6000	230	3	343	37	3208020

fig.	Vare nr.	P (W)	volt. (V)	HC	L (mm)	W (mm)	Ref. No.
7	418686	6000	230	3	350	35	3208080
7	415937	9000	230	3	340	37	—

Lincar

fig.	Vare nr.	P (W)	volt. (V)	HC	L (mm)	W (mm)	Ref. No.
1	419113	9000	230	3	550	38	38000267

LineaBlanca

fig.	Vare nr.	P (W)	volt. (V)	HC	L (mm)	W (mm)	Ref. No.
1	416357	2000	230	1	265	65	A030021
1	416366	2700	230	1	265	65	A030022
1	416367	2700	230	1	280	26	A030019/1
2	418789	2000	230	1	325	85	A030018PLF

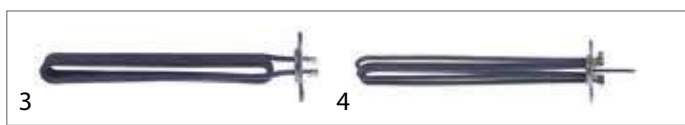

fig.	Vare nr.	P (W)	volt. (V)	HC	L (mm)	W (mm)	Ref. No.
3	418787	3000	230	1	280	25	A030020/1
4	418788	4500	230	3	280	30	A030013

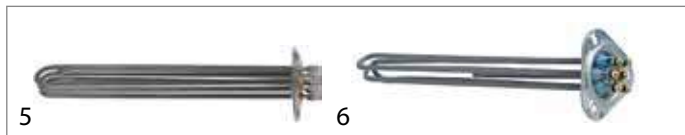

fig.	Vare nr.	P (W)	volt. (V)	HC	L (mm)	W (mm)	Ref. No.
5	419073	6000	230	3	315	33	A030017
6	416241	8000	230	3	355	35	I030007

Lohberger



fig.	Vare nr.	P (W)	volt. (V)	HC	L (mm)	W (mm)	Ref. No.
1	415465	3000	230	2	365	65	F7U47139
2	415794	6000	230	3	360	35	F7U47101

Lotus



fig.	Vare nr.	P (W)	volt. (V)	HC	L (mm)	W (mm)	Ref. No.
1	418040	6000	230	3	385	32	10062
1	418041	8000	230	3	470	42	16600

Luxia



fig.	Vare nr.	P (W)	volt. (V)	HC	L (mm)	W (mm)	Ref. No.
1	416378	1000	230	1	152	35	L7212
2	418709	2400	230	1	190	32	L2128



fig.	Vare nr.	P (W)	volt. (V)	HC	L (mm)	W (mm)	Ref. No.
3	418793	4300	230/400	3	270	30	L2134
3	415028	9000	230/400	3	440	33	L7415

Mach

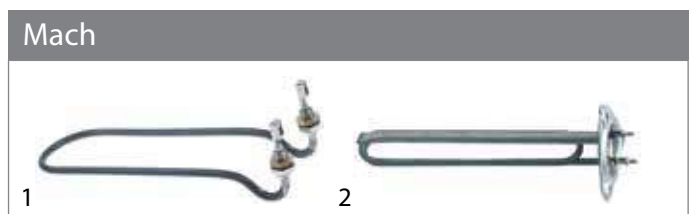

fig.	Vare nr.	P (W)	volt. (V)	HC	L (mm)	W (mm)	Ref. No.
1	419166	1400	230	1	235	50	512054600
1	420364	2500	230	1	270	145	512077900
2	416203	2600	230	1	250	35	512036300



fig.	Vare nr.	P (W)	volt. (V)	HC	L (mm)	W (mm)	Ref. No.
3	416201	2600	230	1	275	85	512049900
4	416205	3000	230	1	260	29	512019800



fig.	Vare nr.	P (W)	volt. (V)	HC	L (mm)	W (mm)	Ref. No.
5	416204	3000	230	3	205	26	512060200
5	416206	4500	230	3	377	27	512004310
5	416207	6000	230	3	400	24	512004410
5	415264	6000	230	3	480	33	80002761

Malag

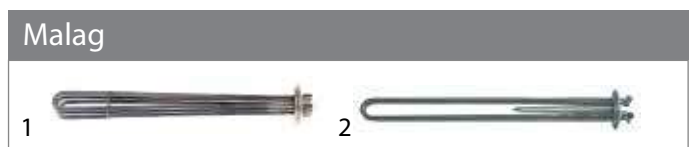

fig.	Vare nr.	P (W)	volt. (V)	HC	L (mm)	W (mm)	Ref. No.
1	415263	4500	230	3	375	38	105724
2	415663	6000	230	3	400	40	105732

Marels



fig.	Vare nr.	P (W)	volt. (V)	HC	L (mm)	W (mm)	Ref. No.
1	420212	2000	230	1	330	33	465.008.14
2	419032	4500	230	3	285	32	465.010.13



fig.	Vare nr.	P (W)	volt. (V)	HC	L (mm)	W (mm)	Ref. No.
3	419033	4500	230	3	295	28	465.009.00



Mareno

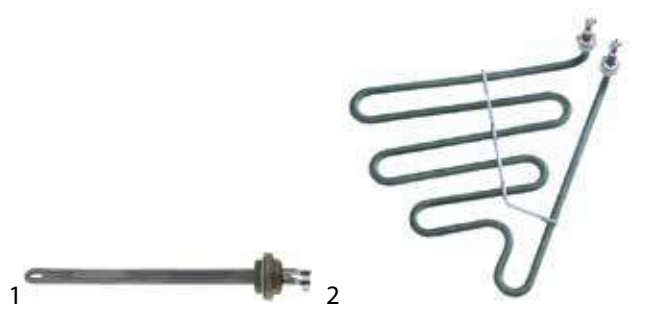

fig.	Vare nr.	P (W)	volt. (V)	HC	L (mm)	W (mm)	Ref. No.
1	420074	260	230	1	242	18	CR0682160
2	416816	2000	230	1	270	242	MA1879000



fig.	Vare nr.	P (W)	volt. (V)	HC	L (mm)	W (mm)	Ref. No.
3	416272	2400	230	1	220	35	110262
4	415060	3000	230	1	330	45	110363



fig.	Vare nr.	P (W)	volt. (V)	HC	L (mm)	W (mm)	Ref. No.
5	415016	3000	230	3	398	60	110227
6	415934	3500	230	3	192	38	1037312600

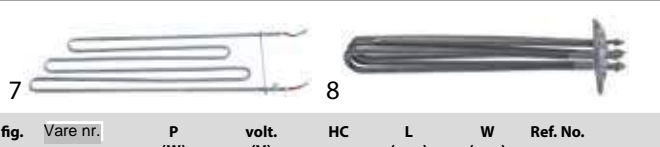

fig.	Vare nr.	P (W)	volt. (V)	HC	L (mm)	W (mm)	Ref. No.
7	416817	4000	230	1	619	150	MACM096301
8	415935	4500	230	3	320	34	1037305400



fig.	Vare nr.	P (W)	volt. (V)	HC	L (mm)	W (mm)	Ref. No.
9	415021	6000	230	3	343	37	110349
10	415984	6000	240-415	3	584	70	MA1878200



fig.	Vare nr.	P (W)	volt. (V)	HC	L (mm)	W (mm)	Ref. No.
11	415937	9000	230	3	340	37	1037312700
12	415957	9000	400	3	402	33	MA5152300

MBM-Italia



fig.	Vare nr.	P (W)	volt. (V)	HC	L (mm)	W (mm)	Ref. No.
1	415001	4500	230	3	316	35	230081
2	417334	4500	230	3	347	36	RTCU700619



fig.	Vare nr.	P (W)	volt. (V)	HC	L (mm)	W (mm)	Ref. No.
3	418141	6000	230	3	297	37	RTFOC00523
3	418140	7500	230	3	295	34	RTFOC00150
4	417332	7200	230	3	485	34	RTCP800008



fig.	Vare nr.	P (W)	volt. (V)	HC	L (mm)	W (mm)	Ref. No.
5	416241	8000	230	3	355	35	230020C
6	416242	9500	230	3	330	35	80398

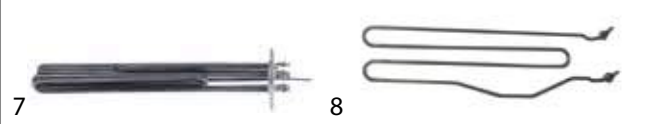

fig.	Vare nr.	P (W)	volt. (V)	HC	L (mm)	W (mm)	Ref. No.
7	418871	10000	230	3	375	40	927276
8	415665	2750/3250	220/240	1	380	110	230060

Meiko

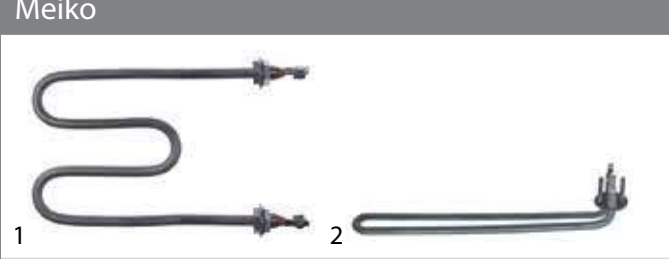

fig.	Vare nr.	P (W)	volt. (V)	HC	L (mm)	W (mm)	Ref. No.
1	418878	2000	230	1	184	131	9546105
2	415507	2000	230	1	250	35	0101152

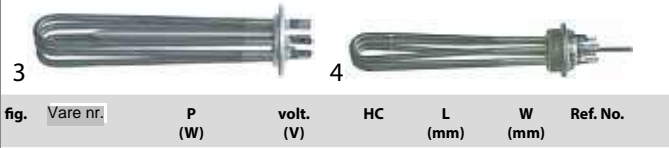

fig.	Vare nr.	P (W)	volt. (V)	HC	L (mm)	W (mm)	Ref. No.
3	415693	3000	230	3	220	30	9504228
4	415506	3000	230	3	230	29	0101140

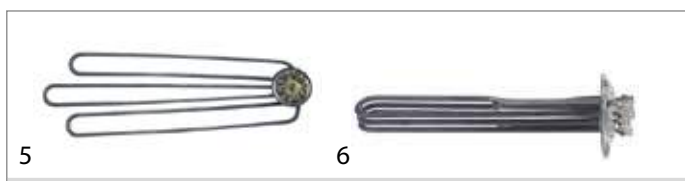

fig.	Vare nr.	P (W)	volt. (V)	HC	L (mm)	W (mm)	Ref. No.
5	415508	3000	230	3	380	125	0101151
6	420158	3600	230	3	270	28	0101195



fig.	Vare nr.	P (W)	volt. (V)	HC	L (mm)	W (mm)	Ref. No.
7	420365	3600	230	3	270	38	0101180
8	417535	4500	230	3	345	33	9504234



fig.	Vare nr.	P (W)	volt. (V)	HC	L (mm)	W (mm)	Ref. No.
9	415502	4500	230	3	370	34	0101142
10	418773	4500	240	3	250	33	9519587



fig.	Vare nr.	P (W)	volt. (V)	HC	L (mm)	W (mm)	Ref. No.
11	415663	6000	230	3	400	40	9504236
11	415873	7500	230	3	415	30	9504237
12	416222	6000	230	3	415	33	9502870



fig.	Vare nr.	P (W)	volt. (V)	HC	L (mm)	W (mm)	Ref. No.
13	418772	7500	240	3	405	32	9519590
14	415510	9000	230	3	420	39	0101149

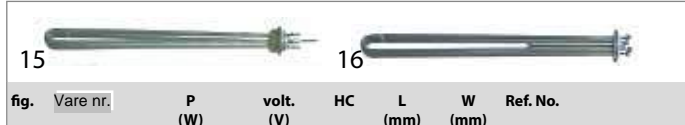

fig.	Vare nr.	P (W)	volt. (V)	HC	L (mm)	W (mm)	Ref. No.
15	415505	9000	230	3	460	33	9502872 old version
16	415692	9000	230	3	485	34	9504240



fig.	Vare nr.	P (W)	volt. (V)	HC	L (mm)	W (mm)	Ref. No.
17	418877	9000	230/400	3	485	30	9519591
18	418769	11000	240	3	502	38	0101186
18	418770	15000	230	3	580	40	0101185

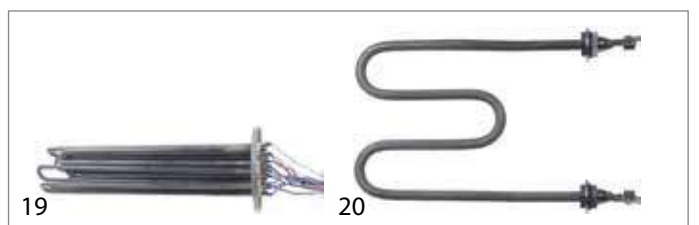

fig.	Vare nr.	P (W)	volt. (V)	HC	L (mm)	W (mm)	Ref. No.
19	419018	36000	415	12	420	90	0101184
20	420072	1000/1500	200/250	1	184	130	9546104



fig.	Vare nr.	P (W)	volt. (V)	HC	L (mm)	W (mm)	Ref. No.
21	419041	6000/6530	230/240	3	330	42	9519588

Metos



fig.	Vare nr.	P (W)	volt. (V)	HC	L (mm)	W (mm)	Ref. No.
1	420444	1800	230	1	205	58	5315388
2	420443	9000	230-400	3	75	72	5315199

MKN



fig.	Vare nr.	P (W)	volt. (V)	HC	L (mm)	W (mm)	Ref. No.
1	415568	800	230	1	220	66	573106
2	415569	5000	230	2	272	65	573108
2	419053	5000	400	2	272	65	573107



fig.	Vare nr.	P (W)	volt. (V)	HC	L (mm)	W (mm)	Ref. No.
3	415402	6000	230	3	425	35	573075

Modular



fig.	Vare nr.	P (W)	volt. (V)	HC	L (mm)	W (mm)	Ref. No.
1	420212	2000	230	1	330	33	465.008.14
2	415014	3000	230	1	240	28	465.011.00

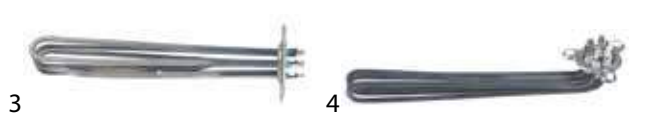



fig.	Vare nr.	P (W)	volt. (V)	HC	L (mm)	W (mm)	Ref. No.
3	419032	4500	230	3	285	32	465.010.13
4	419033	4500	230	3	295	28	465.009.00



fig.	Vare nr.	P (W)	volt. (V)	HC	L (mm)	W (mm)	Ref. No.
5	416662	6000	230	3	405	31	66502200
5	416663	8000	230	3	510	43	96502500

Morice

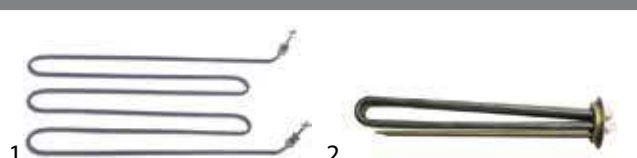

fig.	Vare nr.	P (W)	volt. (V)	HC	L (mm)	W (mm)	Ref. No.
1	420255	2600	230	1	435	225	RS0908
2	415021	6000	230	3	343	37	RS0963

Multi



fig.	Vare nr.	P (W)	volt. (V)	HC	L (mm)	W (mm)	Ref. No.
1	415270	2700	230	1	335	43	130805
2	419032	4500	230	3	285	32	150023



fig.	Vare nr.	P (W)	volt. (V)	HC	L (mm)	W (mm)	Ref. No.
3	415265	9000	230	3	470	35	130011

Nayati



fig.	Vare nr.	P (W)	volt. (V)	HC	L (mm)	W (mm)	Ref. No.
1	415494	4980	230	3	335	30	PD.4119

NuovaSimonelli



fig.	Vare nr.	P (W)	volt. (V)	HC	L (mm)	W (mm)	Ref. No.
1	416219	800	230	1	317	55	18010044.1
1	416216	1800	230	1	330	48	18010044.0
2	416210	2200	230	1	253	25	18011020



fig.	Vare nr.	P (W)	volt. (V)	HC	L (mm)	W (mm)	Ref. No.
3	415195	2500	230	1	200	20	18000004
4	416217	2500	230	1	410	147	18010385



fig.	Vare nr.	P (W)	volt. (V)	HC	L (mm)	W (mm)	Ref. No.
5	416211	2700	230	1	300	25	18010296
6	416212	3000	230	1	330	28.5	18010028.1



fig.	Vare nr.	P (W)	volt. (V)	HC	L (mm)	W (mm)	Ref. No.
7	416218	4500	230	3	275	95	18010716
8	416213	4500	230	3	383	50	18010743
8	416214	6000	230	3	410	32	18010744
8	416215	9000	230	3	410	35	18010745

OEM



fig.	Vare nr.	P (W)	volt. (V)	HC	L (mm)	W (mm)	Ref. No.
1	415195	2500	230	1	200	20	EE001

Offcar



fig.	Vare nr.	P (W)	volt. (V)	HC	L (mm)	W (mm)	Ref. No.
1	416685	2500	230	1	490	-	443685
2	416834	8000	230	3	323	35	FX40400040

Olis



fig.	Vare nr.	P (W)	volt. (V)	HC	L (mm)	W (mm)	Ref. No.
1	415270	2700	230	1	335	43	BN011DWM150047
2	418714	6000	230	3	385	37	BN6A037190
2	416807	7500	230	3	510	40	BN6A037202

3

fig.	Vare nr.	P (W)	volt. (V)	HC	L (mm)	W (mm)	Ref. No.
3	418111	7500	220	6	310	145	BN6A037483
3	418112	15000	220	6	310	230	BN6A037484

Omniwash



1 **2**

fig.	Vare nr.	P (W)	volt. (V)	HC	L (mm)	W (mm)	Ref. No.
1	416219	800	230	1	317	55	CERV8
1	416216	1800	230	1	330	48	CERV18
2	416210	2200	230	1	253	25	CERB22



3 **4**

fig.	Vare nr.	P (W)	volt. (V)	HC	L (mm)	W (mm)	Ref. No.
3	418603	2200	230	1	405	160	CERV22
4	416217	2500	230	1	410	147	CERV25



5 **6**

fig.	Vare nr.	P (W)	volt. (V)	HC	L (mm)	W (mm)	Ref. No.
5	416211	2700	230	1	300	25	CERB2712
6	416212	3000	230	1	330	28.5	CERB30



7 **8**

fig.	Vare nr.	P (W)	volt. (V)	HC	L (mm)	W (mm)	Ref. No.
7	416218	4500	230	3	275	95	CERV453F
8	416213	4500	230	3	383	50	CERB453F
8	416214	6000	230	3	410	32	CERB603F
8	416215	9000	230	3	410	35	CERB903F

Öztiryakiler



1 **2**

fig.	Vare nr.	P (W)	volt. (V)	HC	L (mm)	W (mm)	Ref. No.
1	417529	9000	230	3	440	36	9099.01000.06
2	420366	2000/2500	230	2	418	64	9099.01000.03

Palux

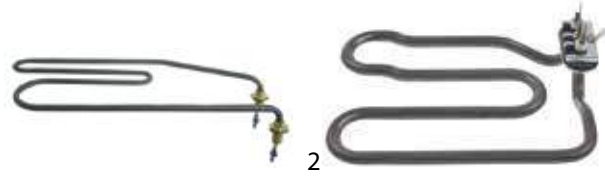

1 **2**

fig.	Vare nr.	P (W)	volt. (V)	HC	L (mm)	W (mm)	Ref. No.
1	415010	2000	230	1	260	125	349577
2	420464	2500	230	1	170	120	73069



3 **4**

fig.	Vare nr.	P (W)	volt. (V)	HC	L (mm)	W (mm)	Ref. No.
3	415195	2500	230	1	200	20	209538
4	415397	2500	230	1	273	85	233978



5 **6**

fig.	Vare nr.	P (W)	volt. (V)	HC	L (mm)	W (mm)	Ref. No.
5	415431	2500	230	1	368	60	350214
5	415432	3000	230	1	370	58	350206
6	415668	2625	230	1	190	41	349801
6	415002	3000	230	1	198	35	386839



7 **8**

fig.	Vare nr.	P (W)	volt. (V)	HC	L (mm)	W (mm)	Ref. No.
7	415604	3000	230/400	3	160	36	702196
8	415429	4000	230	2	370	60	350176



9 **10**

fig.	Vare nr.	P (W)	volt. (V)	HC	L (mm)	W (mm)	Ref. No.
9	415433	6000	230	2	372	58	350192
10	415402	6000	230	3	425	35	103268



11

fig.	Vare nr.	P (W)	volt. (V)	HC	L (mm)	W (mm)	Ref. No.
11	415405	6000	230	3	465	38	826677



Project

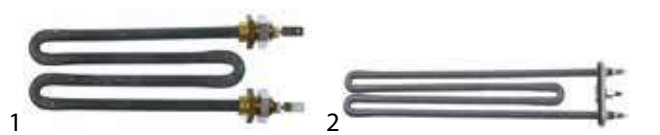

fig.	Vare nr.	P (W)	volt. (V)	HC	L (mm)	W (mm)	Ref. No.
1	418901	1500	230	1	150	55	60645
2	420370	3000	22	1	278	53	60640



fig.	Vare nr.	P (W)	volt. (V)	HC	L (mm)	W (mm)	Ref. No.
3	418899	3000	230	1	265	36	60640N
4	418900	4000	230	3	275	32	30640
4	419001	6000	230/400	3	285	33	50640

Rancilio



fig.	Vare nr.	P (W)	volt. (V)	HC	L (mm)	W (mm)	Ref. No.
1	416234	600	230	1	160	45	65230098
2	416399	2000	230	1	349	35	33122024

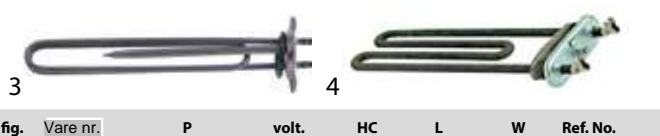

fig.	Vare nr.	P (W)	volt. (V)	HC	L (mm)	W (mm)	Ref. No.
3	418642	2600	230	1	260	33	65230113
4	416239	2600	230	1	270	65	65230100



fig.	Vare nr.	P (W)	volt. (V)	HC	L (mm)	W (mm)	Ref. No.
5	415000	2900	230	1	272	51	65230088
6	416235	3000	230	1	320	50	65080360



fig.	Vare nr.	P (W)	volt. (V)	HC	L (mm)	W (mm)	Ref. No.
7	416398	4000	230	3	287	26	33322004
8	415001	4500	230	3	316	35	65230081



fig.	Vare nr.	P (W)	volt. (V)	HC	L (mm)	W (mm)	Ref. No.
9	417440	4900	230	3	330	32	65230111
10	416240	6545	230	3	355	31	65230083

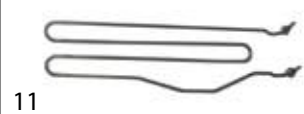

fig.	Vare nr.	P (W)	volt. (V)	HC	L (mm)	W (mm)	Ref. No.
11	415665	2750/3250	220/240	1	380	110	65230086

Rational



fig.	Vare nr.	P (W)	volt. (V)	HC	L (mm)	W (mm)	Ref. No.
1	415465	3000	230	2	365	65	3004.4306
1	415552	3000	400	2	365	64	3004.4142
1	415466	6000	230	2	365	65	3004.4305
1	415447	6000	230	2	375	65	3004.4155
1	415551	6000	400	2	365	65	3004.4302
1	415448	6000	400	2	370	65	3004.4158
2	418369	9000	230	3	192	39	87.00.366



fig.	Vare nr.	P (W)	volt. (V)	HC	L (mm)	W (mm)	Ref. No.
3	415550	9000	230	3	205	38	8720.1590
3	415614	9000	230	3	232	76	3201.1205
4	418370	18000	230	6	194	87	87.00.367

Retigo



fig.	Vare nr.	P (W)	volt. (V)	HC	L (mm)	W (mm)	Ref. No.
1	420360	12000	230	3	330	42	AX24-0008
1	417542	3x3000	230	3	305	68	AX24-0006



Rosinox

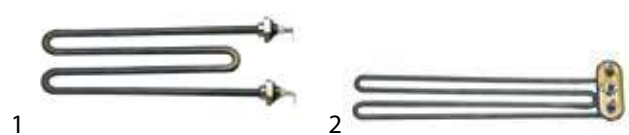

fig.	Vare nr.	P (W)	volt. (V)	HC	L (mm)	W (mm)	Ref. No.
1	415666	1100	230	1	151	56	RX94803566
2	415268	1850	230	1	245	40	RX94808383
2	415270	2700	230	1	335	43	RX94808391



fig.	Vare nr.	P (W)	volt. (V)	HC	L (mm)	W (mm)	Ref. No.
3	415196	2000	230	2	305	34	RX94801438
4	415261	2400	230	1	242	31	RX94808169



fig.	Vare nr.	P (W)	volt. (V)	HC	L (mm)	W (mm)	Ref. No.
5	415269	2700	230	3	257	28	RX94807146
6	415000	2900	230	1	272	51	RX94803855

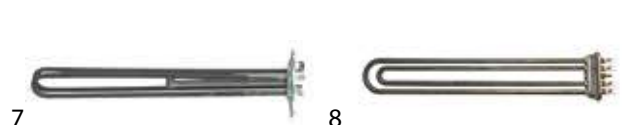

fig.	Vare nr.	P (W)	volt. (V)	HC	L (mm)	W (mm)	Ref. No.
7	415167	3000	230	2	300	21	RX94801222
8	415465	3000	230	2	365	65	RX27318591
8	415466	6000	230	2	365	65	RX27318583



fig.	Vare nr.	P (W)	volt. (V)	HC	L (mm)	W (mm)	Ref. No.
9	415262	3000	230	3	260	40	RX94808375
10	415016	3000	230	3	398	60	RX94813777

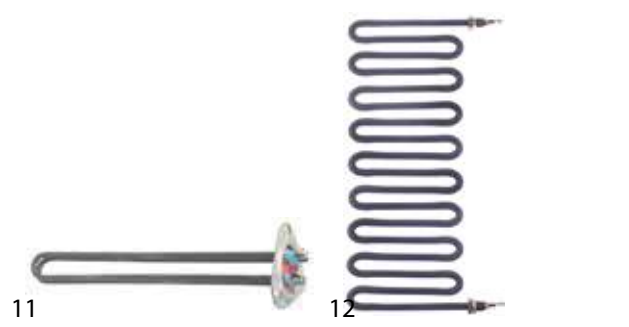

fig.	Vare nr.	P (W)	volt. (V)	HC	L (mm)	W (mm)	Ref. No.
11	416390	3200	230	2	302	37	RX94813775
12	420245	3600	240	1	143	335	RX94050010



fig.	Vare nr.	P (W)	volt. (V)	HC	L (mm)	W (mm)	Ref. No.
13	415278	4000	230	2	290	20	RX94801339
14	415846	4000	230	3	327	36	RX94803574

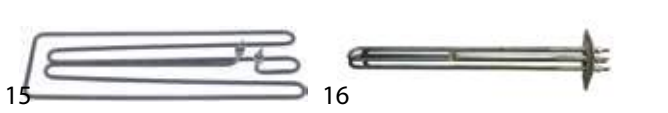

fig.	Vare nr.	P (W)	volt. (V)	HC	L (mm)	W (mm)	Ref. No.
15	420247	4200	240	1	580	165	RX94030558
16	415001	4500	230	3	316	35	RX94803475



fig.	Vare nr.	P (W)	volt. (V)	HC	L (mm)	W (mm)	Ref. No.
17	415263	4500	230	3	375	38	RX94810462
18	420244	4950	230	1	540	33	RX94004629

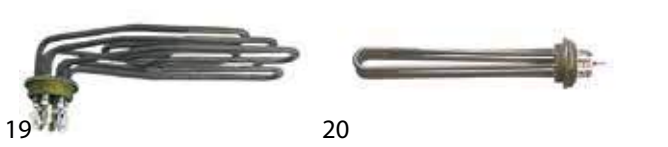

fig.	Vare nr.	P (W)	volt. (V)	HC	L (mm)	W (mm)	Ref. No.
19	415153	5700	230	3	300	85	RX94807138
20	415299	6000	230	3	320	40	RX94806106



fig.	Vare nr.	P (W)	volt. (V)	HC	L (mm)	W (mm)	Ref. No.
21	415021	6000	230	3	343	37	RX94813728
22	415264	6000	230	3	480	33	RX94807286
22	416279	12000	230	3	470	48	RX94808631
22	420055	14000	230	3	480	36	RX94808789



fig.	Vare nr.	P (W)	volt. (V)	HC	L (mm)	W (mm)	Ref. No.
23	415039	8000	230	3	375	41	RX94803442
24	416269	8000	230	3	545	32	RX94800760



fig.	Vare nr.	P (W)	volt. (V)	HC	L (mm)	W (mm)	Ref. No.
25	415265	9000	230	3	470	35	RX94807963
26	415022	9000	230/400	3	475	36	RX94814034
26	418624	10000	230/400	3	480	35	RX94801602

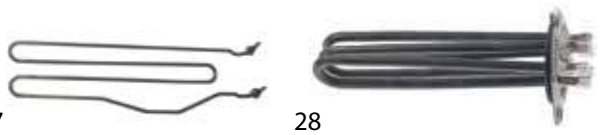



fig.	Vare nr.	P (W)	volt. (V)	HC	L (mm)	W (mm)	Ref. No.
27	415665	2750/3250	220/240	1	380	110	RX94803053
28	419191	3000-3270	230-240	3	195	35	RX94810124

Sammic



fig.	Vare nr.	P (W)	volt. (V)	HC	L (mm)	W (mm)	Ref. No.
1	420028	1500	220	1	115	190	2319207
2	420194	1500	230	1	190	120	2309746



fig.	Vare nr.	P (W)	volt. (V)	HC	L (mm)	W (mm)	Ref. No.
3	420206	2000	230	1	261	33	2313132
4	416357	2000	230	1	265	65	2302830



fig.	Vare nr.	P (W)	volt. (V)	HC	L (mm)	W (mm)	Ref. No.
5	416370	2500	230	1	380	68	2309092
6	420029	2500	230	1	390	95	2313465



fig.	Vare nr.	P (W)	volt. (V)	HC	L (mm)	W (mm)	Ref. No.
7	420207	2800	230	1	297	32	2319070
8	420030	3000	230	1	308	32	2309778



fig.	Vare nr.	P (W)	volt. (V)	HC	L (mm)	W (mm)	Ref. No.
9	420076	3000	230	3	380	65	2309094
10	420031	4500	230	3	365	33	2309100



fig.	Vare nr.	P (W)	volt. (V)	HC	L (mm)	W (mm)	Ref. No.
11	420036	6000	230	3	455	34	2309098
12	420205	9000	230	3	510	34	2309858

Scholl



fig.	Vare nr.	P (W)	volt. (V)	HC	L (mm)	W (mm)	Ref. No.
1	418341	1500	230	1	325	260	71,20,26

Silanos



fig.	Vare nr.	P (W)	volt. (V)	HC	L (mm)	W (mm)	Ref. No.
1	416259	1600	230	1	275	38	905771
2	416209	2000	230	1	180	90	905858



fig.	Vare nr.	P (W)	volt. (V)	HC	L (mm)	W (mm)	Ref. No.
3	417158	2000	230	1	355	36	905575
3	416260	2500	230	1	357	34	905745
3	416261	3000	230	1	358	32	905748
4	416263	2600	230	1	293	26	905493



fig.	Vare nr.	P (W)	volt. (V)	HC	L (mm)	W (mm)	Ref. No.
5	420061	3500	230	3	366	35	905569
6	416267	4500	230	3	358	32	905560
6	416268	6000	230	3	360	34	—
6	416269	8000	230	3	545	32	TR0335



fig.	Vare nr.	P (W)	volt. (V)	HC	L (mm)	W (mm)	Ref. No.
7	416265	6000	400	3	324	43	TR0340
8	418764	9000	230	3	510	37	TR0341



9





fig.	Vare nr.	P (W)	volt. (V)	HC	L (mm)	W (mm)	Ref. No.
9	419138	14000	230	3	515	37	TR0347

Silko

1



2





fig.	Vare nr.	P (W)	volt. (V)	HC	L (mm)	W (mm)	Ref. No.
1	420074	260	230	1	242	18	CR0682160R
2	416817	4000	230	1	619	150	CR0682150

3



4



fig.	Vare nr.	P (W)	volt. (V)	HC	L (mm)	W (mm)	Ref. No.
3	415299	6000	230	3	320	40	SIR0101495
4	415256	7500	230	3	460	34	SIR0101493

Solymac

1





fig.	Vare nr.	P (W)	volt. (V)	HC	L (mm)	W (mm)	Ref. No.
1	420188	3000	230	1	350	300	P47

Star10

1



2



fig.	Vare nr.	P (W)	volt. (V)	HC	L (mm)	W (mm)	Ref. No.
1	416232	6000	230	3	293	40	X60500
2	418439	8000	230	3	315	37	E11500

Tecnoinox

1





fig.	Vare nr.	P (W)	volt. (V)	HC	L (mm)	W (mm)	Ref. No.
1	419113	9000	230	3	550	38	RC40400038

Teikos

1



2





fig.	Vare nr.	P (W)	volt. (V)	HC	L (mm)	W (mm)	Ref. No.
1	419213	2000	230		345	30	843500
2	418682	2500	220	1	360	32	843500 (old)

3



4





fig.	Vare nr.	P (W)	volt. (V)	HC	L (mm)	W (mm)	Ref. No.
3	418217	2500	230	1	240	30	843514
4	415259	4500	230	3	370	31	843511

Therma

1



2





fig.	Vare nr.	P (W)	volt. (V)	HC	L (mm)	W (mm)	Ref. No.
1	415072	2200	230	1	325	83	048086
2	415668	2625	230	1	190	41	0K3789

3



4





fig.	Vare nr.	P (W)	volt. (V)	HC	L (mm)	W (mm)	Ref. No.
3	415066	4500	230	3	310	30	0L1849
4	418782	4500	230	3	330	43	0K4734

5



6



fig.	Vare nr.	P (W)	volt. (V)	HC	L (mm)	W (mm)	Ref. No.
5	418615	7500	230	3	440	35	0L1859
6	418779	9000	230	3	340	52	0L1630

7



fig.	Vare nr.	P (W)	volt. (V)	HC	L (mm)	W (mm)	Ref. No.
7	415063	17000	230	3	590	29	0C5336

Thielmann

1



2



fig.	Vare nr.	P (W)	volt. (V)	HC	L (mm)	W (mm)	Ref. No.
1	415604	3000	230/400	3	160	36	143833
2	418286	6000	230	2	392	35	143834
2	418270	9000	230	3	535	36	143836





fig.	Vare nr.	P (W)	volt. (V)	HC	L (mm)	W (mm)	Ref. No.
3	415405	6000	230	3	465	38	144346
4	418287	9000	230	3	540	37	144347



fig.	Vare nr.	P (W)	volt. (V)	HC	L (mm)	W (mm)	Ref. No.
3	420056	2800	230	1	380	34	WY3DD15089D
4	419040	6000/6530	230/240	3	375	38	WY3DD15089E

Thirode



fig.	Vare nr.	P (W)	volt. (V)	HC	L (mm)	W (mm)	Ref. No.
1	415016	3000	230	3	398	60	—
2	416243	7600	230	3	390	60	2001624H

Whirlpool



fig.	Vare nr.	P (W)	volt. (V)	HC	L (mm)	W (mm)	Ref. No.
1	416259	1600	230	1	275	38	—
2	416260	2500	230	1	357	34	483286001391

Univer-Bar



fig.	Vare nr.	P (W)	volt. (V)	HC	L (mm)	W (mm)	Ref. No.
1	416306	2000	220	1	270	38	2010
2	416307	2000	230	1	270	42	1532



fig.	Vare nr.	P (W)	volt. (V)	HC	L (mm)	W (mm)	Ref. No.
3	416263	2600	230	1	293	26	483286008132
4	420316	6000	230	3	463	40	248249



fig.	Vare nr.	P (W)	volt. (V)	HC	L (mm)	W (mm)	Ref. No.
3	416319	2000	230	1	275	39	4599
4	415266	2000	230	1	300	41	2011



fig.	Vare nr.	P (W)	volt. (V)	HC	L (mm)	W (mm)	Ref. No.
5	418126	7500	220	3	550	37	—
6	418779	9000	230	3	340	52	771985010906

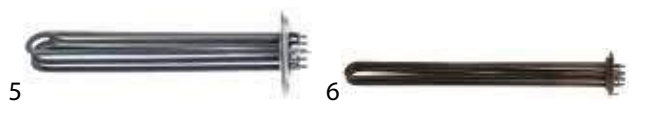

fig.	Vare nr.	P (W)	volt. (V)	HC	L (mm)	W (mm)	Ref. No.
5	416318	3000	230	3	265	32	3010
6	416317	6000	230	3	400	36	4551

Wiesheu-Wiwa



fig.	Vare nr.	P (W)	volt. (V)	HC	L (mm)	W (mm)	Ref. No.
1	415832	7000	230	3	290	32	34950

Voss



fig.	Vare nr.	P (W)	volt. (V)	HC	L (mm)	W (mm)	Ref. No.
1	415794	6000	230	3	360	35	7U47101

Winterhalter



fig.	Vare nr.	P (W)	volt. (V)	HC	L (mm)	W (mm)	Ref. No.
1	416391	2200	230	1	220	24	3103082
2	420402	2600	220-240	1	214	35	60003605

WEGA



fig.	Vare nr.	P (W)	volt. (V)	HC	L (mm)	W (mm)	Ref. No.
1	415268	1850	230	1	245	40	WY3DD16035A
2	416277	2800	230	1	302	37	WY3DD18206D

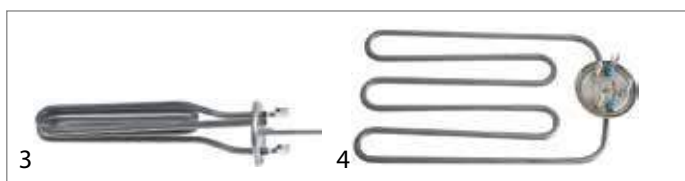

fig.	Vare nr.	P (W)	volt. (V)	HC	L (mm)	W (mm)	Ref. No.
3	420412	2800	230	1	220	28	3103084
3	420395	2800	240	1	220	28	3103033
4	420418	2800	230	1	235	140	3103062

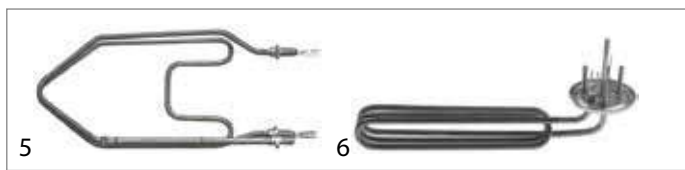

fig.	Vare nr.	P (W)	volt. (V)	HC	L (mm)	W (mm)	Ref. No.
5	415878	2800	230	1	237	120	3103119
6	420408	2800	230	1	245	35	3103047



fig.	Vare nr.	P (W)	volt. (V)	HC	L (mm)	W (mm)	Ref. No.
7	419114	3000	400	3	260	33	30008041
8	419190	3000	400	3	530	30	30008048

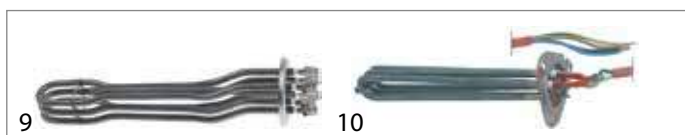

fig.	Vare nr.	P (W)	volt. (V)	HC	L (mm)	W (mm)	Ref. No.
9	420409	3000	230/400	3	220	36	3103027
10	420403	3500	230	3	265	37	60003602



fig.	Vare nr.	P (W)	volt. (V)	HC	L (mm)	W (mm)	Ref. No.
11	415401	4500	230	3	315	33	3103009
12	419189	4900	380-440/200-254	3	266	160	30008074



fig.	Vare nr.	P (W)	volt. (V)	HC	L (mm)	W (mm)	Ref. No.
13	418896	4900	380-440/200-254	3	280	36	30000125
14	420401	4980	230	3	230	165	3103089

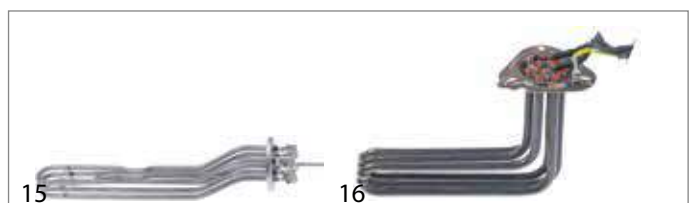

fig.	Vare nr.	P (W)	volt. (V)	HC	L (mm)	W (mm)	Ref. No.
15	420398	4980	230	3	335	30	3103077
15	420410	5000	230	3	290	33	3103030
15	420396	5000	240	3	290	33	3103032
15	420394	6000	230/400	3	282	35	3103017
15	418903	6000	230/400	3	435	30	3103132
15	420400	9000	230	3	430	36	3103018
15	420411	9000	240	3	430	36	3103057
16	420193	5000	400	3	185	32	3103228



fig.	Vare nr.	P (W)	volt. (V)	HC	L (mm)	W (mm)	Ref. No.
17	420404	5000	380-420	3	265	39	60003598
18	420431	6000	230	3	260	60	30008050



fig.	Vare nr.	P (W)	volt. (V)	HC	L (mm)	W (mm)	Ref. No.
19	420397	6000	230	3	335	130	3103025
20	415402	6000	230	3	425	35	3103012



fig.	Vare nr.	P (W)	volt. (V)	HC	L (mm)	W (mm)	Ref. No.
21	416058	6000	400	3	260	32	30008044
22	417532	6000	400	3	520	32	30008051
22	420430	6200	230	3	525	60	30008049

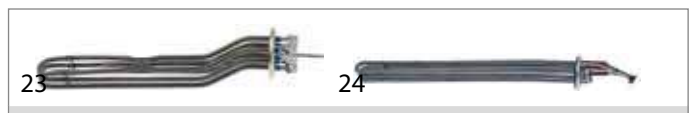

fig.	Vare nr.	P (W)	volt. (V)	HC	L (mm)	W (mm)	Ref. No.
23	420413	6000	240-420	3	282	35	3103043
24	420392	9000	400	3	434	32	30008047



fig.	Vare nr.	P (W)	volt. (V)	HC	L (mm)	W (mm)	Ref. No.
25	420173	9000	400	3	525	33	30008054



Zanussi



fig.	Vare nr.	P (W)	volt. (V)	HC	L (mm)	W (mm)	Ref. No.
1	415272	800	230	1	160	34	049059
2	415010	2000	230	1	260	125	069671



fig.	Vare nr.	P (W)	volt. (V)	HC	L (mm)	W (mm)	Ref. No.
3	418648	2000	230	1	325	65	049755
4	416133	2000	230	1	365	80	0L2109

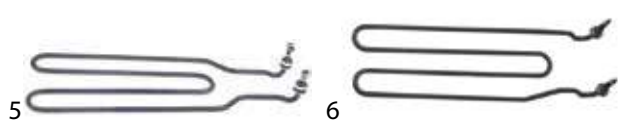

fig.	Vare nr.	P (W)	volt. (V)	HC	L (mm)	W (mm)	Ref. No.
5	415073	2200	220	1	403	138	047507
6	415072	2200	230	1	325	83	048086



fig.	Vare nr.	P (W)	volt. (V)	HC	L (mm)	W (mm)	Ref. No.
7	415070	2200	230	1	355	75	048924
8	415668	2625	230	1	190	41	0K3789
8	415002	3000	230	1	198	35	069455
8	418825	3000	230	1	310	68	049756



fig.	Vare nr.	P (W)	volt. (V)	HC	L (mm)	W (mm)	Ref. No.
9	416130	2800	230	1	310	8.5	049371
9	416135	2800	230	1	375	8.5	049980
10	416132	3000	230	1	360	70	0L1870



fig.	Vare nr.	P (W)	volt. (V)	HC	L (mm)	W (mm)	Ref. No.
11	415174	3000	230	3	160	33	0L1634
12	415067	4500	230	3	218	34	048928



fig.	Vare nr.	P (W)	volt. (V)	HC	L (mm)	W (mm)	Ref. No.
13	416128	4500	230	3	265	30	049955
13	416129	6000	230	3	330	36	0L2108
14	415066	4500	230	3	310	30	0L1849
14	415080	6000	220	3	310	35	0L1878



fig.	Vare nr.	P (W)	volt. (V)	HC	L (mm)	W (mm)	Ref. No.
15	418189	4700	230	3	393	40	002524
16	420141	5000	230	1	116	79	0K8600



fig.	Vare nr.	P (W)	volt. (V)	HC	L (mm)	W (mm)	Ref. No.
17	415459	5600	230	2	272	64	0H6146
18	415068	6000	230	3	370	32	048513



fig.	Vare nr.	P (W)	volt. (V)	HC	L (mm)	W (mm)	Ref. No.
19	420316	6000	230	3	463	40	0K8249
20	415405	6000	230	3	465	38	0L1879



fig.	Vare nr.	P (W)	volt. (V)	HC	L (mm)	W (mm)	Ref. No.
21	415379	6000	230	3	479	36	0L1877
22	415464	6000	400	2	380	65	0H6198

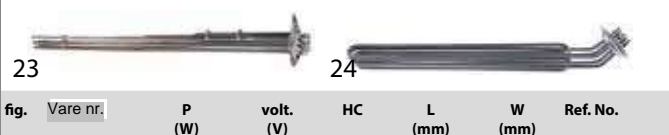

fig.	Vare nr.	P (W)	volt. (V)	HC	L (mm)	W (mm)	Ref. No.
23	418126	7500	220	3	550	37	059665
24	418615	7500	230	3	440	35	0L1859
24	420306	9000	230	3	450	34	0E5163
24	419132	12000	230	3	460	35	0E5162
24	420317	15000	230	3	480	32	0K8505



fig.	Vare nr.	P (W)	volt. (V)	HC	L (mm)	W (mm)	Ref. No.
25	415394	7900	230	3	287	33	058666
26	420312	8000	230	3	455	40	0E5113
26	420313	10000	230	3	455	44	0E7066



fig.	Vare nr.	P (W)	volt. (V)	HC	L (mm)	W (mm)	Ref. No.
27	415690	9000	230	3	290	32	002835
28	418779	9000	230	3	340	52	0L1630



fig.	Vare nr.	P (W)	volt. (V)	HC	L (mm)	W (mm)	Ref. No.
29	416134	10500	230	3	335	52	0L1772
30	418683	10500	230	3	390	35	0L1852



fig.	Vare nr.	P (W)	volt. (V)	HC	L (mm)	W (mm)	Ref. No.
31	418017	10750	230	3	542	35	0C0715
32	415063	17000	230	3	590	29	0C5336



fig.	Vare nr.	P (W)	volt. (V)	HC	L (mm)	W (mm)	Ref. No.
33	418154	17000	400	6	450	39	0C5384
33	418155	24000	400	6	570	40	0C5383
34	415797	18000	400	6	325	240	0K0517
34	415799	25200	400	6	470	235	0H6153



fig.	Vare nr.	P (W)	volt. (V)	HC	L (mm)	W (mm)	Ref. No.
35	415652	24000	400	6	585	32	0C5337

heating elements for convection

ACP



fig.	Vare nr.	P (W)	volt. (V)	HC	L (mm)	W (mm)	Ref. No.
1	419198	2200	230	2	260	245	12000107
1	419192	2700	208	2	260	245	59004076

Ambach



fig.	Vare nr.	P (W)	volt. (V)	L (mm)	ID ø (mm)	ED ø (mm)	Ref. No.
1	416976	1800	230	220	167	182	5060809912
2	415829	7500	230	287	248	260	R65011540
2	415828	15000	230	428	388	408	R65011310
2	418197	15000	230	545	512	530	R65011250

Ambassade

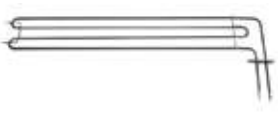

fig.	Vare nr.	P (W)	volt. (V)	L (mm)	ID ø (mm)	ED ø (mm)	Ref. No.
1	415119	1600	230	254	179	197	6539168
1	418936	1700	240	248	176	190	6539168
2	418935	2650	240	252	201	218	6527752

Angelo-Po



fig.	Vare nr.	P (W)	volt. (V)	L (mm)	ID ø (mm)	ED ø (mm)	Ref. No.
1	418100	4150	230	248	214	226	32G1940
2	418101	8700	230	375	317	333	32G1691

1

fig.	Vare nr.	P (W)	volt. (V)	HC	L (mm)	W (mm)	Ref. No.
1	415737	2500	230	1	655	120	32G1280
1	415736	3500	230	1	655	125	32G1360

Ascobloc



1 2

fig.	Vare nr.	P (W)	volt. (V)	L (mm)	ID ø (mm)	ED ø (mm)	Ref. No.
1	415841	3000	230	220	192	205	09/3388
2	415845	3150	230	272	201	215	99/186

Bake-Off



1

fig.	Vare nr.	P (W)	volt. (V)	L (mm)	ID ø (mm)	ED ø (mm)	Ref. No.
1	420189	3100	230	269	220	232	373500041

Bartscher



1 2

fig.	Vare nr.	P (W)	volt. (V)	L (mm)	ID ø (mm)	ED ø (mm)	Ref. No.
1	420038	1260	230	240	181	193	A0YXD1A4A16
1	416850	1260	230	252	182	194	030008381
1	416851	1600	230	250	183	195	A030008458
1	418935	2650	240	252	201	218	06527752
2	418936	1700	240	248	176	190	06539168
2	416852	2500	220	240	183	195	030008461

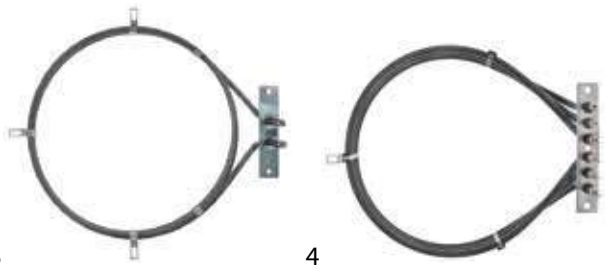

3 4

fig.	Vare nr.	P (W)	volt. (V)	L (mm)	ID ø (mm)	ED ø (mm)	Ref. No.
3	419004	3100	230	260	223	239	010578052
4	417606	4500	230	280	220	240	0RES026



5

fig.	Vare nr.	P (W)	volt. (V)	L (mm)	ID ø (mm)	ED ø (mm)	Ref. No.
5	417607	2x2000	230	240	185	200	0RES000

Bertos



1 2

fig.	Vare nr.	P (W)	volt. (V)	L (mm)	ID ø (mm)	ED ø (mm)	Ref. No.
1	418135	920	230	255	200	215	23016600
2	418133	2000	220	215	187	200	23019200
2	418134	3300	240	215	185	200	23020500



3 4

fig.	Vare nr.	P (W)	volt. (V)	L (mm)	ID ø (mm)	ED ø (mm)	Ref. No.
3	416040	2500	230	212	185	198	22015500
4	418131	6000	230	271	217	231	23021300

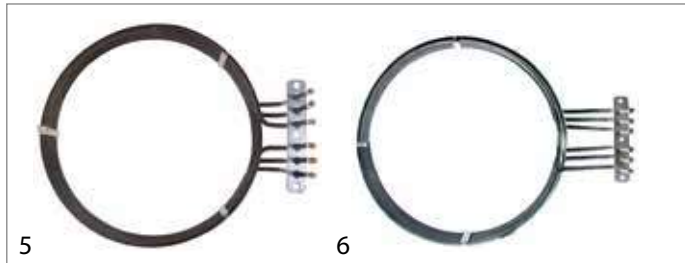

fig.	Vare nr.	P (W)	volt. (V)	L (mm)	ID ø (mm)	ED ø (mm)	Ref. No.
5	418132	7350	230	277	250	265	25021400
6	418129	16000	230	450	337	358	10638



fig.	Vare nr.	P (W)	volt. (V)	HC	L (mm)	W (mm)	Ref. No.
1	418139	3500	240	1	620	120	25040600

Blanco



fig.	Vare nr.	P (W)	volt. (V)	L (mm)	ID ø (mm)	ED ø (mm)	Ref. No.
1	415893	1800	230	216	190	204	105708

Bonnet



fig.	Vare nr.	P (W)	volt. (V)	L (mm)	ID ø (mm)	ED ø (mm)	Ref. No.
1	415134	2500	230	245	180	193	302241
2	418916	9000	240	410	390	410	72104E



fig.	Vare nr.	P (W)	volt. (V)	HC	L (mm)	W (mm)	Ref. No.
1	418925	1500	230	1	293	106	71844E
2	418917	3000	240	3	570	140	309252
2	418918	4000	240	3	570	140	71242E

fig.	Vare nr.	P (W)	volt. (V)	HC	L (mm)	W (mm)	Ref. No.
3	418931	4000	230	1	1130	80	71243E

Bourgeois

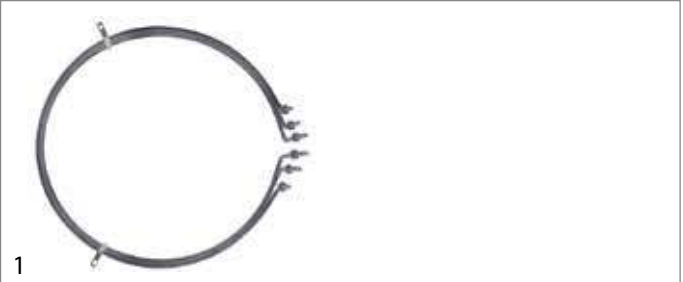

fig.	Vare nr.	P (W)	volt. (V)	L (mm)	ID ø (mm)	ED ø (mm)	Ref. No.
1	418929	6000	240	415	395	415	RC023
1	418930	6000	240	470	430	450	RC022
1	418926	8000	240	328	301	317	RC019
1	418916	9000	240	410	390	410	RC018
1	418928	9000	240	475	458	475	RC017
1	418927	12000	240	472	440	458	RC081

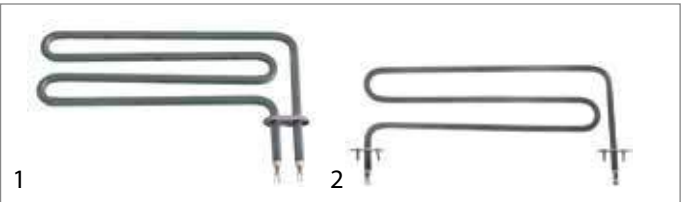

fig.	Vare nr.	P (W)	volt. (V)	HC	L (mm)	W (mm)	Ref. No.
1	418925	1500	230	1	293	106	RC611
1	416500	2000	230	1	295	110	RC601
2	418933	2000	240	1	390	134	RC154

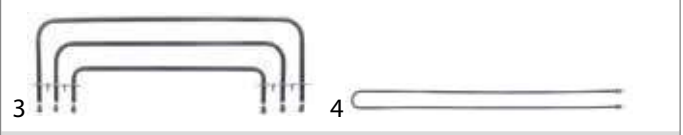

fig.	Vare nr.	P (W)	volt. (V)	HC	L (mm)	W (mm)	Ref. No.
3	418917	3000	240	3	570	140	RC151
3	418918	4000	240	3	570	140	RC511
4	418931	4000	230	1	1130	80	RC126

Capic



fig.	Vare nr.	P (W)	volt. (V)	L (mm)	ID ø (mm)	ED ø (mm)	Ref. No.
1	418848	1500	230	335			E150848 E150850
2	418956	2700	230	410			E151131





fig.	Vare nr.	P (W)	volt. (V)	HC	L (mm)	W (mm)	Ref. No.
1	418955	1500	230	1	393	70	E150824

CB



fig.	Vare nr.	P (W)	volt. (V)	HC	L (mm)	W (mm)	Ref. No.
1	418408	1500	230	1	527	42	07030017
1	418409	2480	230	1	690	43	07030564

Cometto



fig.	Vare nr.	P (W)	volt. (V)	L (mm)	ID ø (mm)	ED ø (mm)	Ref. No.
1	415829	7500	230	287	248	260	A34300700

Convotherm





fig.	Vare nr.	P (W)	volt. (V)	L (mm)	ID ø (mm)	ED ø (mm)	Ref. No.
1	420156	6800	230	300	250	265	2625181
2	415384	9000	230	440	390	403	5007033K
2	415385	15000	220	435	390	405	5007036K





fig.	Vare nr.	P (W)	volt. (V)	L (mm)	ID ø (mm)	ED ø (mm)	Ref. No.
3	418876	18900	230	540	470	486	2619190
3	418768	18900	230	545	467	484	2619181
4	419102	33000	230/400	590	480	570	2619177

Cookmax





fig.	Vare nr.	P (W)	volt. (V)	L (mm)	ID ø (mm)	ED ø (mm)	Ref. No.
1	418745	2900	230	268	220	235	KRS016
1	418746	2900	230	268	220	235	KRS1130A
2	418662	3000	230	217	186	200	401033000





fig.	Vare nr.	P (W)	volt. (V)	L (mm)	ID ø (mm)	ED ø (mm)	Ref. No.
3	415871	6000	230	267	217	230	R65011520
4	415829	7500	230	287	248	260	R65011540
4	415828	15000	230	428	388	408	R65011310

Coreco



fig.	Vare nr.	P (W)	volt. (V)	L (mm)	ID ø (mm)	ED ø (mm)	Ref. No.
1	418301	480	230	160	152	164	—

Coven



fig.	Vare nr.	P (W)	volt. (V)	L (mm)	ID ø (mm)	ED ø (mm)	Ref. No.
1	418986	3000	240	210	180	186	EMRSB030
1	418972	3300	240	205	178	190	EMRSB033



Dexion



fig.	Vare nr.	P (W)	volt. (V)	L (mm)	ID ø (mm)	ED ø (mm)	Ref. No.
1	418345	1600	230	250	178	191	3710004
2	419014	2700	230	247	179	192	011482-00-R

EGO



fig.	Vare nr.	P (W)	volt. (V)	L (mm)	ID ø (mm)	ED ø (mm)	Ref. No.
1	415893	1800	230	216	190	204	20.28907.000
1	415136	2300	230	232	188	202	20.19121.000
1	415120	2450	230	225	192	204	20.19579.050
1	415116	2600	230	220	190	210	20.20219.050
2	416976	1800	230	220	167	182	24.10075.010



fig.	Vare nr.	P (W)	volt. (V)	L (mm)	ID ø (mm)	ED ø (mm)	Ref. No.
3	418468	2000	230	215	192	203	20.21834.010
4	416988	2400	230	255	186	192	20.29477.000



fig.	Vare nr.	P (W)	volt. (V)	L (mm)	ID ø (mm)	ED ø (mm)	Ref. No.
5	415139	2400	230	257	184	199	20.23077.000
5	415138	2500	230	250	179	192	20.21693.000
5	415135	2500	230	255	183	195	20.17983.000
6	415132	2500	230	234	180	192	24.33190.010
6	415134	2500	230	245	180	193	20.17368.010
6	415126	3200	230	244	180	195	20.19279.020

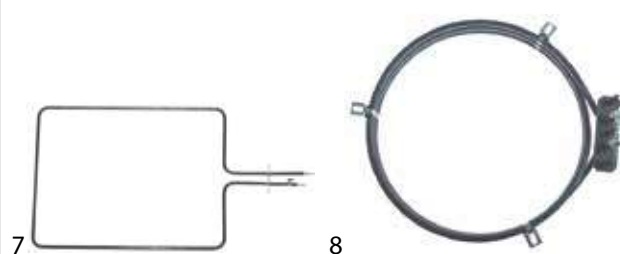

fig.	Vare nr.	P (W)	volt. (V)	L (mm)	ID ø (mm)	ED ø (mm)	Ref. No.
7	415351	2500	230	544	-	-	24.10007.700
8	415841	3000	230	220	192	205	20.20246.000



fig.	Vare nr.	P (W)	volt. (V)	L (mm)	ID ø (mm)	ED ø (mm)	Ref. No.
9	418083	3000	230	245	179	190	20.30404.000 24.10053.880
10	415603	4000	400	240	176	210	20.21874.010
10	415601	6000	400	240	175	210	20.19696.020

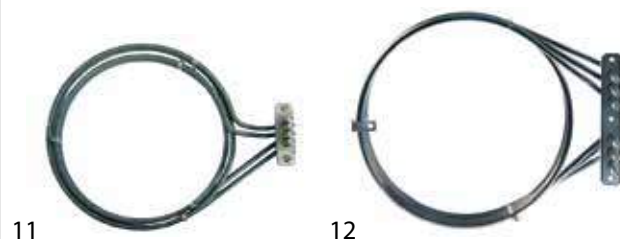

fig.	Vare nr.	P (W)	volt. (V)	L (mm)	ID ø (mm)	ED ø (mm)	Ref. No.
11	415602	4800	400	265	183	213	20.26863.010
12	418131	6000	230	271	217	231	24.30055.310

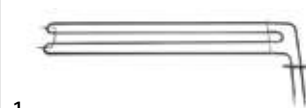

fig.	Vare nr.	P (W)	volt. (V)	HC	L (mm)	W (mm)	Ref. No.
1	415737	2500	230	1	655	120	24.10022.710
1	415736	3500	230	1	655	125	24.10022.730

EKU



fig.	Vare nr.	P (W)	volt. (V)	L (mm)	ID ø (mm)	ED ø (mm)	Ref. No.
1	417586	3200	230	260	178	192	3-55



Electrolux

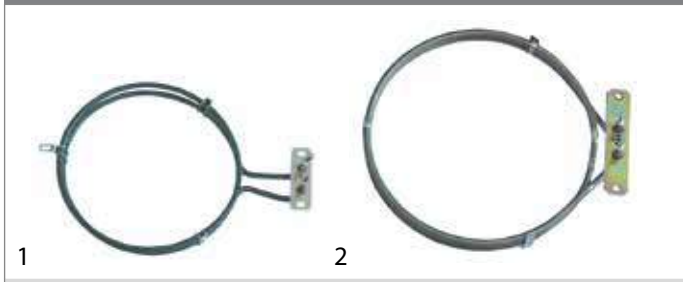

fig.	Vare nr.	P (W)	volt. (V)	L (mm)	ID ø (mm)	ED ø (mm)	Ref. No.
1	415119	1600	230	254	179	197	0A2017
2	415123	1750	220	222	186	199	0H6212
2	418468	2000	230	215	192	203	0H6210
2	415118	2400	230	221	178	190	031485
2	415966	2500	230	210	176	188	004934

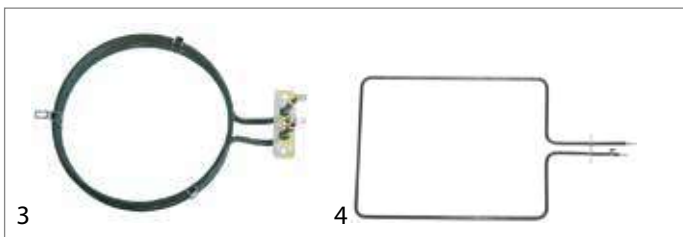

fig.	Vare nr.	P (W)	volt. (V)	L (mm)	ID ø (mm)	ED ø (mm)	Ref. No.
3	415117	2500	230	245	175	195	054843
4	415351	2500	230	544	-	-	056945



fig.	Vare nr.	P (W)	volt. (V)	L (mm)	ID ø (mm)	ED ø (mm)	Ref. No.
5	415116	2600	230	220	190	210	0H6157
6	418083	3000	230	245	179	190	055503

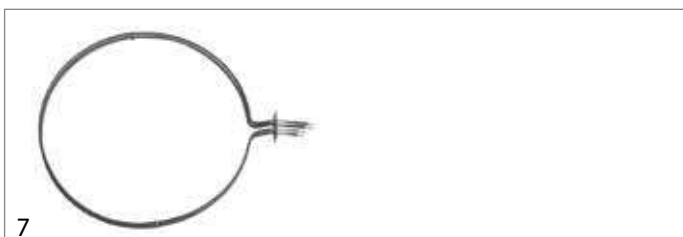

fig.	Vare nr.	P (W)	volt. (V)	L (mm)	ID ø (mm)	ED ø (mm)	Ref. No.
7	415654	5666	230	580	465	480	002688
7	415389	5666	230	590	470	487	058197
7	418151	5670	400	585	467	483	0C5364
7	415656	8000	400	630	560	580	0A5330
7	418152	8000	400	700	569	580	0C5365

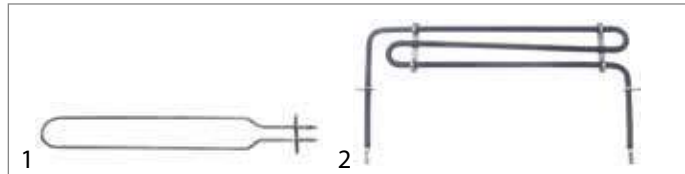

fig.	Vare nr.	P (W)	volt. (V)	HC	L (mm)	W (mm)	Ref. No.
1	415487	1000	230	1	445	65	0K0601
2	420468	1375	230	1	370	87	0E5126

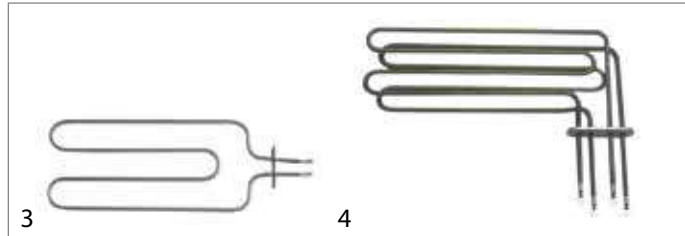

fig.	Vare nr.	P (W)	volt. (V)	HC	L (mm)	W (mm)	Ref. No.
3	415485	2000	230	1	360	155	0H6197
4	415457	3000	230	2	330	135	0H6166
4	415523	3000	400	2	330	135	0H6167

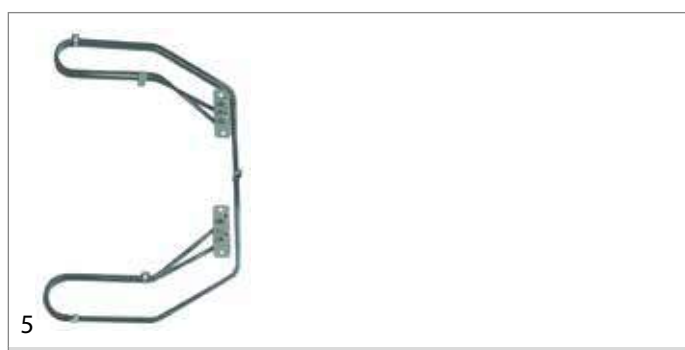

fig.	Vare nr.	P (W)	volt. (V)	HC	L (mm)	W (mm)	Ref. No.
5	415806	5200	230	2	240	390	0H6176

Eloma

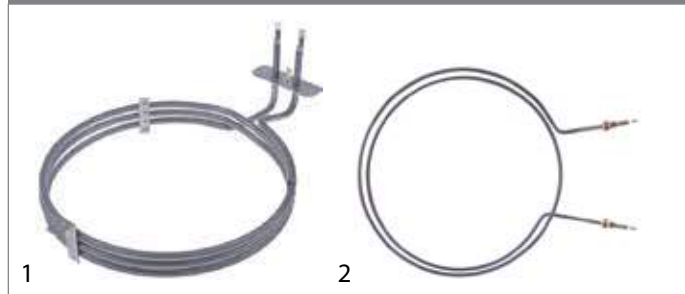

fig.	Vare nr.	P (W)	volt. (V)	L (mm)	ID ø (mm)	ED ø (mm)	Ref. No.
1	420300	3400	230	268	200	212	EL0590118
2	418766	4500	230	530	380	405	ELE318002

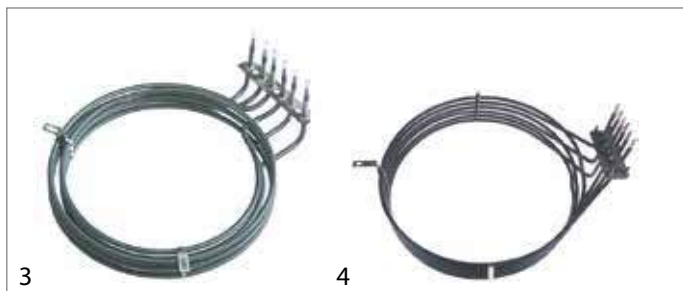

fig.	Vare nr.	P (W)	volt. (V)	L (mm)	ID ø (mm)	ED ø (mm)	Ref. No.
3	415805	5700	230	290	206	245	EL0693383
4	418739	10500	230	480	411	428	EL0742414



fig.	Vare nr.	P (W)	volt. (V)	L (mm)	ID ø (mm)	ED ø (mm)	Ref. No.
5	418959	21600	230	522	414	466	EL0742422

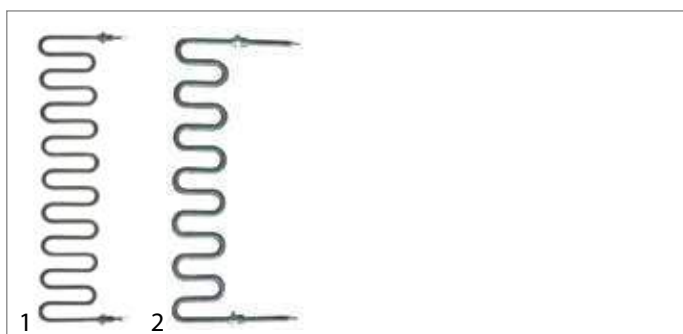

fig.	Vare nr.	P (W)	volt. (V)	HC	L (mm)	W (mm)	Ref. No.
1	415133	1430	230	1	85	395	EL0585726
1	415221	1430	230	1	90	390	EL0332429
1	415222	2300	230	1	90	395	EL0576581
1	415542	2500	230	1	131	485	ELE318084
2	415543	4000	230	1	131	485	ELE318083

Eminox



fig.	Vare nr.	P (W)	volt. (V)	L (mm)	ID ø (mm)	ED ø (mm)	Ref. No.
1	418345	1600	230	250	178	191	3710004

Emmepi



fig.	Vare nr.	P (W)	volt. (V)	L (mm)	ID ø (mm)	ED ø (mm)	Ref. No.
1	418135	920	230	255	200	215	808779
2	418861	2400	220	210	185	200	828041



fig.	Vare nr.	P (W)	volt. (V)	L (mm)	ID ø (mm)	ED ø (mm)	Ref. No.
3	418134	3300	240	215	185	200	808778
4	418131	6000	230	271	217	231	808781



fig.	Vare nr.	P (W)	volt. (V)	L (mm)	ID ø (mm)	ED ø (mm)	Ref. No.
5	418858	7350	230	267	215	230	806187

Fagor



fig.	Vare nr.	P (W)	volt. (V)	L (mm)	ID ø (mm)	ED ø (mm)	Ref. No.
1	418374	9000	230	443	407	420	12027912
2	415912	9000	230	474	445	458	12028209
2	415913	9000	230	535	504	516	12026871



fig.	Vare nr.	P (W)	volt. (V)	L (mm)	ID ø (mm)	ED ø (mm)	Ref. No.
3	417198	15000	230	605	508	515	12018441
3	415914	15000	230	615	505	520	12026971
3	417199	15000	230	670	650	668	12018381
3	415915	15000	230	696	635	650	12026880
4	418376	18000	230	477	410	477	12038126
4	418382	18000	230	485	407	485	12025968
4	418385	30000	230	655	573	630	12025672

fig.	Vare nr.	P (W)	volt. (V)	HC	L (mm)	W (mm)	Ref. No.
1	416634	1500	230	1	350	102	12024692
2	416620	3000	230	2	570	100	12024727
2	416621	4000	230	2	1155	100	12017124

fig.	Vare nr.	P (W)	volt. (V)	HC	L (mm)	W (mm)	Ref. No.
3	416019	4000	230	2	570	100	12017453

Falcon

fig.	Vare nr.	P (W)	volt. (V)	HC	L (mm)	W (mm)	Ref. No.
1	415221	1430	230	1	90	390	530332429
1	415542	2500	230	1	131	485	530318084
2	415543	4000	230	1	131	485	530318083

Foinox

fig.	Vare nr.	P (W)	volt. (V)	L (mm)	ID ø (mm)	ED ø (mm)	Ref. No.
1	418135	920	230	255	200	215	1126
2	418133	2000	220	215	187	200	0022
2	418134	3300	240	215	185	200	0508

fig.	Vare nr.	P (W)	volt. (V)	L (mm)	ID ø (mm)	ED ø (mm)	Ref. No.
3	416412	2500	230	215	188	200	0159
4	418131	6000	230	271	217	231	1023

fig.	Vare nr.	P (W)	volt. (V)	L (mm)	ID ø (mm)	ED ø (mm)	Ref. No.
5	418132	7350	230	277	250	265	3016A
5	418753	8000	230	345	287	300	10628
6	418129	16000	230	450	337	358	10638

fig.	Vare nr.	P (W)	volt. (V)	HC	L (mm)	W (mm)	Ref. No.
1	418139	3500	240	1	620	120	1466



Garbin



fig.	Vare nr.	P (W)	volt. (V)	L (mm)	ID ø (mm)	ED ø (mm)	Ref. No.
1	415966	2500	230	210	176	188	RES006
2	420295	3300	240	245	190	200	RES013-UL

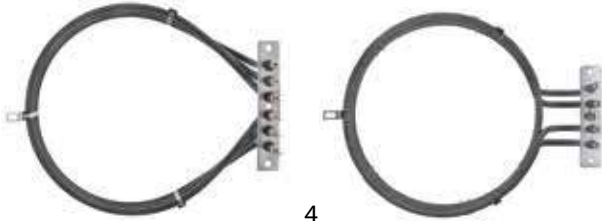

fig.	Vare nr.	P (W)	volt. (V)	L (mm)	ID ø (mm)	ED ø (mm)	Ref. No.
3	417606	4500	230	280	220	240	RES026
4	417607	2x2000	230	240	185	200	RES000

Gico



fig.	Vare nr.	P (W)	volt. (V)	L (mm)	ID ø (mm)	ED ø (mm)	Ref. No.
1	416118	2000	230	245	180	192	296201860
2	416119	2000	240	245	182	195	296201860

GIGA



fig.	Vare nr.	P (W)	volt. (V)	L (mm)	ID ø (mm)	ED ø (mm)	Ref. No.
1	416040	2500	230	212	185	198	X68002
2	415251	2500	230	242	178	190	50039



fig.	Vare nr.	P (W)	volt. (V)	L (mm)	ID ø (mm)	ED ø (mm)	Ref. No.
3	415871	6000	230	267	217	230	761344

Giorik



fig.	Vare nr.	P (W)	volt. (V)	L (mm)	ID ø (mm)	ED ø (mm)	Ref. No.
1	418858	7350	230	267	215	230	6002100
2	418086	8400	230	275	218	235	6002001

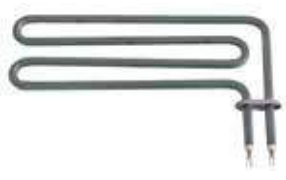

fig.	Vare nr.	P (W)	volt. (V)	L (mm)	ID ø (mm)	ED ø (mm)	Ref. No.
3	418087	15000	230/400	452	398	415	6002125

Hobart



fig.	Vare nr.	P (W)	volt. (V)	L (mm)	ID ø (mm)	ED ø (mm)	Ref. No.
1	418929	6000	240	415	395	415	845265-05
1	418930	6000	240	470	430	450	845265-04
1	418926	8000	240	328	301	317	845265-03
1	418916	9000	240	410	390	410	845265-02
1	418928	9000	240	475	458	475	845265-01
1	418927	12000	240	472	440	458	—

1

fig.	Vare nr.	P (W)	volt. (V)	HC	L (mm)	W (mm)	Ref. No.
1	418925	1500	230	1	293	106	233848-2

Hounö



1

fig.	Vare nr.	P (W)	volt. (V)	L (mm)	ID ø (mm)	ED ø (mm)	Ref. No.
1	420419	9000	240	422	395	405	20700059

Hupfer



1

fig.	Vare nr.	P (W)	volt. (V)	L (mm)	ID ø (mm)	ED ø (mm)	Ref. No.
1	418274	1500	230	225	189	202	014001107
1	418275	2000	230	220	194	207	014041047-03

Inomak



1

fig.	Vare nr.	P (W)	volt. (V)	L (mm)	ID ø (mm)	ED ø (mm)	Ref. No.
1	420035	1400	230	215	180	198	34500040100735
1	420034	1800	230	215	180	198	34500040100732

Inoxtrend

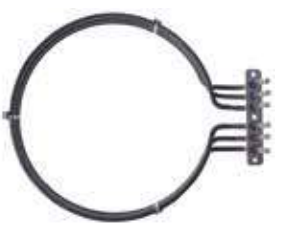
1 2



fig.	Vare nr.	P (W)	volt. (V)	L (mm)	ID ø (mm)	ED ø (mm)	Ref. No.
1	418018	2800	230	290	192	210	C6015-00
2	418019	3900	230	275	206	218	C3616-00
2	418905	8000	230	370	302	319	LC-002



3

fig.	Vare nr.	P (W)	volt. (V)	L (mm)	ID ø (mm)	ED ø (mm)	Ref. No.
3	418020	7800	230	315	264	277	LC-001

Juno

1 2

fig.	Vare nr.	P (W)	volt. (V)	L (mm)	ID ø (mm)	ED ø (mm)	Ref. No.
1	415123	1750	220	222	186	199	0H6212
1	418468	2000	230	215	192	203	0H6210
2	415116	2600	230	220	190	210	0H6157



3

fig.	Vare nr.	P (W)	volt. (V)	L (mm)	ID ø (mm)	ED ø (mm)	Ref. No.
3	415654	5666	230	580	465	480	002688
3	415656	8000	400	630	560	580	0A5330

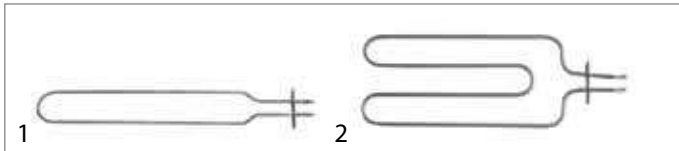



fig.	Vare nr.	P (W)	volt. (V)	HC	L (mm)	W (mm)	Ref. No.
1	415487	1000	230	1	445	65	0K0601
2	415485	2000	230	1	360	155	0H6197

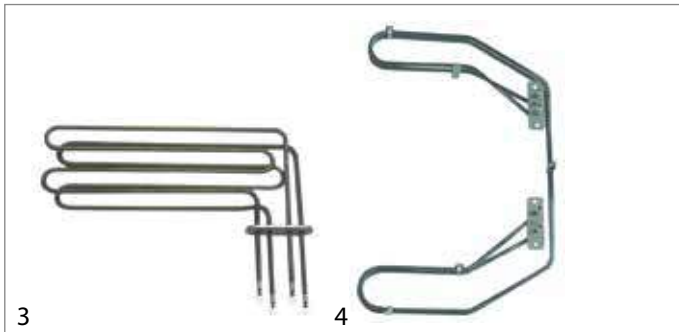

fig.	Vare nr.	P (W)	volt. (V)	HC	L (mm)	W (mm)	Ref. No.
3	415457	3000	230	2	330	135	0H6166
3	415523	3000	400	2	330	135	0H6167
4	415806	5200	230	2	240	390	0H6176

Kreffft



fig.	Vare nr.	P (W)	volt. (V)	L (mm)	ID ø (mm)	ED ø (mm)	Ref. No.
1	415602	4800	400	265	183	213	49-182662
2	415601	6000	400	240	175	210	49-182522



fig.	Vare nr.	P (W)	volt. (V)	L (mm)	ID ø (mm)	ED ø (mm)	Ref. No.
3	415829	7500	230	287	248	260	72-65011540
4	415911	9000	230	410	310	333	76-30043524



fig.	Vare nr.	P (W)	volt. (V)	L (mm)	ID ø (mm)	ED ø (mm)	Ref. No.
5	415240	9000	230	420	385	400	—
5	415241	9000	230	470	440	453	—
5	415239	9000	400	465	440	453	—
6	415912	9000	230	474	445	458	—
6	415913	9000	230	535	504	516	—



fig.	Vare nr.	P (W)	volt. (V)	L (mm)	ID ø (mm)	ED ø (mm)	Ref. No.
7	415915	15000	230	696	635	650	—

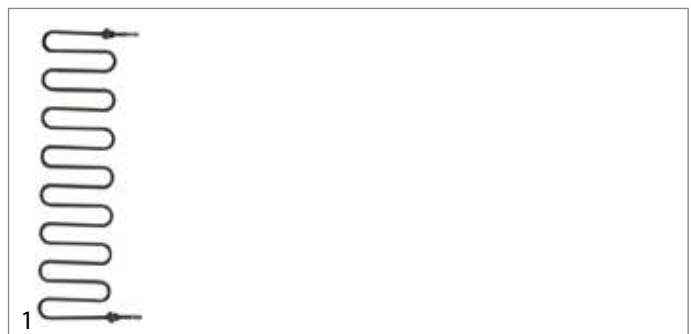

fig.	Vare nr.	P (W)	volt. (V)	HC	L (mm)	W (mm)	Ref. No.
1	415469	2000	220	1	95	520	76-30041403
1	415554	2500	230	1	148	534	—

Küppersbusch

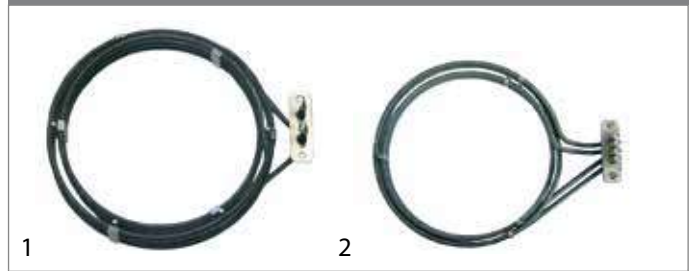



fig.	Vare nr.	P (W)	volt. (V)	L (mm)	ID ø (mm)	ED ø (mm)	Ref. No.
1	415603	4000	400	240	176	210	182324
1	415601	6000	400	240	175	210	182522
2	415602	4800	400	265	183	213	182662

3

fig.	Vare nr.	P (W)	volt. (V)	L (mm)	ID ø (mm)	ED ø (mm)	Ref. No.
3	415911	9000	230	410	310	333	407449



5

fig.	Vare nr.	P (W)	volt. (V)	L (mm)	ID ø (mm)	ED ø (mm)	Ref. No.
5	415829	7500	230	287	248	260	LAR65011540
5	415828	15000	230	428	388	408	LAR65011310
5	418197	15000	230	545	512	530	LAR65011250



1 2

fig.	Vare nr.	P (W)	volt. (V)	HC	L (mm)	W (mm)	Ref. No.
1	415469	2000	220	1	95	520	407299
1	415554	2500	230	1	148	534	407496
2	415571	3000	230	1	360	120	181740

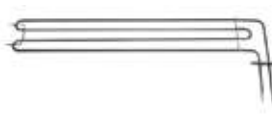

1

fig.	Vare nr.	P (W)	volt. (V)	HC	L (mm)	W (mm)	Ref. No.
1	415737	2500	230	1	655	120	LAR65010180
1	415736	3500	230	1	655	125	LAR65010390

Lainox



1 2

fig.	Vare nr.	P (W)	volt. (V)	L (mm)	ID ø (mm)	ED ø (mm)	Ref. No.
1	415845	3150	230	272	201	215	LAR65010320
2	415855	3900	230	282	176	244	LAR65010450

Lotus



1 2

fig.	Vare nr.	P (W)	volt. (V)	L (mm)	ID ø (mm)	ED ø (mm)	Ref. No.
1	415777	2000	230	245	178	190	537006500
2	418019	3900	230	275	206	218	C3616-00

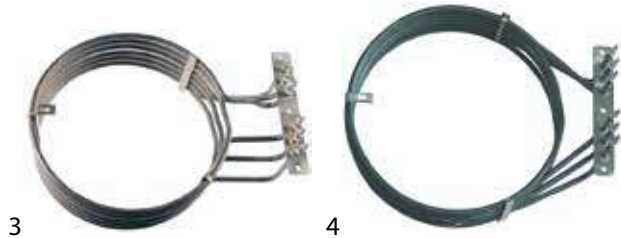

3 4

fig.	Vare nr.	P (W)	volt. (V)	L (mm)	ID ø (mm)	ED ø (mm)	Ref. No.
3	418191	5400	230	270	194	205	LAR65015830
4	418196	6000	230	266	215	228	LAR65011530
4	415871	6000	230	267	217	230	LAR65011520
4	415993	7200	230	270	215	230	LAR65010680



3

fig.	Vare nr.	P (W)	volt. (V)	L (mm)	ID ø (mm)	ED ø (mm)	Ref. No.
3	418020	7800	230	315	264	277	RRC3090-00

Marels



1

fig.	Vare nr.	P (W)	volt. (V)	L (mm)	ID ø (mm)	ED ø (mm)	Ref. No.
1	418020	7800	230	315	264	277	999.22.042



Mareno



fig.	Vare nr.	P (W)	volt. (V)	L (mm)	ID ø (mm)	ED ø (mm)	Ref. No.
1	415966	2500	230	210	176	188	MA4330700
2	415251	2500	230	242	178	190	1037300200



fig.	Vare nr.	P (W)	volt. (V)	HC	L (mm)	W (mm)	Ref. No.
1	415998	3000	400	1	513	120	MA5152100

MBM-Italia



fig.	Vare nr.	P (W)	volt. (V)	L (mm)	ID ø (mm)	ED ø (mm)	Ref. No.
1	418345	1600	230	250	178	191	RTBF900218
2	418146	2200	230	210	180	195	RTCU700451
2	415966	2500	230	210	176	188	RIC0001835
2	416842	2600	230	212	177	194	RTCU700650



fig.	Vare nr.	P (W)	volt. (V)	L (mm)	ID ø (mm)	ED ø (mm)	Ref. No.
3	419014	2700	230	247	179	192	011482-00-R
4	418143	7500	230	282	250	265	RTFOC00433



fig.	Vare nr.	P (W)	volt. (V)	L (mm)	ID ø (mm)	ED ø (mm)	Ref. No.
5	418142	21600	230	465	398	415	RTFOC00307



fig.	Vare nr.	P (W)	volt. (V)	HC	L (mm)	W (mm)	Ref. No.
1	418145	2500	230	1	600	120	RTFOC00068

MKN

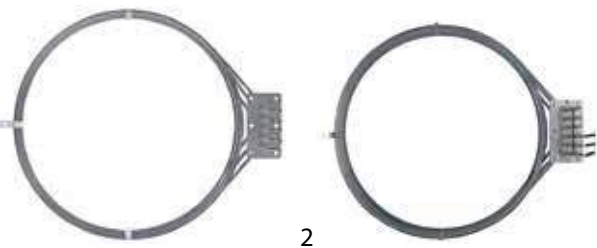

fig.	Vare nr.	P (W)	volt. (V)	L (mm)	ID ø (mm)	ED ø (mm)	Ref. No.
1	420336	9900	230	500	450	465	574160
2	418749	9900	400	500	450	465	574176



fig.	Vare nr.	P (W)	volt. (V)	L (mm)	ID ø (mm)	ED ø (mm)	Ref. No.
3	418750	15400	400	540	450	530	574177
4	418748	20400	400	107	450	525	574181



fig.	Vare nr.	P (W)	volt. (V)	L (mm)	ID ø (mm)	ED ø (mm)	Ref. No.
5	418751	30000	400	535	380	450	574189



Mobile-Containing



1

fig.	Vare nr.	P (W)	volt. (V)	L (mm)	ID ø (mm)	ED ø (mm)	Ref. No.
1	415123	1750	220	222	186	199	957226

Multinox



1 2

fig.	Vare nr.	P (W)	volt. (V)	L (mm)	ID ø (mm)	ED ø (mm)	Ref. No.
1	418317	1450	240	-	185	200	563000900
2	415966	2500	230	210	176	188	563000800

Modular

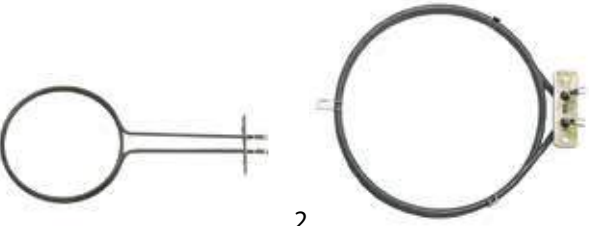

1 2

fig.	Vare nr.	P (W)	volt. (V)	L (mm)	ID ø (mm)	ED ø (mm)	Ref. No.
1	415925	1260	230	380	180	192	66500800
2	418317	1450	240	-	185	200	M563000900

Olis



1 2

fig.	Vare nr.	P (W)	volt. (V)	L (mm)	ID ø (mm)	ED ø (mm)	Ref. No.
1	416784	1300	230	245	178	194	BN6A037650
2	416788	2400	230	245	175	193	BN6A037600



3 4

fig.	Vare nr.	P (W)	volt. (V)	L (mm)	ID ø (mm)	ED ø (mm)	Ref. No.
3	416532	2300	230	212	183	197	66506100
4	415966	2500	230	210	176	188	M563000800

Palux



1 2

fig.	Vare nr.	P (W)	volt. (V)	L (mm)	ID ø (mm)	ED ø (mm)	Ref. No.
1	418766	4500	230	530	380	405	101125
2	415805	5700	230	290	206	245	693383



5

fig.	Vare nr.	P (W)	volt. (V)	L (mm)	ID ø (mm)	ED ø (mm)	Ref. No.
5	418020	7800	230	315	264	277	999.22.042



3

fig.	Vare nr.	P (W)	volt. (V)	L (mm)	ID ø (mm)	ED ø (mm)	Ref. No.
3	418739	10500	230	480	411	428	742414

Multi



1



fig.	Vare nr.	P (W)	volt. (V)	L (mm)	ID ø (mm)	ED ø (mm)	Ref. No.
1	415925	1260	230	380	180	192	665008

1

fig.	Vare nr.	P (W)	volt. (V)	HC	L (mm)	W (mm)	Ref. No.
1	415133	1430	230	1	85	395	399329
1	415221	1430	230	1	90	390	332429



Piron

1 2



fig.	Vare nr.	P (W)	volt. (V)	L (mm)	ID ø (mm)	ED ø (mm)	Ref. No.
1	418267	2500	230	208	181	193	RES30003
1	417224	3000	230	205	180	194	KRS00005
2	419024	4000	230	265	217	233	KRS00006

Rational



1 2

fig.	Vare nr.	P (W)	volt. (V)	L (mm)	ID ø (mm)	ED ø (mm)	Ref. No.
1	415911	9000	230	410	310	333	3004.3524
2	415240	9000	230	420	385	400	3004.3537
2	415241	9000	230	470	440	453	3004.3532
2	415239	9000	400	465	440	453	3004.3536



3 4

fig.	Vare nr.	P (W)	volt. (V)	L (mm)	ID ø (mm)	ED ø (mm)	Ref. No.
3	418374	9000	230	443	407	420	87.00.394
4	415912	9000	230	474	445	458	8720.1594
4	415913	9000	230	535	504	516	8720.1595

5 6



fig.	Vare nr.	P (W)	volt. (V)	L (mm)	ID ø (mm)	ED ø (mm)	Ref. No.
5	415914	15000	230	615	505	520	8720.1596
5	415915	15000	230	696	635	650	8720.1597
6	418376	18000	230	477	410	477	87.00.396
6	418382	18000	230	485	407	485	87.00.404
6	418385	30000	230	655	573	630	87.00.397

1 2

fig.	Vare nr.	P (W)	volt. (V)	HC	L (mm)	W (mm)	Ref. No.
1	415469	2000	220	1	95	520	3004.1403
1	415554	2500	230	1	148	534	3004.4111
2	415222	2300	230	1	90	395	1007.2454

Retigo

1 2

fig.	Vare nr.	P (W)	volt. (V)	L (mm)	ID ø (mm)	ED ø (mm)	Ref. No.
1	417541	4800	230	290	205	250	AX00-0016
2	417545	16000	230	460	380	430	AX00-0007



3

fig.	Vare nr.	P (W)	volt. (V)	L (mm)	ID ø (mm)	ED ø (mm)	Ref. No.
3	417546	29000	230	530	430	530	AX00-0018



Rieber

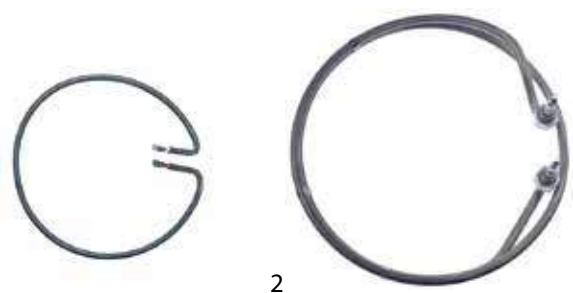

1 2

fig.	Vare nr.	P (W)	volt. (V)	L (mm)	ID ø (mm)	ED ø (mm)	Ref. No.
1	415243	415	240	170	157	170	33010105
2	420287	810	240	-	165	180	33010178

Roller Grill



1 2

fig.	Vare nr.	P (W)	volt. (V)	L (mm)	ID ø (mm)	ED ø (mm)	Ref. No.
1	416770	1500	230	256	175	188	D02144
1	416730	2500	230	253	177	189	D02143
2	420088	2400	230	162	135	145	D02158

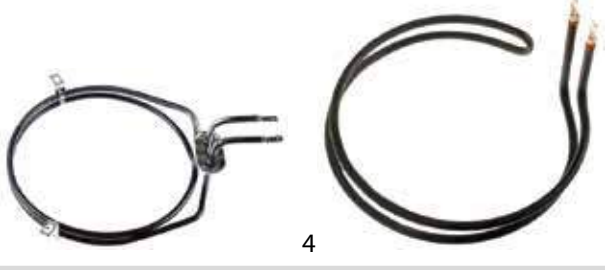

3 4

fig.	Vare nr.	P (W)	volt. (V)	L (mm)	ID ø (mm)	ED ø (mm)	Ref. No.
3	418281	1600	240	188	163	176	33010163
3	418288	2400	240	188	163	176	33010161
4	418256	1700	240	-	167	180	33010115



3 4

fig.	Vare nr.	P (W)	volt. (V)	L (mm)	ID ø (mm)	ED ø (mm)	Ref. No.
3	416773	3000	230	210	185	198	D02034
4	416774	5000	230	273	224	242	D02045



5

fig.	Vare nr.	P (W)	volt. (V)	L (mm)	ID ø (mm)	ED ø (mm)	Ref. No.
5	415246	2400	230	-	165	180	33010118



5

fig.	Vare nr.	P (W)	volt. (V)	L (mm)	ID ø (mm)	ED ø (mm)	Ref. No.
5	420087	6000	240	267	240	250	D02151

RM-Gastro



1

fig.	Vare nr.	P (W)	volt. (V)	L (mm)	ID ø (mm)	ED ø (mm)	Ref. No.
1	418662	3000	230	217	186	200	401033000

Rosinox



1 2

fig.	Vare nr.	P (W)	volt. (V)	L (mm)	ID ø (mm)	ED ø (mm)	Ref. No.
1	415251	2500	230	242	178	190	RX94806387
2	418131	6000	230	271	217	231	RX94814229

3

fig.	Vare nr.	P (W)	volt. (V)	L (mm)	ID ø (mm)	ED ø (mm)	Ref. No.
3	415911	9000	230	410	310	333	RX27307982

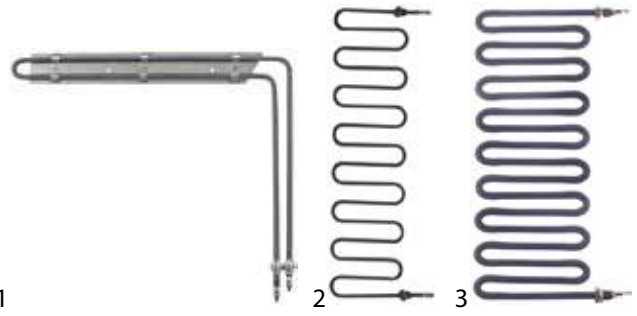

1 2 3

fig.	Vare nr.	P (W)	volt. (V)	HC	L (mm)	W (mm)	Ref. No.
1	419201	1667	230	1	405	295	Rx94032695
2	415469	2000	220	1	95	520	RX27307974
2	415554	2500	230	1	148	534	RX27307966
3	420245	3600	240	1	143	335	RX94050010

Saro



1

fig.	Vare nr.	P (W)	volt. (V)	L (mm)	ID ø (mm)	ED ø (mm)	Ref. No.
1	415124	2300	230	215	183	198	20-2057

Silko



1

fig.	Vare nr.	P (W)	volt. (V)	L (mm)	ID ø (mm)	ED ø (mm)	Ref. No.
1	415251	2500	230	242	178	190	SIR0101564

Smeg



1 2

fig.	Vare nr.	P (W)	volt. (V)	L (mm)	ID ø (mm)	ED ø (mm)	Ref. No.
1	418584	1550	230	210	180	192	806890593
2	418535	2000	230	210	180	192	—



3 4

fig.	Vare nr.	P (W)	volt. (V)	L (mm)	ID ø (mm)	ED ø (mm)	Ref. No.
3	418509	2660	230	245	210	223	806890550
4	418508	2700	230	208	181	194	806890386
4	418507	2700	230	210	180	195	806890656



5

fig.	Vare nr.	P (W)	volt. (V)	L (mm)	ID ø (mm)	ED ø (mm)	Ref. No.
5	418537	3990	230	245	222	235	806890437

SSP



1

fig.	Vare nr.	P (W)	volt. (V)	L (mm)	ID ø (mm)	ED ø (mm)	Ref. No.
1	418887	2400	240	227	179	192	0617301601



Star10

fig.	Vare nr.	P (W)	volt. (V)	L (mm)	ID ø (mm)	ED ø (mm)	Ref. No.
1	418267	2500	230	208	181	193	071041
2	415251	2500	230	242	178	190	X68002

Unox

fig.	Vare nr.	P (W)	volt. (V)	L (mm)	ID ø (mm)	ED ø (mm)	Ref. No.
1	417608	1260	230	244	178	190	KRS0090A
2	420192	1260	230	244	178	190	—

Tecnoeka

fig.	Vare nr.	P (W)	volt. (V)	L (mm)	ID ø (mm)	ED ø (mm)	Ref. No.
1	418042	1200	230	245	180	194	01951147000
1	418043	1600	230	245	180	192	09950987000
1	418044	2500	230	245	180	192	09950977000
2	419016	3000	230	265	227	240	01200800

fig.	Vare nr.	P (W)	volt. (V)	L (mm)	ID ø (mm)	ED ø (mm)	Ref. No.
3	417562	2560	230		220	235	RS0023A0
4	417561	2560	230	255	220	235	KRS0023A

Tecnoinox

fig.	Vare nr.	P (W)	volt. (V)	L (mm)	ID ø (mm)	ED ø (mm)	Ref. No.
1	415966	2500	230	210	176	188	RC00568000
2	415251	2500	230	242	178	190	RC00568000

fig.	Vare nr.	P (W)	volt. (V)	L (mm)	ID ø (mm)	ED ø (mm)	Ref. No.
5	418745	2900	230	268	220	235	KRS1090A
5	418746	2900	230	268	220	235	KRS1130A
6	419142	3100	230		220	235	KRS1026

TurboChef

fig.	Vare nr.	P (W)	volt. (V)	HC	L (mm)	W (mm)	Ref. No.
1	418717	3000	208	1	395	395	NGC-3003

fig.	Vare nr.	P (W)	volt. (V)	L (mm)	ID ø (mm)	ED ø (mm)	Ref. No.
7	418906	4250	230	265	220	235	KRS1040A
8	419111	4250	230	265	220	235	RS076

9 10

fig.	Vare nr.	P (W)	volt. (V)	L (mm)	ID ø (mm)	ED ø (mm)	Ref. No.
9	417550	4700	230	270	224	235	KRS1225A
10	417556	4900	230	270	224	235	KRS1150A

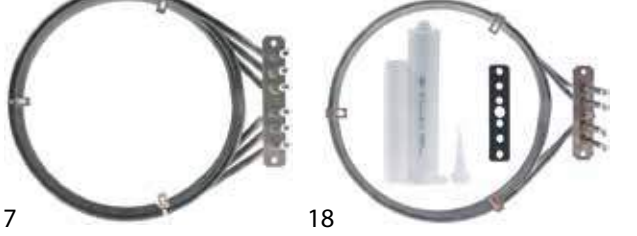

17 18

fig.	Vare nr.	P (W)	volt. (V)	L (mm)	ID ø (mm)	ED ø (mm)	Ref. No.
17	417555	9000	230	300	240	257	KRS1020A
18	420399	2200/2200	225	270	224	235	KRS0085A

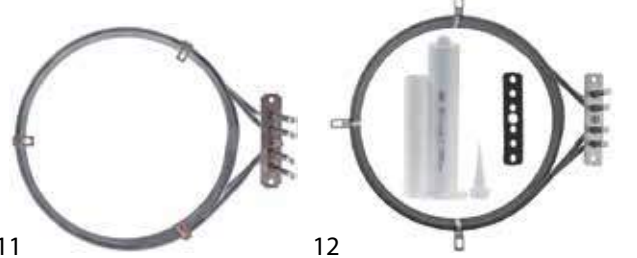

11 12

fig.	Vare nr.	P (W)	volt. (V)	L (mm)	ID ø (mm)	ED ø (mm)	Ref. No.
11	417557	4900	230	270	224	235	RS1150A0
12	419017	5000	230	265	223	236	KRS1050A

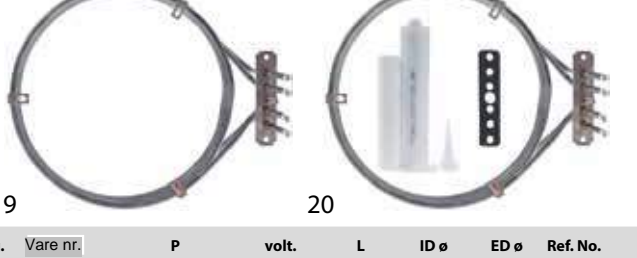

19 20

fig.	Vare nr.	P (W)	volt. (V)	L (mm)	ID ø (mm)	ED ø (mm)	Ref. No.
19	420414	2200/2200	225	270	224	235	RS085A
20	420416	2900/1450	230	270	224	235	KRS1115A

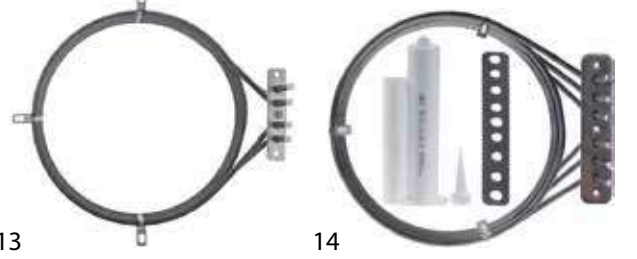

13 14

fig.	Vare nr.	P (W)	volt. (V)	L (mm)	ID ø (mm)	ED ø (mm)	Ref. No.
13	419144	5000	230	265	223	236	RS1000A0
14	417552	5600	230	270	224	235	KRS1205A



21 22

fig.	Vare nr.	P (W)	volt. (V)	L (mm)	ID ø (mm)	ED ø (mm)	Ref. No.
21	420417	2900/1450	230	270	224	235	RS1115A0
22	417563	147/1300	105/230		218	236	RS1240A0



15 16

fig.	Vare nr.	P (W)	volt. (V)	L (mm)	ID ø (mm)	ED ø (mm)	Ref. No.
15	417560	9000	230	282	220	238	KRS1180A
16	417564	9000	230	282	220	238	RS1180A0

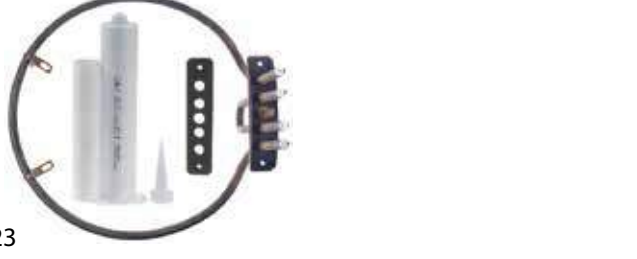

23

fig.	Vare nr.	P (W)	volt. (V)	L (mm)	ID ø (mm)	ED ø (mm)	Ref. No.
23	417558	147/1300	105/230	240	218	236	KRS1240A



1

fig.	Vare nr.	P (W)	volt. (V)	HC	L (mm)	W (mm)	Ref. No.
1	417547	90	110	1	155	31	KRS1100A

Whirlpool



fig.	Vare nr.	P (W)	volt. (V)	L (mm)	ID ø (mm)	ED ø (mm)	Ref. No.
1	415966	2500	230	210	176	188	483286000411
2	418018	2800	230	290	192	210	—

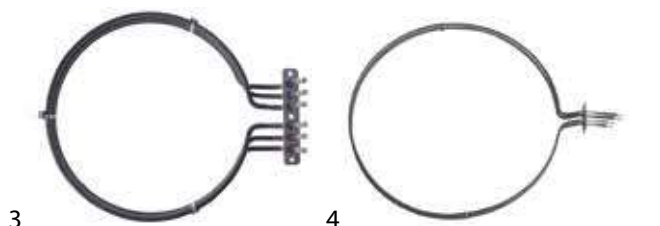

fig.	Vare nr.	P (W)	volt. (V)	L (mm)	ID ø (mm)	ED ø (mm)	Ref. No.
3	418019	3900	230	275	206	218	—
4	415654	5666	230	580	465	480	—



fig.	Vare nr.	P (W)	volt. (V)	L (mm)	ID ø (mm)	ED ø (mm)	Ref. No.
5	418020	7800	230	315	264	277	—

Wiesheu-Wiwa



fig.	Vare nr.	P (W)	volt. (V)	L (mm)	ID ø (mm)	ED ø (mm)	Ref. No.
1	415841	3000	230	220	192	205	34671
1	418633	3000	230	228	200	213	38134
2	415843	4500	230	306	240	257	36518



fig.	Vare nr.	P (W)	volt. (V)	L (mm)	ID ø (mm)	ED ø (mm)	Ref. No.
3	415823	8000	380	335	268	300	33157



fig.	Vare nr.	P (W)	volt. (V)	HC	L (mm)	W (mm)	Ref. No.
1	415833	3000	230	3	400	100	34960
1	415834	4000	230	3	400	100	34961

Zanussi



fig.	Vare nr.	P (W)	volt. (V)	L (mm)	ID ø (mm)	ED ø (mm)	Ref. No.
1	415119	1600	230	254	179	197	0A2017
2	415123	1750	220	222	186	199	0H6212
2	415118	2400	230	221	178	190	031485
2	415966	2500	230	210	176	188	004934

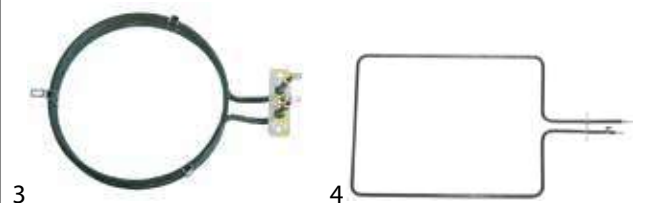

fig.	Vare nr.	P (W)	volt. (V)	L (mm)	ID ø (mm)	ED ø (mm)	Ref. No.
3	415117	2500	230	245	175	195	054843
4	415351	2500	230	544	-	-	056945





fig.	Vare nr.	P (W)	volt. (V)	L (mm)	ID ø (mm)	ED ø (mm)	Ref. No.
5	418083	3000	230	245	179	190	055503
6	415654	5666	230	580	465	480	002688
6	415389	5666	230	590	470	487	058197
6	418151	5670	400	585	467	483	0C5364
6	415656	8000	400	630	560	580	0A5330
6	418152	8000	400	700	569	580	0C5365

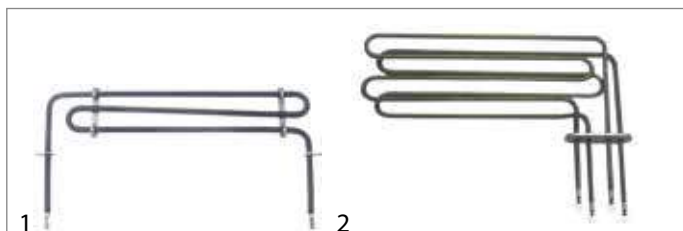

fig.	Vare nr.	P (W)	volt. (V)	HC	L (mm)	W (mm)	Ref. No.
1	420468	1375	230	1	370	87	0E5126
2	415523	3000	400	2	330	135	0H6167

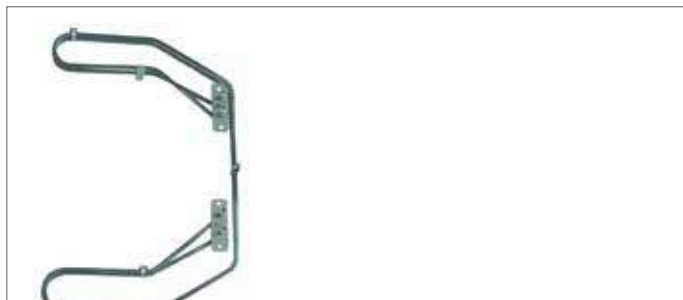



fig.	Vare nr.	P (W)	volt. (V)	HC	L (mm)	W (mm)	Ref. No.
3	415806	5200	230	2	240	390	0H6176

radiation heaters



pos.	Vare nr.	P (W)	volt. (V)	L (mm)	W (mm)	HC
1	490151	2100	230	230	230	1
2	416963	2400	230	230	230	1
3	490152	2500	230	250	250	2
4	490079	3400	230	300	300	2
5	490153	3400	230	300	300	2

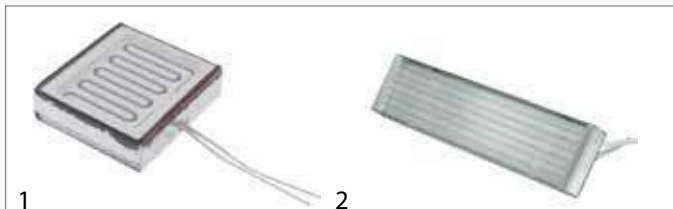



fig.	Vare nr.	L (mm)	W (mm)	P (W)	volt. (V)
1	415112	150	135	600	230
2	415308	248	60	400	230

square



pos.	Vare nr.	L (mm)	W (mm)	P (W)	volt. (V)	type
1	490168	300	290	3500	400	without pan detection
2	490144	300	300	2500	400	without pan detection
3	490159	300	300	3500	230	without pan detection
4	490143	300	300	3500	400	with pan detection
5	490145	300	300	3500	400	without pan detection
6	490009	300	300	4000	400	with pan detection
7	490202	300	300	4000	400	with pan detection
8	490008	300	300	4000	400	without pan detection
9	490195	300	300	4000	400	without pan detection



fig.	Vare nr.	P (W)	volt. (V)	L (mm)	W (mm)
1	416001	1500	230	265	165
2	418029	1500	230	450	190
2	490198	2300	230	320	230
2	416998	2700	230	410	165
2	490147	3500	230	300	570
2	416897	3500	400	415	275
2	419180	3500	400	415	275
2	418230	4000	230	425	265
2	416656	4000	230	490	245
2	490172	4500	400	280	400
2	416999	5000	230	410	280
2	490156	7500	400	280	400
2	418000	9000	400	432	340



1-circuit



fig.	Vare nr.	ø (mm)	P (W)	volt. (V)
1	490024	165	1200	230
1	490025	200	1700	230
1	490026	230	2100	230
2	490041	165	1200	230



fig.	Vare nr.	ø (mm)	P (W)	volt. (V)
3	490045	165	1200	230
3	490046	200	1700	230
3	490047	230	2100	230



fig.	Vare nr.	ø (mm)	P (W)	volt. (V)
5	490042	200	1800	230
5	490043	230	2300	230



fig.	Vare nr.	ø (mm)	P (W)	volt. (V)
7	490150	250	2500	230

2-circuit

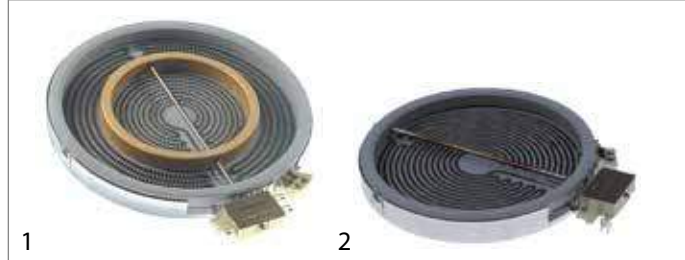

fig.	Vare nr.	ø (mm)	P (W)	volt. (V)
1	490119	200	1700	230
1	490044	230	2200	230
1	490134	230	2200	230
1	490135	230	2200	230
1	490182	230	2200/1000	400
1	490139	250	2500	230
2	490180	200	1800/900	400



fig.	Vare nr.	ø (mm)	P (W)	volt. (V)
3	490028	230	2100	230
3	490114	230	2200	230
3	490146	250	2500	230

flow heaters

Animo

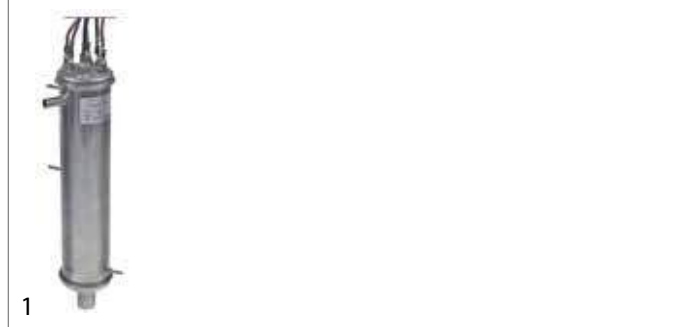

fig.	Vare nr.	P (W)	volt. (V)	ø (mm)	L (mm)	W (mm)	Ref. No.
1	417361	9000	230/400	58	320	-	03223

Bonamat



fig.	Vare nr.	P (W)	volt. (V)	ø (mm)	L (mm)	W (mm)	Ref. No.
1	417204	1710	240	82	123	87	6.000.201.675
2	417320	2160	240	82	105	-	6.301.002.000



fig.	Vare nr.	P (W)	volt. (V)	ø (mm)	L (mm)	W (mm)	Ref. No.
3	417203	2160	240	82	122	87	6.000.201.652
4	417407	6540	240	100	220	105	6.000.205.582

Bourgeois



fig.	Vare nr.	P (W)	volt. (V)	ø (mm)	L (mm)	W (mm)	Ref. No.
1	416501	3000	230	38	204	-	RC701

CoffeeQueen



fig.	Vare nr.	P (W)	volt. (V)	ø (mm)	L (mm)	W (mm)	Ref. No.
1	417480	2200	230	68	104	-	1205101

Cookmax



fig.	Vare nr.	P (W)	volt. (V)	ø (mm)	L (mm)	W (mm)	Ref. No.
1	417214	1000	220	88	110	-	0V2506
2	417457	1300	230	56	155	-	10820

EGO



fig.	Vare nr.	P (W)	volt. (V)	ø (mm)	L (mm)	W (mm)	Ref. No.
1	416501	3000	230	38	204	-	28.08020.600

Melitta



fig.	Vare nr.	P (W)	volt. (V)	ø (mm)	L (mm)	W (mm)	Ref. No.
1	417457	1300	230	56	155	-	10820
1	417350	1800	230	55	152	-	10819
2	525428	3100	230	56	300	-	12588

N&W



fig.	Vare nr.	P (W)	volt. (V)	ø (mm)	L (mm)	W (mm)	Ref. No.
1	417214	1000	220	88	110	-	0V2506

foil heating elements

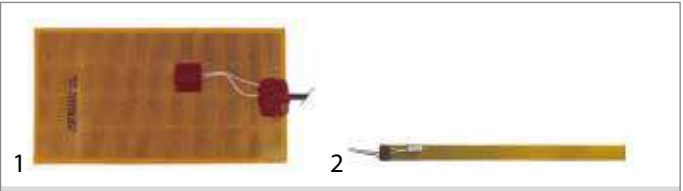

fig.	Vare nr.	P (W)	volt. (V)	L (mm)	W (mm)	t.max. (°C)	suitable for
1	416416	80	230	240	130	-	Dexion MBM-Italia
2	416315	87	230	470	65	80	Dexion MBM-Italia

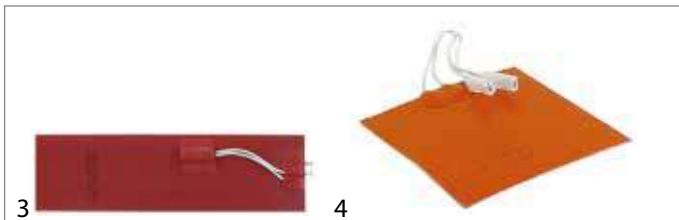



fig.	Vare nr.	P (W)	volt. (V)	L (mm)	W (mm)	t.max. (°C)	suitable for
3	418855	100	220	210	58	130	Infrico
4	416249	100	230	120	120	-	Aristarco

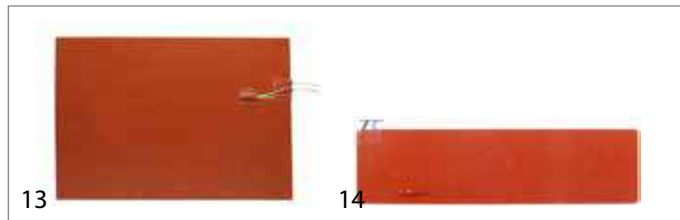

fig.	Vare nr.	P (W)	volt. (V)	L (mm)	W (mm)	t.max. (°C)	suitable for
13	415210	500	230	400	290	140	Rieber
14	420299	545	230	360	95	-	Hobart

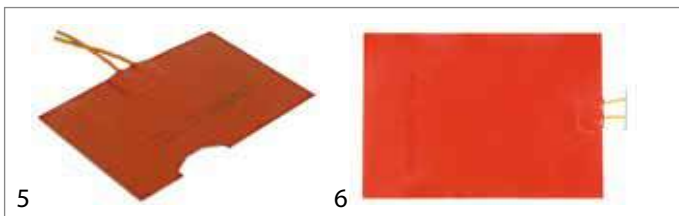

fig.	Vare nr.	P (W)	volt. (V)	L (mm)	W (mm)	t.max. (°C)	suitable for
5	416236	130	230	130	84	175	Colged Elektrobar
6	418262	150	230	195	140	175	Naomi-Grills



fig.	Vare nr.	P (W)	volt. (V)	L (mm)	W (mm)	t.max. (°C)	suitable for
15	416395	600	230	310	115	185	—
16	420405	600	230	310	115	185	Winterhalter

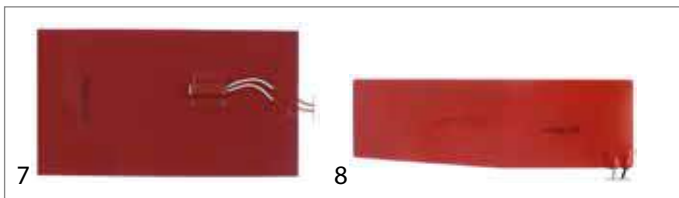

fig.	Vare nr.	P (W)	volt. (V)	L (mm)	W (mm)	t.max. (°C)	suitable for
7	418856	200	220	210	116	130	Infrico
8	420355	305	240	288	87	-	Hobart

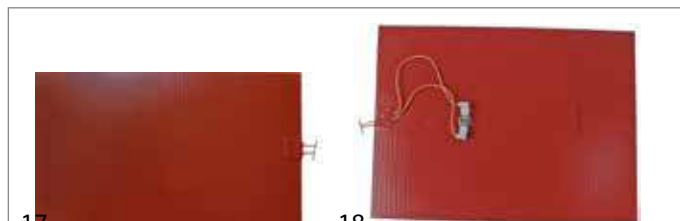

fig.	Vare nr.	P (W)	volt. (V)	L (mm)	W (mm)	t.max. (°C)	suitable for
17	418868	600	230	460	270	-	Tecfrigo
18	418623	650	230	375	275	150	—

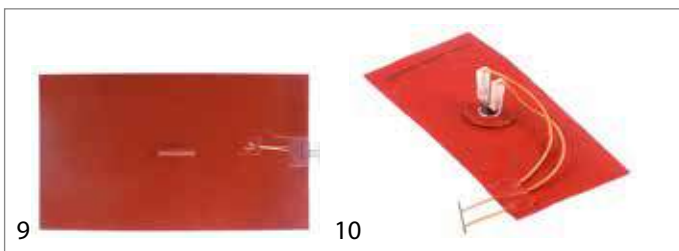

fig.	Vare nr.	P (W)	volt. (V)	L (mm)	W (mm)	t.max. (°C)	suitable for
9	418842	400	230	480	280	-	Emainox
10	416372	450	230	220	110	-	Luxia

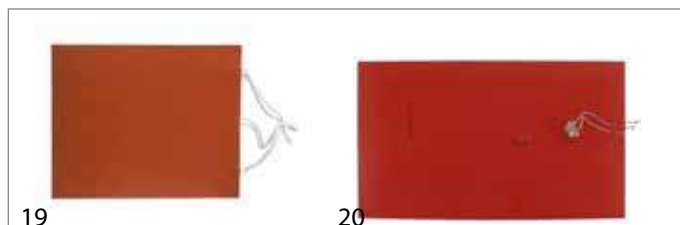

fig.	Vare nr.	P (W)	volt. (V)	L (mm)	W (mm)	t.max. (°C)	suitable for
19	415980	650	230	375	275	175	Lotus
19	415981	1100	230	460	375	175	Lotus
20	420439	700	220	460	270	150	Mareno

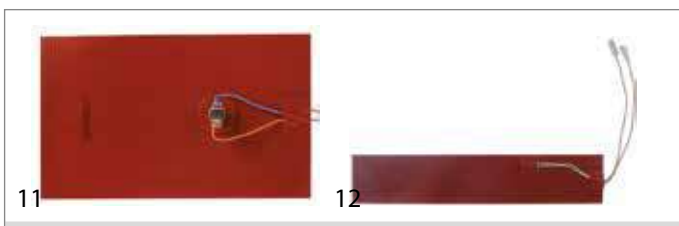

fig.	Vare nr.	P (W)	volt. (V)	L (mm)	W (mm)	t.max. (°C)	suitable for
11	418763	500	230	290	175	150	Electrolux Zanussi
12	419007	500	230	380	73	140	Comenda Hoonved

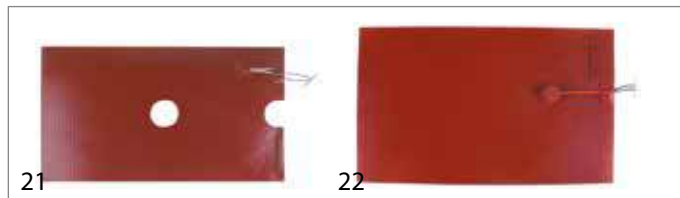

fig.	Vare nr.	P (W)	volt. (V)	L (mm)	W (mm)	t.max. (°C)	suitable for
21	418867	900	230	450	250	150	—
22	416406	1000	230	400	240	150	GIGA Nayati

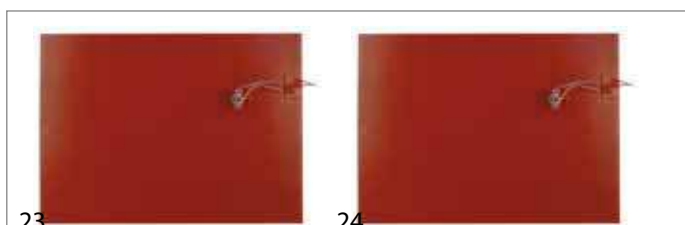

fig.	Vare nr.	P (W)	volt. (V)	L (mm)	W (mm)	t.max. (°C)	suitable for
23	416371	1000	230	400	290	140	Afinox Electrolux Öztiryakiler Zanussi
24	419075	1000	230	400	290	150	Cooking-Systems Macfrin



fig.	Vare nr.	P (W)	volt. (V)	L (mm)	W (mm)	t.max. (°C)	suitable for
27	418034	1500	230	400	290	175	Baron
27	418035	2300	230	490	400	175	Baron

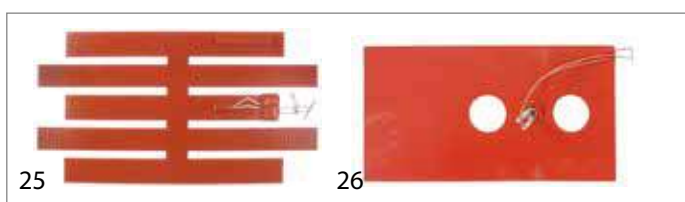



fig.	Vare nr.	P (W)	volt. (V)	L (mm)	W (mm)	t.max. (°C)	suitable for
25	420273	1000	230	450	238		Scholl
26	416687	1000	230	460	250	175	Offcar
26	416688	1350	230	500	290	175	Offcar

accessories

assortment cases



10x M10x1
10x M12x1
10x M14x1
5x 1/4"
3x 1/2"
2x 1"
2x 1 1/4"
2x 1 1/2"

5x ø12mm
10x ø14mm / 1/4"
3x 1/4"
3x 1/2"
3x 1"
3x 1 1/4"
2x 1 1/2"

(EPDM)
10x ø10mm
5x ø38,5m
5x ø47,5m
5x ø67,5m

(Fiber) (fibra) (fibra) (fibra)
10x ø10mm
10x ø12mm
10x ø14mm / 1/4"
5x 1/4"
5x 1/2"
5x 1"
5x 1 1/4"
5x 1 1/2"

(PTFE)
2x ø40mm
2x ø42mm / 1 1/4"
2x ø48mm
2x ø60mm / 1 1/2"

2x (Fiber) (fibra) (fibra) (fibra)
2x (PTFE)

2x 70x22mm (Fiber) (fibra) (fibra) (fibra)
2x 70x22mm (Silikon) (silicone) (silicone)

1x 80ml (Silikon) (silicone) (silicone)

fig.	Vare nr.	description
1	403584	assortment case heating element accessories

hexagonal nuts



fig.	Vare nr.	TS	WS	H (mm)	material
1	560130	M3	5.5	2.4	SS
2	527169	M3	5.5	2.8	brass
2	521103	M4	7	3	brass
1	560131	M4	7	3.2	SS
1	560132	M5	8	4	SS
3	520231	M10x1	14	6	zinc-coated steel
1	521129	M10	17	6	SS
2	540436	M10	13	4	brass
3	520229	M12x1	16	4	zinc-coated steel
1	521131	M12x1	17	3.5	SS

washers



pos.	Vare nr.	ID ø (mm)	ED ø (mm)	material	Qty (pcs)	for thread	T (mm)
1	560110	3.2	7	SS	20	M3	0.5
2	521104	4.3	8	brass	20	M4	0.5
3	560111	4.3	9	SS	20	M4	0.8
4	560112	5.3	10	SS	20	M5	1
5	560333	6.4	12	SS	1	M6	1.6
6	560113	6.4	12	SS	20	M6	1.6

tooth lock washers



pos.	Vare nr.	ID ø (mm)	ED ø (mm)	material	Qty (pcs)	for thread
1	560571					
2	560125	4.2	8	SS	20	M4
3	560192	10.4	18	SS	1	M10
4	520228	15.3	24	steel	1	M14

ring nuts



fig.	Vare nr.	TS	suitable for	Ref. No.
1	550662	M54x1.5	Emmepi Mareno Offcar Rosinox Silko	808892 MACM021600 862047 RX94805330 SIR0108738

retaining rings



fig.	Vare nr.	description
1	691621	retaining ring shaft ø 40mm thickness 1,8mm steel
2	510244	retaining ring shaft ø 60mm thickness 2mm steel

various



fig.	Vare nr.	description
1	550329	screw connection M14x1,5 for pipe ø 8,5mm H 23mm
2	417323	blind screw connection M10x1 WS 10 H 12mm brass
3	520211	reducer IT 1½" ET 2" brass
4	521004	hexagonal nut M36x1,5 WS 46 H 14mm brass

sealing washers

fibre gaskets



pos.	Vare nr.	D1 ø (mm)	D2 ø (mm)	T (mm)	pos.	Vare nr.	D1 ø (mm)	D2 ø (mm)	T (mm)
1	507332	18	12	2	12	540796	50	60	2
2	510416	19	10.5	1.5	13	528017	53	42	2
3	521110	20	13	2	14	528171	55	42	2
4	510417	20	14	2	15	510405	56	42	2
5	521137	20	18	1.5	16	528001	56.5	41.8	3.2
6	528401	22	16	2	17	528488	57	42	3
7	521122	31	21.5	2	18	528304	58	46	2
8	503106	32	26	3	19	529484	58	50	2
9	510403	36.5	27	2	20	510406	60	48	3
10	510404	44	34	2	21	528804	66	56	2
11	510459	50	40	3	22	510407	78	60	2

rubber gaskets

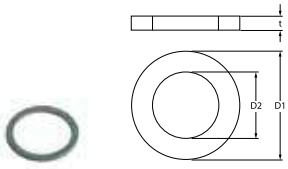

pos.	Vare nr.	D1 ø (mm)	D2 ø (mm)	T (mm)
1	521124	52	42.5	4

copper gaskets

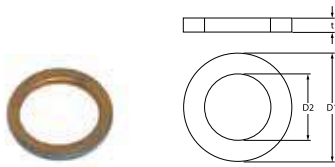

pos.	Vare nr.	D1 ø (mm)	D2 ø (mm)	T (mm)	pos.	Vare nr.	D1 ø (mm)	D2 ø (mm)	T (mm)
1	510414	18	14	1	3	510422	37.7	32.5	2.7
2	510421	31.8	26.4	2.2	4	510424	55	48	2.2

PTFE gaskets

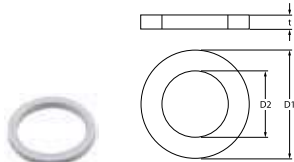

pos.	Vare nr.	D1 ø (mm)	D2 ø (mm)	T (mm)
1	528011	14.5	10	2
2	528885	26	17	2
3	528018	41	33	3
4	514016	45	40	4
5	550674	46	36	4
6	550673	46	36/38.2	5
7	526460	50	36	2
8	528007	50	40	2.5
9	528857	50	40	3.2
10	528022	52	41	2
11	528021	53	42.5	3
12	528010	56	46.5	3
13	528002	57	42	3
14	527156	57.8	43.3	2
15	528004	58	50	2
16	528003	59	45	2
17	528925	59.5	42	3
18	528805	68	55	2.4

O-rings

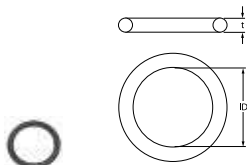

pos.	Vare nr.	material	T (mm)	ID ø (mm)	Qty (pcs)
1	510901	EPDM	2	13	1
2	510418	EPDM	2.62	9.92	1
3	532049	EPDM	2.62	9.92	10
4	511508	EPDM	2.62	12.37	10
5	511509	EPDM	2.62	13.95	10
6	510563	EPDM	3	28	1
7	510072	EPDM	3.53	32.93	1
8	510899	EPDM	3.53	37.69	1
9	510898	EPDM	3.53	39.69	1
10	528847	EPDM	3.53	47.22	1

pos.	Vare nr.	material	T (mm)	ID ø (mm)	Qty (pcs)
11	532113	EPDM	3.53	49.21	10
12	521120	EPDM	5.34	37.47	1
13	532155	EPDM	5.34	37.47	10
14	505092	EPDM	5.34	43.82	1
15	510408	EPDM	5.34	47	1
16	532158	EPDM	5.34	47	10
17	510409	EPDM	5.34	56.52	1
18	532161	EPDM	5.34	56.52	10
19	532162	EPDM	5.34	59.69	10
20	510410	EPDM	5.34	75.57	1
21	510560	EPDM	6	200	1
22	521121	EPDM	8	62	1
23	532484	silicone	2.62	37.77	1
24	417205	silicone	3	74	1
25	514017	silicone	3.53	32.93	1
26	532319	silicone	3.53	37.69	10
27	514021	silicone	3.53	49.21	1
28	510562	silicone	5.34	47	1
29	532375	silicone	5.34	47	10
30	528231	Viton	2.62	12.37	1
31	532544	Viton	3.53	37.69	1
32	550494	Viton	3.53	47.22	1
33	512398	Viton	3.53	47.22	10
34	532545	Viton	3.53	49.21	1
35	550496	Viton	3.53	50.39	1
36	512399	Viton	3.53	50.39	10
37	510245	Viton	3.53	50.8	1
38	510243	Viton	3.53	55.56	1
39	521116	Viton	3.53	78.97	1
40	550675	Viton	6	47	1

miscellaneous



fig.	Vare nr.	material	T (mm)	ID ø (mm)	Qty (pcs)	suitable for
1	511661	silicone	6	46	1	Meiko
2	550692	silicone	7	193.7	1	Baron Olis

flange gaskets



fig.	Vare nr.	L (mm)	W (mm)	suitable for
1	691014	105	55	Fagor
2	502004	235	92	Winterhalter

fig.	Vare nr.	L (mm)	W (mm)	T (mm)	suitable for
1	550937	71	21	1	Smeg Tecnoeka Wiesheu-Wiwa
2	550992	87	57	3	Convotherm
3	528090	100	22	1	Tecnoeka
4	511952	109	124	3	Bourgeois
4	511688	115	114	4	Bourgeois
4	511687	138	107	4	Bourgeois

fig.	Vare nr.	L (mm)	W (mm)	T (mm)	suitable for
12	698523	155	24.5	2.2	Hounö
12	521071	210	24	2	Retigo
12	521127	210	24	2	Fagor Krefft Rational
13	550069	210	46	2	Fagor

fig.	Vare nr.	L (mm)	W (mm)	T (mm)	suitable for
5	551258	130	88	2	Retigo
6	550696	140	62	2	Fagor Rational

fig.	Vare nr.	L (mm)	W (mm)	T (mm)	suitable for
1	550256	75	50	3	Electrolux Juno Zanussi
2	550893	81	81	4	Fagor Rational
3	550994	105	60	3	Fagor

fig.	Vare nr.	L (mm)	W (mm)	T (mm)	suitable for
1	520562	44	21	4	Hounö
2	550761	69	22	2	Fagor
3	510368	70	23.5	2	Bartscher Giorik
4	510426	72	20	2	Electrolux Juno Zanussi

fig.	Vare nr.	L (mm)	W (mm)	T (mm)	suitable for
4	550894	122	101	4	Fagor Rational
5	550257	137	79	3.5	Electrolux Juno Zanussi
6	521126	146	82	4	Krefft Rational

fig.	Vare nr.	L (mm)	W (mm)	T (mm)	suitable for
5	550986	100	22	1	Cookmax Unox
6	550760	100	22	2	Fagor
7	520598	100	25	1.4	Falcon
8	521072	112	22	2	Retigo

fig.	Vare nr.	ID ø (mm)	material	T (mm)	Hø (mm)	HD (mm)	suitable for
1	507048	30	silicone	3	10	41	Omniwash
2	528013	40	fibre	4	11	57	—
3	528340	40.5	fibre	3	10	52	Azkoyen Marcfi Pavoni
3	528027	41	fibre	2	10	50	—
4	526674	41	fibre	2	7.5	52	Gaggia

fig.	Vare nr.	L (mm)	W (mm)	T (mm)	suitable for
9	531270	141	22	1	Unox
10	550548	144	25.5	2.2	Giorik
11	550684	150	30	2	Angelo-Po





fig.	Vare nr.	ID ø (mm)	material	T (mm)	Hø (mm)	HD (mm)	suitable for
5	528740	44	PTFE	3.5	9.5	58	Aurora Brasilia Brugnetti Italcrem La-Scala SV-Italia Vibiemme Visacrem
6	528015	55	fibre	2	8	62	La-Spaziale



fig.	Vare nr.	ID ø (mm)	ED ø (mm)	HD (mm)	Hø (mm)	material	T (mm)	suitable for
1	528900	61.5	111	50	8	plastic	3.1	—
2	501383	102	144	33	6	EPDM	3	Meiko
3	520323	160	200	90/180	7	silicone		EGO Nayati Salvis Scholl Thielmann

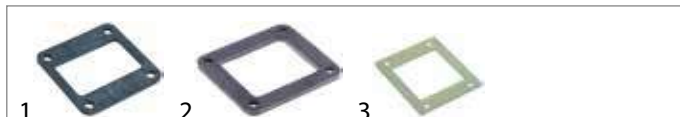

fig.	Vare nr.	material	L (mm)	W (mm)	T (mm)	Hø (mm)	HD (mm)	suitable for
1	510565	rubber	82	82	4	9	64	Fagor Krefft Rational
2	520580	rubber	96	84	5	7	65x78	Retigo
3	510745	silicone	73	62	3	4	62/55	Lohberger



fig.	Vare nr.	ID ø (mm)	ED ø (mm)	HD (mm)	Hø (mm)	material	T (mm)	suitable for
4	520324	160	200	90/180	7	SS		EGO Ilsa Nayati Salvis Thielmann



fig.	Vare nr.	material	L (mm)	W (mm)	T (mm)	Hø (mm)	HD (mm)	suitable for
1	510401	rubber	88	73	5	7	65	Elframo Komel



fig.	Vare nr.	L (mm)	W (mm)	ø (mm)	suitable for
1	510387	46	22	-	Bonamat Cookmax Electrolux Elettrobar Lincat Rancilio Zanussi
2	510388	43	21	-	Bonamat
3	510364	-	-	36	Küppersbusch Meiko
4	510365	-	-	36	—
5	521128	66	21	-	Cookmax Elettrobar GIGA Rancilio Rosinox



fig.	Vare nr.	material	D1 ø (mm)	D2 ø (mm)	T (mm)	Hø (mm)	HD (mm)	suitable for
1	528019	fibre	39	76	2	9	39	Bezzera
1	529496	fibre	54	98	3	6.7	55	La Cimbali
1	528005	fibre	96	56	3.5	9	54	Cimsa
2	528431	fibre	46	93	3.5	10	60	—



fig.	Vare nr.	L (mm)	W (mm)	HD (mm)	number of holes (holes)	suitable for
1	510429	76	23	25	3	Sammic



fig.	Vare nr.	material	D1 ø (mm)	D2 ø (mm)	T (mm)	Hø (mm)	HD (mm)	suitable for
1	528437	fibre	99	66	2	11	69/65	Conti
1	528438	PTFE	99	68	2	12	68	Conti
2	512237	cork	114	91	2	6	113/80	Hoonved



fig.	Vare nr.	L (mm)	W (mm)	suitable for
1	520546	45	22	Bonamat



fig.	Vare nr.	L (mm)	W (mm)	Hø (mm)	HD (mm)	T (mm)	suitable for
1	901629	101	83	6	-	5	Electrolux

counterflanges



fig.	Vare nr.	description	suitable for
1	510365	counterflange ø 36mm	—
2	520237	flange ø 63mm	—
3	520236	flange for heating element ID ø 50mm ED ø 90mm	Electrolux Juno Zanussi
4	520324	counterflange ID ø 160mm ED ø 200mm	EGO Ilsa Nayati Salvis Thielmann



fig.	Vare nr.	description	suitable for
5	508080	flange	Aristarco



fig.	Vare nr.	description	suitable for	Ref. No.
1	550361	blind flange 1½"	EGO	00.00615.103
2	550362	blind flange ø 64mm mounting ø 47,5mm	EGO	00.02410.641
3	550003	tension strap H 20mm L 26mm W 14mm	EGO Krefft	27.24039.000 026242
4	550002	tension strap H 10mm L 21mm W 10mm hole ø 6,5mm	Angelo-Po Aristarco Ascobloc Dihl EGO Kromo Küppersbusch Meiko Univer-Bar	3113780 00001209 9294008 DW16045 27.24031.000 DW16045 144280 0101183 3136

terminals



fig.	Vare nr.	description	suitable for	Ref. No.
1	550118	porcelain terminal block for E1 heating rods	EGO	37.33501.000
2	550119	porcelain terminal block for E1 heating rods	EGO	37.05061.000
3	550120	porcelain terminal block for E2 heating rods	EGO	38.05021.000

power sockets



fig.	Vare nr.	description	suitable for	Ref. No.
1	550405	power socket 2-pole + earthing male faston 6,3mm	EGO Küppersbusch	27.24002.510 184583
1	550404	power socket I-II phase 240V max. 16A countries I	Capic EGO	E150565 27.24002.010

capillary tube clips





fig.	Vare nr.	for pipe ø (mm)	Qty (pcs)	fig.	Vare nr.	for pipe ø (mm)	Qty (pcs)
1	551105	6	1	2	550980	8.5	1
1	551251	6	5	2	522108	8.5	10

spring clips



pos.	Vare nr.	for pipe ø (mm)	for probe ø (mm)	Qty (pcs)
1	550498	8.5	4	1
2	522106	8.5	4	5
3	550419	8.5	6	1
4	522105	8.5	6	5



fig.	Vare nr.	for pipe ø (mm)	for probe ø (mm)	Qty (pcs)
1	550539	8.5	4	1
1	551250	8.5	4	5
2	550039	8.5	3.1	1
2	551249	8.5	3.1	5
3	550006	8.5	4	1
3	522104	8.5	4	5
4	550981	8.5	6	1
5	550005	17x6	6	1
5	551248	17x6	6	5
6	550417	2x8,5	6	1
6	522107	2x8,5	6	5

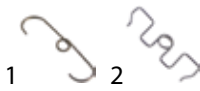

fig.	Vare nr.	for pipe ø (mm)	for probe ø (mm)	L (mm)	Qty (pcs)
1	550398	2x8,5	4	42	1
2	551025	2x8,5	6	36	1



clamps



pos.	Vare nr.	for pipe ø (mm)	for probe ø (mm)	Qty (pcs)
1	550878	-	6	1
2	550136	-	6	10
3	550877	-	8	1
4	550137	-	8	10



pos.	Vare nr.	for pipe ø (mm)	for probe ø (mm)	Qty (pcs)
1	550556	2x8,5	-	1



fig.	Vare nr.	for pipe ø (mm)	for probe ø (mm)	Qty (pcs)
1	550930	8.5	6	1
1	550135	8.5	6	10



pos.	Vare nr.	for pipe ø (mm)	for probe ø (mm)	Qty (pcs)
1	550117	8.5	6	1



fig.	Vare nr.	for pipe ø (mm)	for probe ø (mm)	Qty (pcs)
1	550043	17x6	6	1

protection caps



fig.	Vare nr.	description	suitable for
1	510094	protection cap	Elettrobar
2	510490	protection cap for heating element ø 62mm H 54mm	Comenda Mareno
3	520357	protection cap for flange ø 57,5mm ø 62mm H 42mm	Angelo-Po Comenda Fagor Hoonved



fig.	Vare nr.	description	suitable for
4	550444	protection cap ø 47mm H 40mm	Adler
5	520240	protection cap aluminium	—
6	550304	cable gland PG11 cable ø 8,0-10,0mm	—
7	550322	nut PG11 Qty 5 pcs nickel-plated brass WS 21	—



fig.	Vare nr.	description	suitable for
8	520328	protection cap for heating element	Meiko
9	501120	protection cap	Meiko
10	511923	protection cap for heating element M12	NuovaSimonelli Omniwash
11	520332	protection cap for heating element	Omniwash



fig.	Vare nr.	description	suitable for
12	501084	protection cap ø 66,5mm mounting distance 93mm	Meiko
13	520245	protection cap PVC	Meiko
14	510093	protection cap	Cookmax Elettrobar GIGA Rancilio



fig.	Vare nr.	description	suitable for
15	520226	protection cap suitable for heating element	ATA
16	511486	cover H 47mm W 80mm L 98mm	Elframo
17	510084	protection cap	Elettrobar



fig.	Vare nr.	description	suitable for
18	510034	protection cap for heating element ø 53mm	Fagor

fig.	Vare nr.	description	suitable for	Ref. No.
1	505208	bracket for heating element	Fagor	12022859
2	692061	bracket for heating element angled L 31mm W 73mm	Fagor	12002327
3	514163	bracket for heating element L 320 mm W 45 mm	Fagor	12014666
4	850030	ceramic plate curved	Cookmax Potis	PT0106 PT0106

pos.	Vare nr.	L (mm)	CS (mm ²)	connection
1	401088	1400	2.5	cable lug ø4mm
2	401703	1400	4	cable lug ø4mm

COFFEE MACHINES

ANY PART JUST A CLICK AWAY
IN THE GEV WEBSHOP

