



Reservedele til

**PALUX**

2018





## heating elements

## pilot heating elements



1

Varenummer Varenummer	415607	Ref. No.	702188
<b>description</b>	heating element 500W 230V heating circuits 1 thread 3/4" L 295mm W 20mm H 19mm length thermostat sleeves 235mm thermostat sleeves ø 6mm number of thermostat sleeves 1 thermostat sleeve clinging tube ø 6.5mm immersion heater flange with thread connection length 50mm pilot heating element		
<b>For models:</b>	00443x, 00457x, 136581, 690570		
<b>spare parts for</b>	415607		
	Varenummer Varenummer	510403	Ref. No. —
	flat gasket fibre ED ø 36.5mm ID ø 27mm thickness 2mm Qty 1 pcs		
<b>accessories for</b>	415607		
	Varenummer Varenummer	510421	Ref. No. —
	gasket copper ED ø 31.8mm ID ø 26.4mm thickness 2.2mm for thread 3/4"		
	Varenummer Varenummer	520234	Ref. No. —
	nut thread 3/4" H 5mm brass WS 30 Qty 1 pcs		

## heating elements for convection





1

Varenummer Varenummer	418739	Ref. No.	722414 742414
<b>description</b>	heating element 10500W 230V heating circuits 3 ID ø 411mm ED ø 428mm L 480mm H 110mm L1 52mm W1 99mm H1 18mm H2 92mm flange length 130mm flange width 54mm hole distance 55mm connection M5 connection length 96mm tube ø 8.5mm convection heating element mounting thread M6 rectangular flange with thread bolt		
<b>For models:</b>	754595, 754609, 754676, 754681, 754692, 754706, 754749, 757365, 757373, 757381, 757403, 758736, 759201, 759678, 759686, 759694		
<b>accessories for</b>	418739		
	Varenummer Varenummer	551240	Ref. No. 749451
	gasket L 129mm W 87mm D1 ø 12mm D2 ø 7mm 12 holes graphite thickness 1mm		







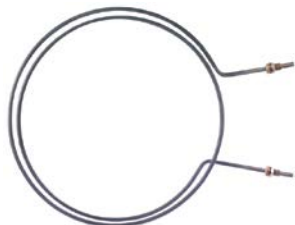

1

Varenummer Varenummer	418959	Ref. No.	742422
<b>description</b>	heating element 21600W 230V heating circuits 6 ID ø 414mm ED ø 466mm L 522mm H 121.5mm L1 88mm W1 97mm H1 30.5mm H2 91mm flange length 130mm flange width 88mm connection M5 connection length 70mm tube ø 6.5mm mounting thread M6 flange with bolt M6		
<b>accessories for</b>	418959		
	Varenummer Varenummer	519647	Ref. No. —
	counterflange ø 8mm perforation ø 13mm L 130mm W 88mm suitable for convection heating element 12 holes		
	Varenummer Varenummer	551240	Ref. No. 749451
	gasket L 129mm W 87mm D1 ø 12mm D2 ø 7mm 12 holes graphite thickness 1mm		







1

Varenummer Varenummer	418766	Ref. No.	101125
<b>description</b>	heating element 4500W 230V heating circuits 1 ID ø 380mm ED ø 405mm L 530mm L1 100mm H 17mm thread M14x1.5 connection M4 tube ø 8.5mm		
<b>For models:</b>	674524, 674532, 674559, 674605, 674680, 674699, 674710, Heissluftdaempfer-10x1-1, Heissluftdaempfer-5x1-1, Heissluftdaempfer-6x1-1, Heissluftdaempfer-Varioplus-20x1-1, Heissluftgeraet-10x1-1, Heissluftgeraet-5x1-1		
<b>spare parts for</b>	418766		
	Varenummer Varenummer	510417	Ref. No. —
	flat gasket fibre ED ø 20mm ID ø 14mm thickness 2mm Qty 1 pcs		
<b>accessories for</b>	418766		
	Varenummer Varenummer	520228	Ref. No. —
	tooth lock washer ID ø 15.3mm ED ø 24mm steel Qty 1 pcs for thread M14		
	Varenummer Varenummer	520230	Ref. No. —
	nut thread M14x1.5 H 5mm WS 19 zinc-coated steel Qty 1 pcs		
	Varenummer Varenummer	521101	Ref. No. —
	nut thread M14x1.5 H 5mm WS 19 SS Qty 1 pcs		
	Varenummer Varenummer	550262	Ref. No. —
	flat gasket copper ED ø 20mm ID ø 14mm thickness 2mm		









1			
Varenummer Varenummer	415805	Ref. No.	693383
<b>description</b>	heating element 5700W 230V heating circuits 3 ID ø 206mm ED ø 245mm L 290mm H 42mm L1 45mm W1 97mm H1 2mm H2 40mm flange length 110mm flange width 20mm hole distance 35mm connection male faston 6.3mm connection length 58mm tube ø 6.3mm convection heating element hole ø 6.5mm rectangular flange		
<b>For models:</b>	671568, 671576, 671584, 671592, 671606, 671614, 671622, 671630, 758752, 758760, 758981, 759007, 759015, 759023, 759031, 759058, 759066, 759074, 759171, 759198		



1			
Varenummer Varenummer	415133	Ref. No.	399329
<b>description</b>	heating element 1430W 230V heating circuits 1 L 85mm W 395mm connection male faston 6.3mm tube ø 6.5mm thread M10x1 2 hole fixing dry heating element mounting distance 389mm		
<b>For models:</b>	390003, 397776, 397784, 397792, 397806, 397814, 397822, 397830, 397849, 397857, 397865, 397873, 399019, 399027, 399035, 399043, 399051, 399078, 399086, 399094, 399108, 399116, 609544, 609552, 609560, 645893, 645907, 645915, 645923, 645931, 645958, 645966, 645974, 645982, 645990, 646024, 646032, 674710, 674788, 674818, HLD-2011		
<b>accessories for</b>	415133		
	Varenummer Varenummer	520231	Ref. No. —
nut thread M10x1 H 6mm WS 14 zinc-coated steel Qty 1 pcs			
	Varenummer Varenummer	521129	Ref. No. —
nut thread M10 H 6mm SS WS 17 Qty 1 pcs DIN/ISO DIN 439			
	Varenummer Varenummer	528433	Ref. No. 097071 217840
flat gasket copper ED ø 14mm ID ø 10mm thickness 1mm			







1			
Varenummer Varenummer	415221	Ref. No.	332429
<b>description</b>	heating element 1430W 230V heating circuits 1 L 90mm W 390mm connection male faston 6.3mm tube ø 6.3mm thread M10x1 2 hole fixing dry heating element mounting distance 376mm		
<b>For models:</b>	674664, 674672, Heissluftdaempfer-10x1-1, Heissluftdaempfer-6x1-1		
<b>spare parts for</b>	415221		
	Varenummer Varenummer	510416	Ref. No. —
flat gasket fibre ED ø 19mm ID ø 10.5mm thickness 1.5mm for thread M10 Qty 1 pcs			
<b>accessories for</b>	415221		
	Varenummer Varenummer	510893	Ref. No. —
O-ring EPDM thickness 2.62mm ID ø 9.92mm Qty 1 pcs			
	Varenummer Varenummer	520231	Ref. No. —
nut thread M10x1 H 6mm WS 14 zinc-coated steel Qty 1 pcs			

<b>accessories for</b>	415221		
	Varenummer Varenummer	521129	Ref. No. —
nut thread M10 H 6mm SS WS 17 Qty 1 pcs DIN/ISO DIN 439			
	Varenummer Varenummer	528433	Ref. No. 097071 217840
flat gasket copper ED ø 14mm ID ø 10mm thickness 1mm			

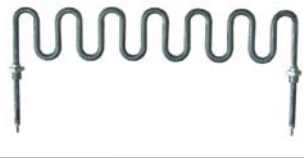

1			
Varenummer Varenummer	418970	Ref. No.	585726
<b>description</b>	heating element 1450W 230V heating circuits 1 L 90mm W 315mm		
<b>For models:</b>	390003, 397229, 397237, 397245, 397253, 397261, 397288, 397296, 397318, 397326, 397334, 397342, 397350, 397776, 397784, 397792, 397806, 397814, 397822, 397830, 397849, 397857, 397865, 397873, 606316, 606324, 606332, 606340, 606359, 606367, 645893, 645907, 645915, 645923, 645931, 645958, 645966, 645974, 645982, 645990, 646024, 646032, 646040, 646059, 646067, 646768, 646776, 646784, 646792, 646806...(Other models you can see in the webshop)		



1			
Varenummer Varenummer	415222	Ref. No.	576581
<b>description</b>	heating element 2300W 230V heating circuits 1 L 90mm W 395mm connection M4 tube ø 8.5mm thread M14x1.5 2 hole fixing dry heating element		
<b>accessories for</b>	415222		
	Varenummer Varenummer	521103	Ref. No. —
nut thread M4 H 3mm WS 7 brass Qty 20 pcs			
	Varenummer Varenummer	521104	Ref. No. —
washer ID ø 4.3mm ED ø 8mm thickness 0.5mm brass Qty 20 pcs for thread M4			
	Varenummer Varenummer	560111	Ref. No. —
plain washer ID ø 4.3mm ED ø 9mm thickness 0.8mm SS Qty 20 pcs DIN 125A for thread M4			
	Varenummer Varenummer	560131	Ref. No. —
hexagonal nut thread M4 H 3.2mm WS 7 SS DIN/ISO DIN 934 / ISO 4032/8673 Qty 20 pcs			

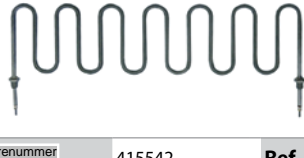





1			
Varenummer Varenummer	415542	Ref. No.	370150
<b>description</b>	heating element 2500W 230V heating circuits 1 L 131mm W 485mm connection length 20mm connection M4 tube ø 8.5mm thread M14x1.5 2 hole fixing convection heating element mounting distance 480mm		
<b>accessories for</b>	415542		
	Varenummer Varenummer	510417	Ref. No. —
flat gasket fibre ED ø 20mm ID ø 14mm thickness 2mm Qty 1 pcs			
	Varenummer Varenummer	520228	Ref. No. —
tooth lock washer ID ø 15.3mm ED ø 24mm steel Qty 1 pcs for thread M14			

Table continues overleaf



accessories for		415542	
	Varenummer Varenummer	520230	Ref. No. —
nut thread M14x1.5 H 5mm WS 19 zinc-coated steel Qty 1 pcs			
	Varenummer Varenummer	521101	Ref. No. —
nut thread M14x1.5 H 5mm WS 19 SS Qty 1 pcs			
	Varenummer Varenummer	550262	Ref. No. —
flat gasket copper ED ø 20mm ID ø 14mm thickness 2mm			



## accessories

### sealing washers

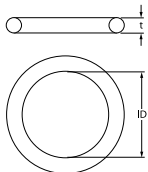
#### O-rings

			
1			
Varenummer Varenummer	510408	Ref. No.	349232
<b>description</b> O-ring EPDM thickness 5.34mm ID ø 47mm Qty 1 pcs			
<b>For models:</b> 665843, 665851, Glaeserspielautomat-325, Glaeserspielautomat-328			

### flange gaskets

			
1			
Varenummer Varenummer	551240	Ref. No.	749451
<b>description</b> gasket L 129mm W 87mm D1 ø 12mm D2 ø 7mm 12 holes graphite thickness 1mm			
<b>accessories for</b> 551240			
	Varenummer Varenummer	519647	Ref. No. —
counterflange ø 8mm perforation ø 13mm L 130mm W 88mm suitable for convection heating element 12 holes			

## energy regulators

### EGO

#### 1-circuit



Varenummer Varenummer	380015	Ref. No.	314544
<b>description</b> energy regulator 230V 13A single-circuit turn direction right shaft ø 6x4.6mm shaft L 23mm mounting thread M4 power release 6-100% no. 50.57021.010			
<b>For models:</b> 503010, 503150, 517887, 574961, 610038, 61030x, 610402, 610429, 620203, 620300, 620408, 620424, 637564, 657735, 659002, 685003, 686018, 686026, 686034, 686298, 688428, 700673, 702560, 706000, FOEM-Kippbratpfanne-Elektro, ODWB-1040-Waermebruecken, ODWB-1240-Waermebruecken, ODWB-1440-Waermebruecken, ODWB-1640-Waermebruecken, ODWB-1840-Waermebruecken, ODWB-2040-Waermebruecken, OEWB-1040-Wand-Waermeborde, OEWB-1240-Wand-Waermeborde, OEWB-1440-Wand-Waermeborde, OEWB-1640-Wand-Waermeborde, OEWB-1840-Wand-Waermeborde, OEWB-2040-Wand-Waermeborde, steakgrill-61030, steakgrill-62030			

## accessories

### knobs



Varenummer Varenummer	110235	Ref. No.	341894
<b>description</b> knob energy regulator 1-3 t.max.°C ø 50mm shaft ø 6x4.6mm shaft flat upper black			
<b>For models:</b> 610038, 610429, 620203, 620424			

# thermostats

## control and safety thermostats

EGO

control thermostats

55.10/19\_series

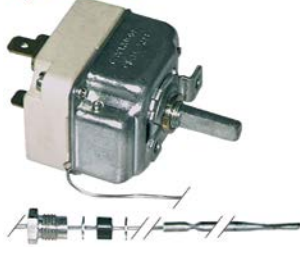

Varenummer Varenummer	375070	<b>Ref. No.</b>	091634
<b>description</b>	thermostat t.max. 250°C temperature range 55-250°C 1-pole 1CO 16A probe ø 3.1mm probe L 226mm capillary pipe 1170mm capillary pipe isolated 1100mm gland nut M9x1 shaft L 23mm shaft position upper rotation 270°		
<b>For models:</b>	140902, 367788, 382191, 385018, 385026, 385034, 385042, 385050, 385514, 389595, 389609, 390003, 397210, 397229, 397237, 397245, 397253, 397261, 397288, 397296, 397318, 397326, 397334, 397342, 397350, 397431, 397776, 397784, 397792, 397806, 397814, 397822, 397830, 397849, 397857, 397865, 397873, 398047, 398055, 398063, 398071, 398098, 398101, 398128, 398136, 398144, 398152, 398950, 398969, 398977...(Other models you can see in the webshop)		

55.13\_series



Varenummer Varenummer	375505	<b>Ref. No.</b>	202029
<b>description</b>	thermostat t.max. 320°C temperature range 50-320°C 1-pole 1NO 16A probe ø 3mm probe L 160mm capillary pipe 870mm capillary pipe isolatedmm gland nut shaft ø 6x4.6mm shaft L 23mm shaft position upper rotation 270°		
<b>For models:</b>	750204, 750212, 750220, 750239, 750336, 750352, 750360		

55.34\_series



Varenummer Varenummer	375143	<b>Ref. No.</b>	290319
<b>description</b>	thermostat t.max. 110°C temperature range 32-110°C 3-pole 3NO 16A probe ø 6mm probe L 138mm capillary pipe 1480mm capillary pipe isolated 1100mm gland nut M9x1 shaft ø 6x4.6mm shaft L 23mm shaft position upper rotation 270°		
<b>For models:</b>	140902, 667412, 684848, 688436, 689335, 689343, 689351, 689378, 718793, Maxima-Elektro-Bain-Marie-700-850, Maxima-Elektro-Bain-Marie-850		



Varenummer Varenummer	375101	<b>Ref. No.</b>	126543
<b>description</b>	thermostat t.max. 360°C temperature range 140-360°C 3-pole 3NO 16A probe ø 4mm probe L 292mm capillary pipe 990mm capillary pipe isolated 500mm gland nut shaft L 23mm shaft position upper rotation 318°		
<b>For models:</b>	Pizza-Ofen-ELP		

## safety thermostats

55.11\_series



Varenummer Varenummer	375093	<b>Ref. No.</b>	242746
<b>description</b>	safety thermostat switch-off temp. 318°C 1-pole 12A probe ø 4mm probe L 111mm capillary pipe 530mm capillary pipe isolated 450mm gland nut M9x1 probe SS		

55.32\_series

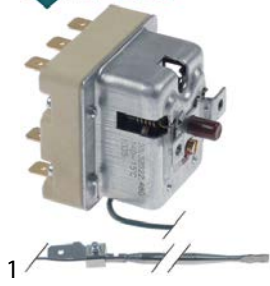

Varenummer Varenummer	390921	Ref. No.	572705
<b>description</b>	safety thermostat switch-off temp. 305°C 3-pole 3NC 20A probe ø 4mm probe L 128mm capillary pipe 890mm capillary pipe isolated 800mm gland nut probe		

55.33\_series



Varenummer Varenummer	375075	Ref. No.	384429
<b>description</b>	safety thermostat switch-off temp. 305°C 3-pole probe		



Varenummer Varenummer	375118	Ref. No.	580457
<b>description</b>	safety thermostat switch-off temp. 360°C 3-pole 20A probe ø 15mm probe L 8mm capillary pipe 1150mm capillary pipe isolated 1100mm gland nut probe with knob probe		
<b>For models:</b>	671568, 671576, 671584, 671592, 671606, 671614, 671622, 671630, 671649, 671657, 671665, 671673, 671681, 671711, 671746, 671754, 671762, 671770, 671789, 671797, 671800, 671819, 671827, 671835, 671843, 671851, 671878, 671886, 671894, 671908, 671916, 671975, 671983, 671991, 680583, 680591		

56.\_series

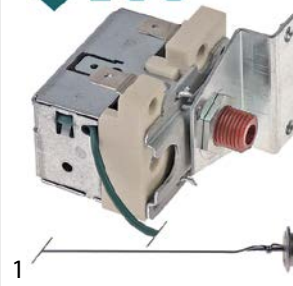

Varenummer Varenummer	375889	Ref. No.	504602
<b>description</b>	safety thermostat switch-off temp. 360°C 1-pole 16A probe ø 15mm probe L 6.5mm capillary pipe 1140mm capillary pipe isolated 1100mm gland nut probe		

**For models:**  
671568, 671576, 671584, 671592, 671606, 671614, 671622, 671630, 754595, 754609, 754617, 754668, 754676, 754681, 754692, 754706, 754714, 754722, 754730, 754749, 754757, 754773, 754781, 757292, 757314, 757365, 757373, 757381, 757403, 757411, 757438, 757446, 757454, 757462, 757470, 758736, 758752, 758760, 758833, 758981, 759007, 759015, 759023, 759031, 759058, 759066, 759074, 759171, 759198, 759201...(Other models you can see in the webshop)

<b>accessories for</b>	375889		
Varenummer Varenummer	518669	Ref. No.	373079
<b>description</b>	gasket PTFE ED ø 21mm ID ø 15mm thickness 3.5mm		

accessories



Varenummer Varenummer	518669	Ref. No.	373079
<b>description</b>	gasket PTFE ED ø 21mm ID ø 15mm thickness 3.5mm		
<b>accessories for</b>	518669		
Varenummer Varenummer	375889	Ref. No.	504602
<b>description</b>	safety thermostat switch-off temp. 360°C 1-pole 16A probe ø 15mm probe L 6.5mm capillary pipe 1140mm capillary pipe isolated 1100mm gland nut probe		

control thermostats with operation switch

55.34\_series

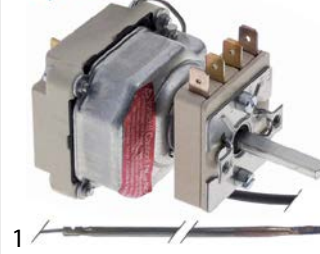

Varenummer Varenummer	375140	Ref. No.	661635
<b>description</b>	thermostat t.max. 650°C temperature range 50°C/50-600°C/70-650°C 3-pole 3NO 16A probe ø 4mm probe L 228mm capillary pipe 1200mm capillary pipe isolated 1200mm gland nut shaft ø 6x4.6mm shaft L 23mm shaft position left rotation 318° nut switch 2NO		
<b>For models:</b>	663263, 663395, 670618, 670626, 688096, 688118, 703117, 703125, 709832, 709840, 733105, 733113, 736422, 736430		



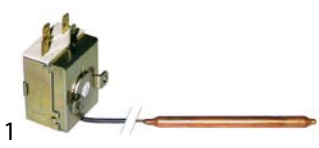

IMIT / TEMPOMATIC / ARATHERMO

control thermostats

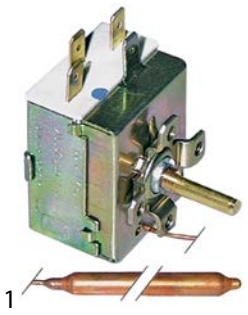

Varenummer Varenummer	390186	Ref. No.	208442
description	thermostat t.max. 52°C temperature range fixed 52°C 1-pole 1CO 16A probe ø 6.5mm probe L 95mm capillary pipe 1000mm capillary pipe isolated 1000mm gland nut shaft Lmm contacts 1CO		
For models:	Glaeserspielautomat-310, Glaeserspielautomat-311, Glaeserspielautomat-320, Glaeserspielautomat-321		



Varenummer Varenummer	390006	Ref. No.	208418
description	thermostat t.max. 86°C temperature range 0-86°C 1-pole 1CO 16A probe ø 6.5mm probe L 95mm capillary pipe 1500mm capillary pipe isolatedmm gland nut shaft ø 6x4.6mm shaft L 19mm rotation 270°		
For models:	Glaeserspielautomat-310, Glaeserspielautomat-311, Glaeserspielautomat-320, Glaeserspielautomat-321		
accessories for	390006		
		Varenummer Varenummer	110100 Ref. No. —
	knob thermostat t.max. 90°C 0-90°C ø 42mm shaft ø 6x4.6mm shaft flat -135° black		
		Varenummer Varenummer	110105 Ref. No. —
	rosette knob ø 42mm ø 56mm zero mark		

control thermostats with actual value



Varenummer Varenummer	379034	Ref. No.	368814
description	thermostat t.max. 450°C temperature range 50-450°C 1-pole 1CO 5A probe ø 6mm probe L 30mm capillary pipe 1150mm capillary pipe isolatedmm gland nut mounting ø 80mm mounting measurements 96x96mm		
For models:	Pizza-Ofen-P501, Pizza-Ofen-P502		

accessories

connecting bows





Varenummer Varenummer	550059	Ref. No.	086223
description	connecting bow short for switch Qty 1 pcs		

switches and momentary switches

rocker/momentary rocker switches

30x22mm



Varenummer Varenummer	301003	Ref. No.	053295
description	rocker switch mounting measurements 30x22mm green 2NO 250V 16A illuminated 0-I connection male faston 6.3mm ambient temperature max. 125/55°C protection IP65		
For models:	271500, 643807, 707007, 805556, 825263, Geschirrspielautomat-330, GsP-350, GsP-500, schokomat-C		
accessories for	301003		
		Varenummer Varenummer	301036 Ref. No. —
	protective cover internal size 30x22mm for rocker switch mounting measurementsmm		

push/momentary push switches

30x22mm



Varenummer Varenummer	345863	Ref. No.	336912
description	momentary push switch mounting measurements 30x22mm clear 1NO/1NC 250V 16A illuminated connection male faston 4.8mm/6.3mm ambient temperature max. 85°C protection IP40		
For models:	361763, 367788, 378933, 382191, 385018, 385026, 385034, 385042, 385050, 385514, 397210, 397431, 440078, 440086, 440094, 440140, 440655, 450111, 606294		

1

Varenummer Varenummer	301040 <sup>1</sup>	Ref. No.	266108 336904
<b>description</b>	push switch mounting measurements 30x22mm green 2NO 250V 16A illuminated connection male faston 6.3mm ambient temperature max. 85°C protection IP40		
<b>For models:</b>	340022, 340030, 340049, 340057, 340073, 353167, 354392, 354457, 361763, 378933, 440078, 440086, 440094, 440140, 440655, 450111, 643807, 668001, 669008, 707007, 825263, Glaeserspielautomat-325, Glaeserspielautomat-328, ODWB-1040-Waermebruecken, ODWB-1240-Waermebruecken, ODWB-1440-Waermebruecken, ODWB-1640-Waermebruecken, ODWB-1840-Waermebruecken, ODWB-2040-Waermebruecken, OEWB-1040-Wand-Waermeborde, OEWB-1240-Wand-Waermeborde, OEWB-1440-Wand-Waermeborde, OEWB-1640-Wand-Waermeborde, OEWB-1840-Wand-Waermeborde, OEWB-2040-Wand-Waermeborde, OEWS1245-einseitig-400x1200mm, OEWS1246-einseitig-mit-Rueckwandverkleidung, UDWE1225L, UDWE1225L-doppelseitig-Eck-640x1200mm, UDWE1225R, UDWE1225R-doppelseitig-Eck-640x1200mm, UDWF0825, UDWF0825D-doppelseitig-640x800mm, UDWs1225, UDWs1225-doppelseitig-640x1200mm, UEFW0825, UEFW0825D-einseitig-640x800mm, UEWS06-schubladeblock-640x600mm, UEWS1225, UEWS1225-doppelseitig-640x1200mm...(Other models you can see in the webshop)		

<sup>1</sup>illuminated

microswitches

universal



1

Varenummer Varenummer	345042	Ref. No.	570540
<b>description</b>	microswitch with plunger 250V 16A 1CO connection male faston 6.3mm L 28mm ambient temperature max. 125°C mounting distance 22mm type EF83161.3 actuating force: 75g blue/black		
<b>accessories for</b>	345042		
	Varenummer Varenummer	345043	Ref. No. —
	lever set 5-piece		

lever actuated



1

Varenummer Varenummer	345773	Ref. No.	144894 680907
<b>description</b>	microswitch with lever 250V 16A 1CO connection male faston 6.3mm L 60mm ambient temperature max. 125°C mounting distance 22mm actuating force: 65g lever length 51mm		
<b>For models:</b>	144819, 502200, 502308, 503010, 503150, 515892, 515906, 516678, 517887, 601004, 601209, 601403, 602000, 602205, 602280, 603007, 603023, 603201, 637564, 639087, 649554, 649562, 650943, 650951, 657735, 686298, 686336, 688339, 688347, 688355, 688428, 689696, 699047, 699055, 699063, 700673, 702560, 721468, 722588, 750255, Fritteuse-365, Fritteuse-600, Fritteuse-601, Fritteuse-602, Fritteuse-603, schokomat-C, Topline-Friteuse, Vario-Braeter-plus, Vario-Griller		

pin-plunger actuated



1

Varenummer Varenummer	345042	Ref. No.	570540
<b>description</b>	microswitch with plunger 250V 16A 1CO connection male faston 6.3mm L 28mm ambient temperature max. 125°C mounting distance 22mm type EF83161.3 actuating force: 75g blue/black		
<b>accessories for</b>	345042		
	Varenummer Varenummer	345043	Ref. No. —
	lever set 5-piece		

M10



1

Varenummer Varenummer	345032	Ref. No.	208477
<b>description</b>	microswitch with plunger thread M10x1 thread L 12mm 250V 16A 1CO connection male faston 6.3mm stroke 7mm mounting distance 22mm L 28mm ambient temperature max. 125°C type SP9603 actuating force: 180g		
<b>For models:</b>	Glaeserspielautomat-310, Glaeserspielautomat-311, Glaeserspielautomat-320, Glaeserspielautomat-321		

M16



1

Varenummer Varenummer	345046	Ref. No.	092444
<b>description</b>	microswitch with plunger thread M16x1 thread L 25mm 250V 5A 1NC/1NO connection male faston 6.3mm stroke 6mm ambient temperature max. 85°C actuating force: 400g		
<b>For models:</b>	389595, 389609, 398950, 398969, 398977, 609188, 609196, 637599, 674524, 674532, 674605, 674648, 674656, 674664, 674672, 674680, 674699, 674885, Heissluftdaempfer-10x1-1, Heissluftdaempfer-5x1-1, Heissluftdaempfer-5x2-3, Heissluftdaempfer-6x1-1, Heissluftgeraet-5x1-1, Heissluftgeraet-5x2-3		

accessories



1



Varenummer Varenummer	347013	Ref. No.	587141
<b>description</b>	lever for microswitch		
<b>For models:</b>	671568, 671576, 671584, 671592, 671606, 671614, 671622, 671630, 758752, 758760, 758981, 759007, 759015, 759023, 759031, 759058, 759066, 759074, 759171, 759198		

cam switches

on/off



1

Varenummer Varenummer	300020	Ref. No.	291757
description	cam switch 4 operating positions 2NO sequence 0-1-0-1 16A shaft $\varnothing$ 6x4.6mm shaft L 23mm connection screw ceramic		
For models:	Maxima-Elektro-Kippbratpfanne-700-850, Maxima-Gas-Kippbratpfanne-neue-Ausfuehrung-700-850		
accessories for	300020		
	Varenummer Varenummer	110135	Ref. No. —
	rosette knob up to $\varnothing$ 52mm		
	Varenummer Varenummer	110231	Ref. No. —
	knob switch 0-1-0-1 t.max.°C°C $\varnothing$ 50mm shaft $\varnothing$ 6x4.6mm shaft flat upper black		

4-position

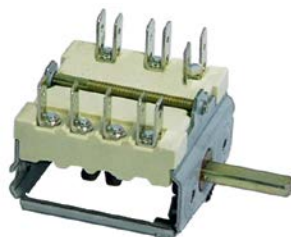

1

Varenummer Varenummer	300016	Ref. No.	104248
description	cam switch 4 operating positions 1NO/2CO sequence 0-1-2-3 16A shaft $\varnothing$ 6x4.6mm shaft L 23mm connection male faston 6.3mm ceramic		
For models:	685003, Grill-681		



1

Varenummer Varenummer	300103	Ref. No.	226491
description	cam switch 4 operating positions 1NO/2CO sequence 0-1-2-3 32A shaft $\varnothing$ 6x4.6mm shaft L 23mm connection screw ceramic		
For models:	541869, 638625, 730416, FOEM-Elektro-Kochplatten		



1

Varenummer Varenummer	300104	Ref. No.	126608
description	cam switch 4 operating positions 3NO/1CO sequence 0-1-2-3 32A shaft $\varnothing$ 6x4.6mm shaft L 23mm connection screw ceramic		
For models:	Grill-682, Grill-683		

4 operating positions

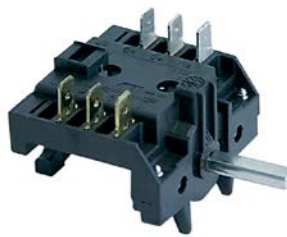

1

Varenummer Varenummer	300033	Ref. No.	103680 370983
description	cam switch 4 operating positions 4NO sequence 0-1-2-3 16A shaft $\varnothing$ 6x4.6mm shaft L 23mm connection male faston 6.3mm plastic		
For models:	Heisse-Theke-HT-50-85-und-120-3		



1

Varenummer Varenummer	300057	Ref. No.	292664
description	cam switch 4 operating positions 6NO sequence 0-1-2-3 16A shaft $\varnothing$ 6x4.6mm shaft L 23mm connection male faston 6.3mm 6CH/141 plastic		
For models:	Heissluftdaempfer-10x1-1, Heissluftdaempfer-5x1-1, Heissluftdaempfer-5x2-3		

5 operating positions



1

Varenummer Varenummer	345199	Ref. No.	720534
description	cam switch 5 operating positions 2NO/1CO sequence 0-1-2-3-4 16A shaft $\varnothing$ 6x4.6mm shaft L 23mm connection male faston 6.3mm		
For models:	354716, 354724		



## magnetic switches

M12x1

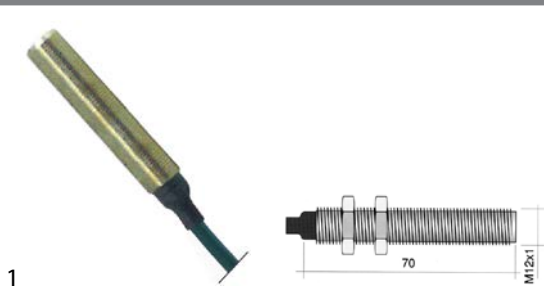

Varenummer Varenummer	345135	Ref. No.	372986
<b>description</b>	magnetic switch thread M12x1 1NO 250V 3A P max. 100W connection cable length 2000mm L 72mm type 122		

## switch blocks



Varenummer Varenummer	359756	Ref. No.	580384
<b>description</b>	contact block latching 1NO/1NC connection male faston 2.8mm illuminable socket T5.5K type BFL5		
<b>For models:</b>	671568, 671576, 671584, 671592, 671606, 671614, 671622, 671630, 671649, 671657, 671665, 671673, 671681, 671711, 671746, 671754, 671789, 671797, 671800, 671819, 671827, 671835, 671843, 671851		
<b>accessories for</b>	359756		
	Varenummer Varenummer	359593	Ref. No. 323519
	light bulb socket T5.5K 60V 0.02A		

## control equipment

SCHLEGEL

## push buttons



Varenummer Varenummer	359183	Ref. No.	323527 332712
<b>description</b>	momentary switch unit mounting measurements ø16/24x24mm type momentary anthracite/transparent square		
<b>For models:</b>	Heissluftdaempfer-10x1-1, Heissluftdaempfer-20x1-1, Heissluftdaempfer-5x1-1, Heissluftdaempfer-5x2-3, Heissluftgeraet-672, Heissluftgeraet-673		



Varenummer Varenummer	346188	Ref. No.	580341
<b>description</b>	momentary switch unit mounting measurements ø16/24x24mm type momentary black/white square		
<b>For models:</b>	671568, 671576, 671584, 671592, 671606, 671614, 671622, 671630, 671649, 671657, 671665, 671673, 671681, 671711, 671746, 671754, 671789, 671797, 671800, 671819, 671827, 671835, 671843, 671851		

## symbol plates



Varenummer Varenummer	359757	Ref. No.	580368
<b>description</b>	symbol plate octagonal white ON-OFF		



Varenummer Varenummer	359184	Ref. No.	323535
<b>description</b>	contact block momentary 1NC/1NO connection male faston 2.8mm socket type AT		
<b>For models:</b>	389595, 389609, 398950, 398969, 398977, 609188, 609196, 637599, 674648, 674656, 674664, 674680, 674885, Heissluftdaempfer-10x1-1, Heissluftdaempfer-20x1-1, Heissluftdaempfer-5x1-1, Heissluftdaempfer-5x2-3, Heissluftdaempfer-6x1-1, Heissluftdaempfer-Varioplus-20x1-1, Heissluftdaempfer-Varioplus-20x2-1, Heissluftgeraet-672, Heissluftgeraet-673		

## accessories



Varenummer Varenummer	359768	Ref. No.	580376
<b>description</b>	cap for momentary switch transparent/colourless octagonal L 19.4mm W 19.4mm		

## lamps



Varenummer Varenummer	359606	Ref. No.	1G887026
<b>description</b>	neon light bulb socket Ba9s 230V 2W clear ø 10mm L 28mm		
<b>accessories for</b>	359606		
	Varenummer Varenummer	359832	Ref. No. —
	lamp socket mounting measurements ø16.2mm socket Ba9s connection male faston 6.3mm		
	Varenummer Varenummer	359853	Ref. No. —
	lamp socket mounting measurements ø18.2mm socket Ba9s connection male faston 6.3mm		



# lamps

## indicator lights

### indicator lights 3-piece (housing, lens and bulb)

#### lamps

#### neon light bulbs

 <p>1</p>			
Varenummer Varenummer	359606	Ref. No.	1G887026
description	neon light bulb socket Ba9s 230V 2W clear ø 10mm L 28mm		
accessories for	359606		
	Varenummer Varenummer	359832	Ref. No. —
	lamp socket mounting measurements ø16.2mm socket Ba9s connection male faston 6.3mm		
	Varenummer Varenummer	359853	Ref. No. —
	lamp socket mounting measurements ø18.2mm socket Ba9s connection male faston 6.3mm		

 <p>1</p>			
Varenummer Varenummer	359600	Ref. No.	035378
description	neon light bulb socket E10 220V 0.35W clear ø 10mm L 28mm		
For models:	685003, 686018, Grill-680, Grill-681, Grill-682, Grill-683, Heissluftgeraet-10x1-1, Heissluftgeraet-5x1-1, Heissluftgeraet-5x2-3, Heissluftgeraet-672, Heissluftgeraet-673, Heissluftgeraet-67310, Wandkaffeemaschine-001		
accessories for	359600		
	Varenummer Varenummer	359060	Ref. No. 101818
	lamp socket mounting measurements ø16.2mm socket E10 connection screw		
	Varenummer Varenummer	359063	Ref. No. —
	lamp socket mounting measurements ø19.2mm socket E14 connection screw		
	Varenummer Varenummer	359064	Ref. No. —
	lamp socket mounting measurements ø22.3mm socket E14 connection screw 250/380V ambient temperature at 1W 100°C ambient temperature at 2W 85°C		
	Varenummer Varenummer	359685	Ref. No. —
	lamp socket mounting measurements ø16.2mm socket E10		
	Varenummer Varenummer	359832	Ref. No. —
	lamp socket mounting measurements ø16.2mm socket Ba9s connection male faston 6.3mm		
	Varenummer Varenummer	359853	Ref. No. —
	lamp socket mounting measurements ø18.2mm socket Ba9s connection male faston 6.3mm		
	Varenummer Varenummer	359988	Ref. No. —
	lamp socket mounting measurements ø30.5mm 250V connection F6.3 temp.-resist. 55°C E14		

 <p>1</p>			
Varenummer Varenummer	359602	Ref. No.	006718
description	neon light bulb socket E14 230V clear ø 14mm L 30mm		
For models:	721468, 721476, 721484, 722588, 722596, 722618, Maxima-Elektro-Backofen-700-850, Maxima-Elektro-Backofen-850, Maxima-Elektro-Bain-Marie-700-850, Maxima-Elektro-Bain-Marie-850, Maxima-Elektro-Herd-700-850, Maxima-Elektro-Herd-850, Maxima-Elektro-Kippbratpfanne-700-850		

### indicator lights (complete)

#### ø 6mm

 <p>1</p>			
Varenummer Varenummer	359004	Ref. No.	332771
description	indicator light ø 6mm 230V green cable length 400mm temp.-resist. 106°C		

 <p>1</p>			
Varenummer Varenummer	359005	Ref. No.	332798
description	indicator light ø 6mm 230V yellow cable length 400mm		

#### ø10mm

#### with plug-in socket

 <p>1</p>			
Varenummer Varenummer	359230	Ref. No.	370991
description	indicator light ø 10mm green 230V connection male faston 2.8mm Qty 1 pcs		
For models:	Heisse-Theke-HT-50-85-und-120-3		

 <p>1</p>			
Varenummer Varenummer	359140	Ref. No.	091462 091642
description	indicator light ø 10mm yellow 230V connection male faston 6.3mm Qty 1 pcs		

#### 30x22mm

 <p>1</p>			
Varenummer Varenummer	359156	Ref. No.	053317
description	indicator light mounting measurements 30x22mm 230V yellow connection male faston 6.3mm temp.-resist. 125/55°C type RL2		
For models:	271500, 805556, Geschirrspuelautomat-330, GsP-350, GsP-500		



## miscellaneous



1

Varenummer Varenummer	359429	Ref. No.	395056
<b>description</b>	indicator light 230V connection male faston 6.3mm mounting ø 18mm		
<b>For models:</b>	140902, 354643, 354651, 354678, 354686, 354694, 354708, 502200, 502308, 502650, 502707, 503010, 503150, 505900, 505935, 515892, 515906, 517887, 541869, 627984, 628018, 628026, 637564, 638625, 649554, 649562, 650129, 650137, 650145, 650153, 650943, 650951, 657735, 659002, 663263, 663395, 667412, 670618, 670626, 684848, 686247, 686298, 686328, 686336, 686409, 687200, 687960, 688096, 688118, 688290...(Other models you can see in the webshop)		

## screw-on/push-on fit

## neon light bulbs



1

Varenummer Varenummer	359606	Ref. No.	1G887026	
<b>description</b>	neon light bulb socket Ba9s 230V 2W clear ø 10mm L 28mm			
<b>accessories for</b>	359606			
	Varenummer Varenummer	359832	Ref. No.	—
	lamp socket mounting measurements ø16.2mm socket Ba9s connection male faston 6.3mm			
	Varenummer Varenummer	359853	Ref. No.	—
	lamp socket mounting measurements ø18.2mm socket Ba9s connection male faston 6.3mm			



1

Varenummer Varenummer	359600	Ref. No.	035378	
<b>description</b>	neon light bulb socket E10 220V 0.35W clear ø 10mm L 28mm			
<b>For models:</b>	685003, 686018, Grill-680, Grill-681, Grill-682, Grill-683, Heissluftgeraet-10x1-1, Heissluftgeraet-5x1-1, Heissluftgeraet-5x2-3, Heissluftgeraet-672, Heissluftgeraet-673, Heissluftgeraet-67310, Wandkaffeemaschine-001			
<b>accessories for</b>	359600			
	Varenummer Varenummer	359060	Ref. No.	101818
	lamp socket mounting measurements ø16.2mm socket E10 connection screw			
	Varenummer Varenummer	359063	Ref. No.	—
	lamp socket mounting measurements ø19.2mm socket E14 connection screw			
	Varenummer Varenummer	359064	Ref. No.	—
	lamp socket mounting measurements ø22.3mm socket E14 connection screw 250/380V ambient temperature at 1W 100°C ambient temperature at 2W 85°C			
	Varenummer Varenummer	359685	Ref. No.	—
	lamp socket mounting measurements ø16.2mm socket E10			
	Varenummer Varenummer	359832	Ref. No.	—
	lamp socket mounting measurements ø16.2mm socket Ba9s connection male faston 6.3mm			
	Varenummer Varenummer	359853	Ref. No.	—
	lamp socket mounting measurements ø18.2mm socket Ba9s connection male faston 6.3mm			

<b>accessories for</b>	359600			
	Varenummer Varenummer	359988	Ref. No.	—
	lamp socket mounting measurements ø30.5mm 250V connection F6.3 temp.-resist. 55°C E14			

	1		
Varenummer Varenummer	359602	Ref. No.	006718
<b>description</b>	neon light bulb socket E14 230V clear ø 14mm L 30mm		
<b>For models:</b>	721468, 721476, 721484, 722588, 722596, 722618, Maxima-Elektro-Backofen-700-850, Maxima-Elektro-Backofen-850, Maxima-Elektro-Bain-Marie-700-850, Maxima-Elektro-Bain-Marie-850, Maxima-Elektro-Herd-700-850, Maxima-Elektro-Herd-850, Maxima-Elektro-Kippbratpfanne-700-850		

## light bulbs

## for ovens



1

Varenummer Varenummer	359610	Ref. No.	047635
<b>description</b>	light bulb t.max. 300°C socket E14 15W 230V ø 22mm L 47mm lens L 20mm for oven lamp type Philips		
<b>For models:</b>	685003, 805xxx, 890502, 890510, 890529, 890553, 890561, 890588, 890596, 890618, 890626, Aromacarina, Aromacarina-Dampf, Aromacarina-EsA, Aromacarina-ETA, Aromacarina-ETA-EsA, Heissluftdaempfer-10x1-1, Heissluftdaempfer-20x1-1, Heissluftdaempfer-5x1-1, Heissluftdaempfer-5x2-3, Heissluftgeraet-10x1-1, Heissluftgeraet-5x1-1, Heissluftgeraet-5x2-3, Heissluftgeraet-672, Heissluftgeraet-673, Heissluftgeraet-67310		



1

Varenummer Varenummer	359612	Ref. No.	354252
<b>description</b>	light bulb t.max. 300°C socket E14 25W 230V ø 25mm L 56mm lens L 30mm for oven lamp type Philips		
<b>For models:</b>	367788, 382191, 385018, 385026, 385034, 385042, 385050, 385514, 389595, 389609, 390003, 397210, 397229, 397237, 397245, 397253, 397261, 397288, 397296, 397318, 397326, 397334, 397342, 397350, 397431, 397776, 397784, 397792, 397806, 397814, 397822, 397830, 397849, 397857, 397865, 397873, 398047, 398055, 398063, 398071, 398098, 398101, 398128, 398136, 398144, 398152, 398950, 398969, 398977, 399019...(Other models you can see in the webshop)		

## halogen lamp

## for socket G4 / G6.35 / G9



1

Varenummer Varenummer	359599	Ref. No.	570478
<b>description</b>	halogen lamp socket G4 12V 20W temp.-resist. 500°C		

linear lamps

infrared lamps

with base type R7s



Varenummer Varenummer	359628	Ref. No.	164941
<b>description</b>	infrared lamp socket R7s L 117.6mm 240V 300W IMPORT unjacketed		
<b>For models:</b>	Heisse-Theke-HT-50-85-und-120-3		

with base type X lug



Varenummer Varenummer	359617	Ref. No.	104566 531332
<b>description</b>	infrared lamp 1000W 220V L 365mm lens L 340mm total length 480mm with mounting strap		
<b>For models:</b>	Grill-681, Grill-682, Grill-683		

sockets for linear lamps

X lug



Varenummer Varenummer	359710	Ref. No.	104574
<b>description</b>	lamp socket L 70mm W 70mm H 49mm mounting distance 50mm bracket mounting		
<b>For models:</b>	Grill-681, Grill-682, Grill-683		



oven lamps

universal oven lamps

mounting diameter 35.5mm



Varenummer Varenummer	359701	Ref. No.	100838
<b>description</b>	lamp socket socket E14 220-230V mounting ø 35.5mm connection male faston 6.3mm 15W		
<b>For models:</b>	398047, 398055, 398063, 398071, 398098, 398101, 398128, 398136, 398144, 398152, 609501, 609528, 609536, 674559, 674648, 674656, 674664, 674672, 674680, 674699, 674834, 674893, 685003, Heissluftdaempfer-10x1-1, Heissluftdaempfer-20x1-1, Heissluftdaempfer-5x1-1, Heissluftdaempfer-5x2-3, Heissluftdaempfer-6x1-1, Heissluftgeraet-10x1-1, Heissluftgeraet-5x1-1, Heissluftgeraet-5x2-3, Heissluftgeraet-672, Heissluftgeraet-673, Heissluftgeraet-67310		
<b>accessories for</b>	359701		
	Varenummer Varenummer	359705	Ref. No. 092339
	oven lamp glass thr.ø 33.5mm ø 52mm hard glas temp.-resist. 350°C		

<b>accessories for</b>	359701		
	Varenummer Varenummer	359709	Ref. No. —
	oven lamp glass thr.ø 33.5mm ø 42mm hard glas temp.-resist. 350°C		
	Varenummer Varenummer	359721	Ref. No. 316296 693421
	gasket silicone ED ø 48mm ID ø 39.5mm thickness 5mm Qty 1 pcs		
	Varenummer Varenummer	359942	Ref. No. —
	oven lamp glass thr.ø 33.5mm ø 41mm hard glas temp.-resist. 350°C		

	Varenummer Varenummer	359705	Ref. No. 092339
<b>description</b>	oven lamp glass thr.ø 33.5mm ø 52mm hard glas temp.-resist. 350°C		
<b>For models:</b>	671568, 671576, 671584, 671592, 671606, 671614, 671622, 671630, 758752, 758760, 758981, 759007, 759015, 759023, 759031, 759058, 759066, 759074, 759171, 759198, Heissluftdaempfer-10x1-1, Heissluftdaempfer-20x1-1, Heissluftdaempfer-5x1-1, Heissluftdaempfer-5x2-3		
<b>accessories for</b>	359705		
	Varenummer Varenummer	359610	Ref. No. 047635
	light bulb t.max. 300°C socket E14 15W 230V ø 22mm L 47mm lens L 20mm for oven lamp type Philips		
	Varenummer Varenummer	359700	Ref. No. —
	gasket for pizza oven fibre glass ID ø 32.5mm ED ø 55mm thickness 5mm		
	Varenummer Varenummer	359721	Ref. No. 316296 693421
	gasket silicone ED ø 48mm ID ø 39.5mm thickness 5mm Qty 1 pcs		
	Varenummer Varenummer	359837	Ref. No. —
	gasket ID ø 33mm ED ø 46mm thickness 1mm graphite		
	Varenummer Varenummer	359838	Ref. No. —
	gasket ID ø 33mm ED ø 45mm		

	Varenummer Varenummer	359721	Ref. No. 316296 693421
<b>description</b>	gasket silicone ED ø 48mm ID ø 39.5mm thickness 5mm Qty 1 pcs		
<b>For models:</b>	Heissluftdaempfer-10x1-1, Heissluftdaempfer-5x1-1, Heissluftdaempfer-5x2-3		



## producer-specific oven lamps

## PALUX



1

Varenummer Varenummer	359068	Ref. No.	314019
<b>description</b>	lamp socket with 2 hole fixing socket E14 ø 25mm		

## lamps

## light bulbs



1

Varenummer Varenummer	359610	Ref. No.	047635
<b>description</b>	light bulb t.max. 300°C socket E14 15W 230V ø 22mm L 47mm lens L 20mm for oven lamp type Philips		
<b>For models:</b>	685003, 805xxx, 890502, 890510, 890529, 890553, 890561, 890588, 890596, 890618, 890626, Aromacarina, Aromacarina-Dampf, Aromacarina-EsA, Aromacarina-ETA, Aromacarina-ETA-EsA, Heissluftdaempfer-10x1-1, Heissluftdaempfer-20x1-1, Heissluftdaempfer-5x1-1, Heissluftdaempfer-5x2-3, Heissluftgeraet-10x1-1, Heissluftgeraet-5x1-1, Heissluftgeraet-5x2-3, Heissluftgeraet-672, Heissluftgeraet-673, Heissluftgeraet-67310		



1

Varenummer Varenummer	359612	Ref. No.	354252
<b>description</b>	light bulb t.max. 300°C socket E14 25W 230V ø 25mm L 56mm lens L 30mm for oven lamp type Philips		
<b>For models:</b>	367788, 382191, 385018, 385026, 385034, 385042, 385050, 385514, 389595, 389609, 390003, 397210, 397229, 397237, 397245, 397253, 397261, 397288, 397296, 397318, 397326, 397334, 397342, 397350, 397431, 397776, 397784, 397792, 397806, 397814, 397822, 397830, 397849, 397857, 397865, 397873, 398047, 398055, 398063, 398071, 398098, 398101, 398128, 398136, 398144, 398152, 398950, 398969, 398977, 399019...(Other models you can see in the webshop)		

## halogen lamps

## for socket G4 / G6.35 / G9



1

Varenummer Varenummer	359599	Ref. No.	570478
<b>description</b>	halogen lamp socket G4 12V 20W temp.-resist. 500°C		

## sockets

## G4 / G5,3 / G6,35



1

Varenummer Varenummer	359646	Ref. No.	577294
<b>description</b>	lamp socket socket G4/G5.3/G6.35 24V ø 17mm H 15mm connection cable 130mm mounting distance 26mm for halogen lamp holder length 31mm cable length 130mm		
<b>For models:</b>	671568, 671576, 671584, 671592, 671606, 671614, 671622, 671630, 671649, 671657, 671665, 671673, 671681, 671711, 671746, 671754, 671762, 671770, 671789, 671797, 671800, 671819, 671827, 671835, 671843, 671851, 671878, 671886, 671894, 671908, 671916, 671975, 671983, 671991, 680583, 680591, 758752, 758760, 758981, 759007, 759015, 759023, 759031, 759058, 759066, 759074, 759171, 759198		

## residual heat indicators



1

Varenummer Varenummer	359429	Ref. No.	395056
<b>description</b>	indicator light 230V connection male faston 6.3mm mounting ø 18mm		
<b>For models:</b>	140902, 354643, 354651, 354678, 354686, 354694, 354708, 502200, 502308, 502650, 502707, 503010, 503150, 505900, 505935, 515892, 515906, 517887, 541869, 627984, 628018, 628026, 637564, 638625, 649554, 649562, 650129, 650137, 650145, 650153, 650943, 650951, 657735, 659002, 663263, 663395, 667412, 670618, 670626, 684848, 686247, 686298, 686328, 686336, 686409, 687200, 687960, 688096, 688118, 688290...(Other models you can see in the webshop)		

## timers

## electric timers





1

Varenummer Varenummer	350001	Ref. No.	157988
<b>description</b>	timer 2CO at 250V 16A permanent position yes impulse electric shaft ø 6x4.6mm shaft L 22mm mounting distance 28mm connection rear 2-pole operation time 120min		
<b>For models:</b>	389595, 389609, 398950, 398969, 398977, 609188, 609196, 637599, 674524, 674532, 674605, 674648, 674656, 674664, 674680, 674885, Heissluftdaempfer-10x1-1, Heissluftdaempfer-20x1-1, Heissluftdaempfer-5x1-1, Heissluftdaempfer-5x2-3, Heissluftdaempfer-6x1-1, Heissluftdaempfer-Varioplus-20x1-1, Heissluftdaempfer-Varioplus-20x2-1, Heissluftgeraet-10x1-1, Heissluftgeraet-5x1-1, Heissluftgeraet-5x2-3		

1

Varenummer Varenummer	350059	<b>Ref. No.</b>	871400
<b>description</b>	timer MS65 operation time 120min time spreadmin 2CO/1NO at 250V 16A permanent position yes impulse electric shaft ø 6x4.6mm shaft L 20mm mounting distance 28mm mounting thread M4 connection lateral 3-pole		
<b>accessories for</b>	350059		
	Varenummer Varenummer	110366	Ref. No. —
	knob switch zero mark t.max.°C ø 44mm shaft ø 6x4.6mm shaft flat upper black		
	Varenummer Varenummer	110381	Ref. No. —
	dial plate graduation 120min permanent position yes rotation 0-300° ø 60mm timers knob ø 45mm with permanent position		

audible timers



1

Varenummer Varenummer	350014	<b>Ref. No.</b>	018511 720585 836117
<b>description</b>	audible timer operation time 15min ø 56mm shaft ø 6x4.6mm shaft L 24mm mounting distance 28mm		
<b>For models:</b>	354716, 354724, 502200, 502308, 600008, 600067, 601004, 601209, 601403, 602000, 602205, 602280, 603007, 603023, 603201, 649554, 649562, 650943, 650951, 686336, 688339, 688347, 688355, Fritteuse-365, Fritteuse-600, Fritteuse-601, Fritteuse-602, Fritteuse-603, Topline-Fritteuse		

alarm devices

buzzers



1

Varenummer Varenummer	350051	<b>Ref. No.</b>	091472
<b>description</b>	buzzer 230VAC connection male faston 6.3mm screw thread M4 buzzer 62dB		
<b>For models:</b>	367788, 382191, 385018, 385026, 385034, 385042, 385050, 385514, 389595, 389609, 397210, 397431, 398950, 398969, 398977, 505900, 505935, 606294, 606308, 609188, 609196, 637599, 663263, 663395, 670618, 670626, 674648, 674656, 674664, 674680, 674885, 680583, 680591, 686409, 687200, 688096, 688118, 688363, 690570, 690600, 703095, 703109, 703117, 703125, 709816, 709824, 709832, 709840, 733105, 733113...(Other models you can see in the webshop)		

loudspeakers



1

Varenummer Varenummer	350226	<b>Ref. No.</b>	749877
<b>description</b>	loudspeaker ø 64mm built-in depth 20mm 50Ohm 0.3W connection male faston 2.8mm		

contactors

ABB

power contactors



1

Varenummer Varenummer	381011	<b>Ref. No.</b>	EL0502757
<b>description</b>	power contactor resistive load 16A 230VAC (AC3/400V) 9A/4kW main contacts 2NO/2NC auxiliary contacts connection screw connection type B6-22-00		



1

Varenummer Varenummer	380104	<b>Ref. No.</b>	324001 523909
<b>description</b>	power contactor resistive load 25A 230VAC (AC3/400V) 9A/4kW main contacts 3NO auxiliary contacts 1NO connection screw connection type A9-30-10		
<b>For models:</b>	754730, 754749, 757292, 758752, 758760, 758981, 759007, 759015, 759023, 759031, 759058, 759066, 759074, 759171, 759198, 759678, 759686, 759694, 759708, 759716		



GENERAL ELECTRIC (AEG)

power contactors



1			
Varenummer Varenummer	380239	Ref. No.	307491
description	power contactor resistive load 20A 230VAC (AC3/400V) 8.4A/4kW main contacts 3NO auxiliary contacts 1NC connection screw connection type LS05 01A type AEG LS05 01A type GE MC1A 301A		
For models:	271500, 337xxx, 340022, 340030, 340049, 340057, 340073, 340xxx, 353167, 354392, 354457, 361763, 378933, 440078, 440086, 440094, 440140, 440655, 450111, 610038, 610429, 620203, 620424, 668001, 669008, 805556, 810002, 813303, 890502, 890510, 890529, 890553, 890561, 890588, 890596, 890618, 890626, FOEM-Kippbratpfanne-Elektro, Geschirrspuelautomat-330, Geschirrspuelautomat-335, Geschirrspuelautomat-336, Geschirrspuelautomat-700, GsP-350, GsP-500, GsP-600, Heissluftdaempfer-10x1-1, Heissluftdaempfer-5x1-1, Heissluftdaempfer-5x2-3		

ISKRA (FANAL)

power contactors



1			
Varenummer Varenummer	380214	Ref. No.	332682
description	power contactor resistive load 20A 230VAC (AC3/400V) 8.5A/5.5kW main contacts 3NO auxiliary contacts 1NO connection screw connection type Fanal DSL7 00 type ISKRA K07M 00		

auxiliary contacts



1			
Varenummer Varenummer	380225	Ref. No.	332690
description	auxiliary contact contacts 3NO/1NC AC15 6A for contactors K03C/ K07C connection screw connection type Fanal SC4 31 type ISKRA ND4C 31		

TELEMECANIQUE (Schneider Electric)

power contactors



1			
Varenummer Varenummer	381010	Ref. No.	381010
description	power contactor resistive load 20A 230VAC (AC3/400V) 6A/2.2kW main contacts 2x3NO auxiliary contacts 2x1NO connection screw connection type LC2K0610P7		

auxiliary contacts



1			
Varenummer Varenummer	380987	Ref. No.	751790
description	auxiliary contact contacts 3NO/1NC AC15 10A for contactors LC1K connection screw type LA1KN31		

solid state relays

CELDUC



1			
Varenummer Varenummer	402049	Ref. No.	752401
description	solid state relay CELDUC 1 phase 60A 24-600V 3-32VDC L 58mm W 45mm screw type SO965460		
accessories for	402049		
	Varenummer Varenummer	401564	Ref. No.
			—
	heat-conducting foil L 62mm W 45mm for solid state relay		



CRYDOM



1

Varenummer Varenummer	402052	<b>Ref. No.</b>	752665
<b>description</b>	solid state relay CRYDOM 1 phase 90A 600V 4-32VDC L 58.6mm W 45mm screw type H12WD4890PG		

relays

power relays

with flange mounting



1

Varenummer Varenummer	380131	<b>Ref. No.</b>	359289
<b>description</b>	power relays Italiana Relè 230VAC 16A 3CO connection male faston 6.3mm screw mounting manuf. no. B2-3-230AC		
<b>For models:</b>	Glaeserspelautomat-325		

with bracket mounting



1

Varenummer Varenummer	380687	<b>Ref. No.</b>	849618
<b>description</b>	power relays FINDER 230VAC 30A 2NO connection F6.3 bracket mounting manuf. no. 66.82.8.230.0300		

time relays

time relays



1

Varenummer Varenummer	381009	<b>Ref. No.</b>	780421
<b>description</b>	time relay ABB CT-AHE time range 3-300s 220-240VAC 4A		



1

Varenummer Varenummer	380288	<b>Ref. No.</b>	332615
<b>description</b>	time relay ELEKTRON VZE 806 time range 60s 24-250 AC/DC 5A connection cable mounting measurements DIN railmm		
<b>For models:</b>	389595, 389609, 398950, 398969, 398977, 609188, 609196, 637599, 674648, 674656, 674664, 674885, 680583, 680591, Heissluftdaempfer-10x1-1, Heissluftdaempfer-5x2-3, Heissluftdaempfer-6x1-1		

transformers

encapsulated transformers

multiple connections



1

Varenummer Varenummer	400252	<b>Ref. No.</b>	570443
<b>description</b>	transformer		



1

Varenummer Varenummer	400251	<b>Ref. No.</b>	572217
<b>description</b>	transformer 44VA		

1

Varenummer Varenummer	402051	Ref. No.	742775
description	transformer primary 230VAC secondary 16.5VAC 2x15VA connection male faston 50/60Hz		
For models:	754595, 754609, 754617, 754668, 754676, 754681, 754692, 754706, 754714, 754722, 754730, 754749, 754757, 754773, 754781, 757292, 757314, 757365, 757373, 757381, 757403, 757411, 757438, 757446, 757454, 757462, 757470, 758736, 758833, 759201, 759651, 759678, 759686, 759694, 759708, 759716		

PMA



1

Varenummer Varenummer	379054	Ref. No.	368849
description	transformer primary 230VAC secondary 12VAC 3VA secondary 0.25A H 40mm L 45mm W 50mm connection screw 50/60Hz type 153/M		
For models:	Pizza-Ofen-P501, Pizza-Ofen-P502		

## electronic controllers

### SHANGFANG

#### accessories



1

Varenummer Varenummer	379054	Ref. No.	368849
description	transformer primary 230VAC secondary 12VAC 3VA secondary 0.25A H 40mm L 45mm W 50mm connection screw 50/60Hz type 153/M		
For models:	Pizza-Ofen-P501, Pizza-Ofen-P502		

#### miscellaneous

#### universal controllers



1

Varenummer Varenummer	400206	Ref. No.	332143 595047
description	electronic controller 230V TempIn1 thermocouple K (NiCr-Ni) temperature controller		
For models:	389595, 389609, 398950, 398969, 398977, 609188, 609196, 637599, 674648, 674656, 674664, 674680, 674885, Heissluftdaempfer-10x1-1, Heissluftdaempfer-5x2-3, Heissluftdaempfer-6x1-1, Heissluftdaempfer-Varioplus-20x1-1, Heissluftdaempfer-Varioplus-20x2-1		

## probes

### producer-specific probes

#### probes



1

Varenummer Varenummer	379117	Ref. No.	873241
description	core temperature probe Pt100 cable PVC probe -100 up to 450°C cable -10 up to 100°C connection male faston 6.3mm thread 1/4" probe ø4x82mm cable length 1.4m		



1

Varenummer Varenummer	379087	Ref. No.	570621
description	temperature probe thermocouple K (NiCr-Ni) cable silicone probe -50 up to 1150°C cable -50 up to +180°C connection male faston 2.8mm thread probe ø1x30mm cable length 1.6m		

#### core probes



1

Varenummer Varenummer	378358	Ref. No.	747017
description	core temperature probe		



1

Varenummer Varenummer	379592 <sup>1</sup>	Ref. No.	752363
description	core temperature probe 3 point probe cable PTFE probe -40 up to +250°C cable -40 up to +250°C connection 5-wire probe ø4x100mm thread cable length 4.5m handle ø 12mm handle length 85mm		
For models:	754595, 754609, 754617, 754668, 754676, 754681, 754692, 754706, 754714, 754722, 754730, 754749, 754757, 754773, 754781, 757292, 757314, 757365, 757373, 757381, 757403, 757411, 757438, 757446, 757454, 757462, 757470, 758736, 758833, 759201, 759651, 759678, 759686, 759694, 759708, 759716		

<sup>1</sup>multipoint probe



1

Varenummer Varenummer	379692	Ref. No.	783668
description	core temperature probe Pt100 cable PTFE probe -40 up to +250°C cable -40 up to +250°C connection 2-wire probe ø4x82mm thread 1/4" cable length 1.8m handle ø 12mm handle length 90mm		



1 

Varenummer Varenummer	379116	Ref. No.	32664
description	core temperature probe Pt100 cable PTFE probe -40 up to +250°C cable -40 up to +250°C connection 2-wire probe ø4x82mm thread 1/4" cable length 3m handle ø 12mm handle length 90mm		

## electronics

### rectifiers

1 

Varenummer Varenummer	400253	Ref. No.	570532
description	rectifier		

### PCBs

1 

Varenummer Varenummer	402619	Ref. No.	742465
description	keypad PCB combi-steamer 1121/2021 L 350mm W 121mm with display		

1 

Varenummer Varenummer	401000	Ref. No.	580740
description	keypad PCB suitable for ELOMA with display		

1 

Varenummer Varenummer	400013	Ref. No.	214582
description	PCB combi-steamer 6x1/1 5x2/3 level control		
For models:	674524, 674532, 674605, 805556, Heissluftdaempfer-10x1-1, Heissluftdaempfer-20x1-1, Heissluftdaempfer-5x1-1, Heissluftdaempfer-5x2-3		

1 

Varenummer Varenummer	400015	Ref. No.	332704
description	PCB combi-steamer MD 1011 without mounting angle pulse timer for steaming		

## solenoid valves

### solenoid valves (water)

ELBI

straight

1 

Varenummer Varenummer	373017	Ref. No.	883091
description	solenoid valve single straight 230VAC inlet 3/4" outlet 11.5mm DN10 ELBI		
spare parts for	373017		
	Varenummer Varenummer	370467	Ref. No. —
	solenoid valve filter suitable for ELBI		







MÜLLER









medium temperature: 90°C  
duty cycle: 100%



1 

Varenummer Varenummer	370004	Ref. No.	173266 297313
description	solenoid valve double straight 230VAC inlet 3/4" outlet 14.5mm DN10 t.max. 90°C duty cycle 100% MÜLLER		
For models:	144819, 271500, 337xxx, 340022, 340030, 340049, 340057, 340073, 340xxx, 353167, 354392, 354457, 361763, 378933, 440078, 440086, 440094, 440140, 440655, 450111, 516678, 639087, 699063, Geschirrspuelautomat-330, Geschirrspuelautomat-335, Geschirrspuelautomat-336, Geschirrspuelautomat-700, GsP-350, GsP-500, GsP-600, Vario-Braeter-plus		
spare parts for	370004		
	Varenummer Varenummer	370129	Ref. No. —
	solenoid valve body double straight inlet 3/4" outlet 14.5mm DN10 t.max. 90°C duty cycle 100% MÜLLER 230V		
	Varenummer Varenummer	371002	Ref. No. —
	solenoid valve holder MÜLLER flange support		
	Varenummer Varenummer	371009	Ref. No. —
	compression spring for solenoid coil		

Table continues overleaf

<b>spare parts for</b> 370004				
	Varenummer Varenummer	371011	Ref. No.	—
spare parts kit membrane with long star star hight 8mm MÜLLER				
	Varenummer Varenummer	371017	Ref. No.	—
solenoid coil MÜLLER 230VAC connection male faston 6.3mm				
	Varenummer Varenummer	371122	Ref. No.	249688
solenoid valve filter ø 19mm H 10mm suitable for MÜLLER				
	Varenummer Varenummer	501161	Ref. No.	—
tap head for solenoid valve holder for solenoid coils				
<b>accessories for</b> 370004				
	Varenummer Varenummer	371010	Ref. No.	—
solenoid coil 230VAC connection with cable cable length 2000mm				
	Varenummer Varenummer	371037	Ref. No.	—
solenoid coil 24VAC 50/60Hz connection male faston 6.3mm				
	Varenummer Varenummer	371038	Ref. No.	—
solenoid coil 230VAC connection appliance plug				

				
Varenummer Varenummer	370002	<b>Ref. No.</b>	334944	
<b>description</b>	solenoid valve single straight 230VAC inlet 3/4" outlet 14.5mm DN10 t.max. 90°C duty cycle 100% MÜLLER			
<b>For models:</b>	144819, 340022, 340030, 340049, 340057, 340073, 353167, 354392, 354457, 361763, 378933, 440078, 440086, 440094, 440140, 440655, 450111			
<b>spare parts for</b> 370002				
	Varenummer Varenummer	370127	Ref. No.	—
solenoid valve body single straight inlet 3/4" outlet 14.5mm DN10 t.max. 90°C duty cycle 100% MÜLLER 230V				
	Varenummer Varenummer	371002	Ref. No.	—
solenoid valve holder MÜLLER flange support				
	Varenummer Varenummer	371009	Ref. No.	—
compression spring for solenoid coil				
	Varenummer Varenummer	371011	Ref. No.	—
spare parts kit membrane with long star star hight 8mm MÜLLER				
	Varenummer Varenummer	371017	Ref. No.	—
solenoid coil MÜLLER 230VAC connection male faston 6.3mm				
	Varenummer Varenummer	371122	Ref. No.	249688
solenoid valve filter ø 19mm H 10mm suitable for MÜLLER				
	Varenummer Varenummer	501161	Ref. No.	—
tap head for solenoid valve holder for solenoid coils				
<b>accessories for</b> 370002				
	Varenummer Varenummer	371010	Ref. No.	—
solenoid coil 230VAC connection with cable cable length 2000mm				

<b>accessories for</b> 370002				
	Varenummer Varenummer	371037	Ref. No.	—
solenoid coil 24VAC 50/60Hz connection male faston 6.3mm				
	Varenummer Varenummer	371038	Ref. No.	—
solenoid coil 230VAC connection appliance plug				

<b>spare parts and accessories</b>				
<b>filters</b>				
				
1				
Varenummer Varenummer	371122	<b>Ref. No.</b>	249688	
<b>description</b>	solenoid valve filter ø 19mm H 10mm suitable for MÜLLER			











<b>TP</b>				
				
				
1				
Varenummer Varenummer	370017	<b>Ref. No.</b>	987017	
<b>description</b>	solenoid valve single straight 230VAC inlet 3/4" outlet 11.5mm DN10 TP p max 10bar			
<b>spare parts for</b> 370017				
	Varenummer Varenummer	371013	Ref. No.	—
solenoid coil TP 230VAC 50/60Hz				
<b>accessories for</b> 370017				
	Varenummer Varenummer	371220	Ref. No.	—
reducer TP flow rate 3l/min red tolerance ±15%				
	Varenummer Varenummer	371221	Ref. No.	—
reducer TP flow rate 5.5l/min yellow tolerance ±15%				
	Varenummer Varenummer	371222	Ref. No.	—
reducer TP flow rate 6l/min grey tolerance ±15%				
	Varenummer Varenummer	371223	Ref. No.	—
reducer TP flow rate 10l/min white tolerance ±15%				
	Varenummer Varenummer	371224	Ref. No.	—
reducer TP flow rate 12l/min bronze tolerance ±15%				
	Varenummer Varenummer	371225	Ref. No.	—
reducer TP flow rate 16l/min light brown tolerance ±15%				
	Varenummer Varenummer	371226	Ref. No.	—
reducer TP flow rate 20l/min red tolerance ±15%				
	Varenummer Varenummer	371230	Ref. No.	—
reducer TP flow rate 0.25l/min red tolerance ±25%				

Table continues overleaf



accessories for 370017		Varenummer	Ref. No.	
	Varenummer	371231	Ref. No.	—
	reducer TP flow rate 0.35l/min violet tolerance ±25%			
	Varenummer	371232	Ref. No.	—
	reducer TP flow rate 0.5l/min orange tolerance ±25%			
	Varenummer	371233	Ref. No.	—
	reducer TP flow rate 0.8l/min white tolerance ±25%			
	Varenummer	371234	Ref. No.	—
	reducer TP flow rate 1l/min light blue tolerance ±25%			
	Varenummer	371235	Ref. No.	—
	reducer TP flow rate 1.2l/min brown tolerance ±25%			
	Varenummer	371236	Ref. No.	—
	reducer TP flow rate 1.5l/min light brown tolerance ±25%			
	Varenummer	371237	Ref. No.	—
	reducer TP flow rate 2.5l/min yellow tolerance ±25%			
	Varenummer	371238	Ref. No.	—
	reducer TP flow rate 3.4l/min dark green tolerance ±25%			
	Varenummer	371239	Ref. No.	—
	reducer TP flow rate 5l/min black tolerance ±25%			
	Varenummer	371240	Ref. No.	—
	reducer TP flow rate 8l/min blue tolerance ±20%			

metal  
MÜLLER  
2-way

	1		
Varenummer	370069 <sup>1</sup>	Ref. No.	374806
Varenummer			586935
			754471
description	solenoid valve 2-ways 230VAC inlet 1/8" IT outlet 1/8" IT L 30mm water MÜLLER DN10		
For models:	367788, 382191, 385018, 385026, 385034, 385042, 385050, 385514, 389595, 389609, 390003, 397210, 397229, 397237, 397245, 397253, 397261, 397288, 397296, 397318, 397326, 397334, 397342, 397350, 397431, 397776, 397784, 397792, 397806, 397814, 397822, 397830, 397849, 397857, 397865, 397873, 398047, 398055, 398063, 398071, 398098, 398101, 398128, 398136, 398144, 398152, 398950, 398969, 398977, 399019...(Other models you can see in the webshop)		

<sup>1</sup>with adjusting screw

	1		
Varenummer	370037 <sup>1</sup>	Ref. No.	079561
Varenummer			
description	solenoid valve 2-ways 230VAC inlet 1/8" IT outlet M16x1 outer steam MÜLLER		
For models:	805149, 805300, 805408, 805459, 805xxx, 890502, 890510, 890529, 890553, 890561, 890588, 890596, 890618, 890626, Aromacarina, Aromacarina-Dampf, Aromacarina-EsA, Aromacarina-ETA, Aromacarina-ETA-EsA, Heissluftdaempfer-5x2-3		

<sup>1</sup>with adjusting screw

Solenoid valve - accessories

filters

	1		
Varenummer	371122	Ref. No.	249688
Varenummer			
description	solenoid valve filter ø 19mm H 10mm suitable for MÜLLER		

	1		
Varenummer	370863	Ref. No.	889555
Varenummer			
description	bracket thread 3/4" for solenoid valve L 100mm brass		

pressure switches

for coffee machines

ø 45mm

	1		
Varenummer	541015	Ref. No.	030422
Varenummer			301523
description	pressure control ø 45mm pressure range 400/360mbar pressure range 0.4/0.36bar p max 1.02bar pressure connection vertical coffee machine parts connection 1/4" 1CO suitable for Palux, Bremer pressure connection 1/4"		
For models:	674524, 674532, 674605, 805149, 805300, 805408, 805459, 805556, 805xxx, 810002, 813303, 890502, 890510, 890529, 890553, 890561, 890588, 890596, 890618, 890626, Aromacarina, Aromacarina-Dampf, Aromacarina-EsA, Aromacarina-ETA, Aromacarina-ETA-EsA, Heissluftdaempfer-10x1-1, Heissluftdaempfer-20x1-1, Heissluftdaempfer-5x1-1, Heissluftdaempfer-5x2-3, standkaffeemaschine-solomatic-2, standkaffeemaschine-solomatic-4, Wandkaffeemaschine-800		



for combi-steamers



Varenummer Varenummer	541526	Ref. No.	784028
description	pressure control p max 0.5bar pressure connection 1/8"		

fans

axial fans

import



Varenummer Varenummer	601080 <sup>1</sup>	Ref. No.	693456
description	axial fan L 119mm W 119mm H 38mm 230VAC 50/60Hz 23/20W bearing ball bearing connection male faston 2.8mm metal ADDA fan wheel ø 110mm temp.-resist. 70°C		
For models:	671568, 671576, 671584, 671592, 671606, 671614, 671622, 671630, 758752, 758760, 758981, 759007, 759015, 759023, 759031, 759058, 759066, 759074, 759171, 759198		

accessories for	601080			
	Varenummer Varenummer	550898	Ref. No.	—
	connecting cable cable length 2000mm connection F 2.8 connection distance 7.9mm for axial flow fan			
	Varenummer Varenummer	692519	Ref. No.	—
	guard L 120mm W 120mm plastic			

<sup>1</sup>with ball bearings

hot air motors



Varenummer Varenummer	510675	Ref. No.	373621
description	counterflange for fan motor ED ø 60mm int. ø 2 30mm thickness 5mm stainless steel		

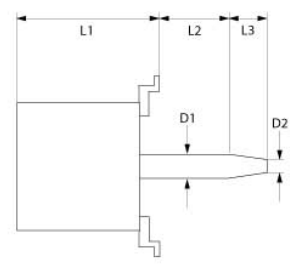

Varenummer Varenummer	500102	Ref. No.	332410
description	fan motor 230-240V 1 phase 50Hz 0.09kW 1390rpm speeds 1 L1 150mm L2 32mm L3 27mm ø 125mm M10R IT 1.1A suitable capacitor 4µF/400V power input 200W at 50Hz 1390rpm type L7yzw4B-207 no. X5 D1 ø 17mm D2 ø 14mm		
For models:	385018, 385026, 385034, 385042, 385050, 385514, 390003, 397229, 397237, 397245, 397253, 397261, 397288, 397296, 397318, 397326, 397334, 397342, 397350, 397776, 397784, 397792, 397806, 397814, 397822, 397830, 397849, 397857, 397865, 397873, 399019, 399027, 399035, 399043, 399051, 399078, 399086, 399094, 399108, 399116, 606294, 606316, 606324, 606332, 606340, 606359, 606367, 609544, 609552, 609560...(Other models you can see in the webshop)		

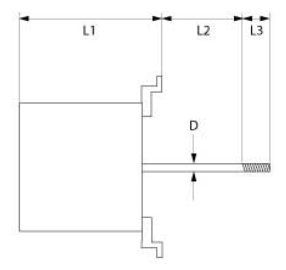

Varenummer Varenummer	601474	Ref. No.	693286	
description	fan motor 230V 1 phase 50/60Hz 0.03kW 3600rpm speeds 1 L1 115mm L2 20mm L3 32mm ø 12mm shaft flat length 23mm 7.5/8 0.35/0.56A suitable capacitor 3µF400V power input 75/125W at 50Hz 3600rpm type L5ow2B-317 no. W9			
For models:	671568, 671576, 671584, 671592, 671606, 671614, 671622, 671630, 758752, 758760, 758981, 759007, 759015, 759023, 759031, 759058, 759066, 759074, 759171, 759198			
spare parts for	601474			
	Varenummer Varenummer	365191	Ref. No.	—
	operating capacitor capacity 3µF 400V tolerance 5% 60Hz ambient temperature max. -40 up to +85°C ø 30mm L 85mm M8 aluminium connection cable 400mm MLR25L40303063			
accessories for	601474			
	Varenummer Varenummer	602166	Ref. No.	693375
	fan wheel blades 9 D1 ø 175mm D2 ø 8mm D3 ø 8mm H1 30mm H2 28mm ED 6-23			

1



Varenummer Varenummer	601871	<b>Ref. No.</b>	302821
<b>description</b>	fan motor 230V 1 phase 50Hz 85kW 2400rpm speeds 1 L1 85mm L2 40mm L3 33mm L4 133.5mm fan wheel ø 180mm at 50Hz 230V at 60Hz 230V at 50Hz 2600rpm at 60Hz 2850rpm type R2E180-AU01-09		
<b>For models:</b>	389595, 389609, 398950, 398969, 398977, 609188, 609196, 637599, 674648, 674656, 674885, Heissluftdaempfer-5x2-3, Heissluftgeraet-5x2-3		

1



Varenummer Varenummer	514535	<b>Ref. No.</b>	743372
<b>description</b>	fan wheel blades 12 D1 ø 350mm D2 ø 13mm D3 ø 16.2mm H1 110mm H2 16mm seat ø 40mm		

2

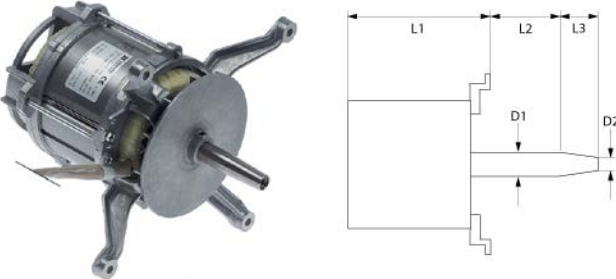

Varenummer Varenummer	500170	<b>Ref. No.</b>	580287
<b>description</b>	fan motor 3 phase		
<b>For models:</b>	671649, 671657, 671665, 671673, 671681, 671711, 671746, 671754, 671762, 671770, 671789, 671797, 671800, 671819, 671827, 671835, 671843, 671851, 671878, 671886, 671894, 671908, 671916, 671975, 671983, 671991, 680583, 680591		

1



Varenummer Varenummer	602166	<b>Ref. No.</b>	693375
<b>description</b>	fan wheel blades 9 D1 ø 175mm D2 ø 8mm D3 ø 8mm H1 30mm H2 28mm ED 6-23		
<b>accessories for</b>	602166		
Varenummer Varenummer	601474	<b>Ref. No.</b>	693286
<b>description</b>	fan motor 230V 1 phase 50/60Hz 0.03kW 3600rpm speeds 1 L1 115mm L2 20mm L3 32mm ø 12mm shaft flat length 23mm 7.5/8 0.35/0.56A suitable capacitor 3µF400V power input 75/125W at 50Hz 3600rpm type L5ow2B-317 no. W9		

1

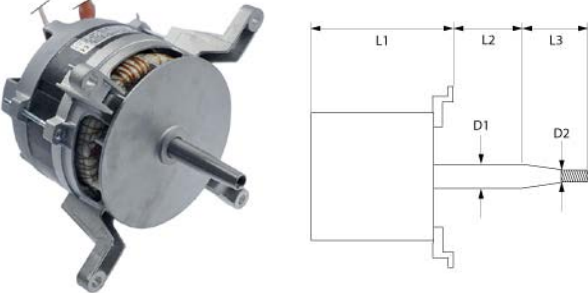

Varenummer Varenummer	601864	<b>Ref. No.</b>	742740
<b>description</b>	fan motor 380-415V 3 phase 50Hz 0.21kW 700/1400rpm speeds 2 L1 160mm L2 25mm L3 40mm D1 ø 17mm D2 ø 13mm M10R IT at 50Hz 700/1400rpm type 3081DH4052		

1



Varenummer Varenummer	510673	<b>Ref. No.</b>	580600
<b>description</b>	flange for fan motor ED ø 60mm int. ø 1 43mm int. ø 2 29mm thickness 6mm stainless steel		

1



Varenummer Varenummer	694997	<b>Ref. No.</b>	782939
<b>description</b>	speed sensor for hot air motors cable length 450mm		



radial fans

miscellaneous



Varenummer Varenummer	601475	Ref. No.	752525
description	radial fan 230V voltage AC 50/60Hz 20W H1 180mm L1 180mm D1 ø 86mm W1 40mm W2 34mm H2 122mm W3 40mm H3 172mm		
For models:	754668, 757314, 757462, 757470		

fuses

fine fuses

1			
Varenummer Varenummer	358532	Ref. No.	190756
description	fine fuse size ø5x20mm 2A fast-acting rated 250V Qty 10 pcs		

1			
Varenummer Varenummer	358608	Ref. No.	578975
description	fine fuse size ø5x20mm 10A slow-acting rated 250V Qty 10 pcs		

pumps

vibration pumps



Varenummer Varenummer	499010	Ref. No.	772550
description	vibration pump type E512/B46 230V 60W 50/60Hz inlet ø 7 outlet ø 1/8" IT CEME L 125mm		

fine fuse holders

1			
Varenummer Varenummer	358049	Ref. No.	751847
description	fuse holder		

1			
Varenummer Varenummer	550105	Ref. No.	326941
description	rail-mounted terminal WIELAND type WK10/SIU 5X20 /V0 suitable fuse ø5x20mm 1.0-16mm <sup>2</sup> 10A rated 250V		

condensators & interference suppression filters

operating capacitors

metal

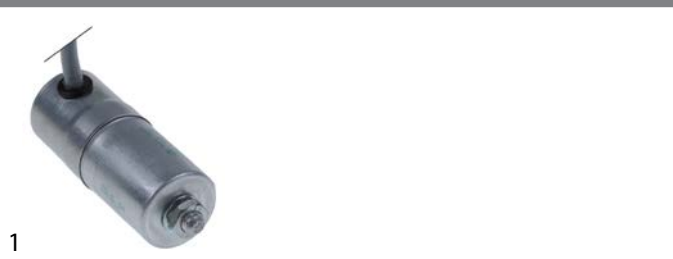

Varenummer Varenummer	365002	Ref. No.	292753
description	operating capacitor capacity 4µF 400V tolerance 5% 50/60Hz ambient temperature max. -25 to +85°C ø 30mm L 75mm with cable M8 aluminium connection cable 300mm MKP protection IP65		

screw locks

D0-system (NEOZED)

1			
Varenummer Varenummer	358043	Ref. No.	658294
description	fuse size D01 16A rated 250/400V E14 ø 11mm L 36mm Qty 10 pcs		

1			
Varenummer Varenummer	358045	Ref. No.	751863
description	fuse size D02 35A rated 250/400V E18 ø 15mm L 36mm Qty 10 pcs		



 <p>1</p>			
Varenummer Varenummer	358046	Ref. No.	658286
description	fuse size D02 50A rated 250/400V E18 ø 15mm L 36mm Qty 10 pcs		

<p>gauge pieces (NEOZED)</p>			
 <p>1</p>			
Varenummer Varenummer	358067	Ref. No.	751855
description	gauge piece size D02 suitable for 35A		

 <p>1</p>			
Varenummer Varenummer	358068	Ref. No.	658278
description	gauge piece size D02 suitable for 50A		

## electric accessories

### terminals



<p>connection terminals with screw/faston connections</p>			
 <p>1</p>			
Varenummer Varenummer	550762	Ref. No.	070858
description	connection terminal 2-pole max. 16A max 400V connection ø2.5mm <sup>2</sup> / F6.3 temp.-resist. 150°C		
For models:	140902, 144819, 361763, 378933, 440078, 440086, 440094, 440140, 440655, 450111, 502200, 502308, 502650, 502707, 503010, 503150, 505900, 505935, 515892, 515906, 516678, 517887, 541869, 626104, 626112, 626201, 626228, 626309, 626317, 637564, 638625, 639087, 649554, 649562, 650943, 650951, 657735, 663263, 663395, 667412, 670618, 670626, 684848, 686298, 686328, 686336, 686409, 687200, 688096, 688118...(Other models you can see in the webshop)		

<p>rail-mounted terminals</p>			
<p>WIELAND</p>			
<p>fuse terminal blocks</p>			
 <p>1</p>			
Varenummer Varenummer	550105	Ref. No.	326941
description	rail-mounted terminal WIELAND type WK10/SIU 5X20 /V0 suitable fuse ø5x20mm 1.0-16mm <sup>2</sup> 10A rated 250V		

<p>accessories</p>			
 <p>1</p>			
Varenummer Varenummer	550337	Ref. No.	327514
description	end barrier for fuse terminal clampsmm <sup>2</sup>		

## gas valves and ignition boxes

### gas control valves









<p>HONEYWELL</p>			
 <p>1</p>			
Varenummer Varenummer	106206	Ref. No.	744050
description	gas valve type VK4115V 220-240V 50/60Hz gas inlet flange 32x32mm gas outlet flange 32x32mm thermocouple connection pilot connection pressure range 15-60mbar max 60mbar operator type HONEYWELL suitable for hole distance 24mm flange 32x32mm		
accessories for	106206		
	Varenummer Varenummer	102845	Ref. No. —
	gas connection angled 1/2" flange 32x32mm hole distance 24x24mm Tandem		
	Varenummer Varenummer	102846	Ref. No. —
	gas connection straight 1/2" flange 32x32mm hole distance 24x24mm suitable for Tandem		



SIT

ELETTROSIT



1				
Varenummer Varenummer	101127	Ref. No.	321907	
description	gas valve SIT type ELETTROSIT 230V gas inlet 3/4" gas outlet 3/4" thermocouple connection M9x1 pilot connection M10x1 lateral equiv. no. 0.810.175			
spare parts for	101127			
	Varenummer Varenummer	101312	Ref. No.	—
	microswitch			
	Varenummer Varenummer	101352	Ref. No.	—
	solenoid coil 230V 50Hz suitable for ELETTROSIT			
accessories for	101127			
	Varenummer Varenummer	100006	Ref. No.	—
	piezoelectric igniter suitable for ELETTROSIT body plastic blowing connection ø2.4mm ø 14mm			
	Varenummer Varenummer	100904	Ref. No.	—
	locking screw M10x1 for pipe ø 4mm Qty 1 pcs			
	Varenummer Varenummer	100905	Ref. No.	—
	locking screw M10x1 for pipe ø 6mm Qty 1 pcs			
	Varenummer Varenummer	101301	Ref. No.	—
	gas connection thread 1/2" straight ELETTROSIT screw with O-ring			
	Varenummer Varenummer	101303	Ref. No.	—
	gas connection straight thread 3/4" ELETTROSIT			
	Varenummer Varenummer	101309	Ref. No.	—
	extension			

ignition boxes

HONEYWELL



1				
Varenummer Varenummer	101166	Ref. No.	371416	
description	ignition box HONEYWELL type S4560B 1006 electrodes 1 waiting time 0s safety time 10s 220-240V 10VA 50Hz			

ignition parts

pilot burners

SIT

100 series















1				
Varenummer Varenummer	106907	Ref. No.	321400 321699	
description	pilot burner SIT type 100 series 3 flames nozzle ø 0.35mm gas connection 6mm			
For models:	710024, 710040, 710059, 710067, 910023, 910047, 910058, 910066, 910082, 910090, 910104, 910112, 910139, 910147, 910155, 910163, 910457, 910473, FOEM-Gas-Backofen			
spare parts for	106907			
	Varenummer Varenummer	100246	Ref. No.	—
	pilot burner nozzle natural gas bore ø 0.35mm Qty 1 pcs thread M8x0.75			
	Varenummer Varenummer	100855	Ref. No.	—
	pilot burner bracket triple			
	Varenummer Varenummer	100885	Ref. No.	—
	air mixing sleeve for pilot burner Qty 1 pcs			
	Varenummer Varenummer	100916	Ref. No.	—
	compression spring for pilot burner Qty 1 pcs			
	Varenummer Varenummer	100917	Ref. No.	—
	gasket for pilot burner Qty 1 pcs aluminium ID ø 8.5mm ED ø 11mm thickness 1.2mm			
	Varenummer Varenummer	100918	Ref. No.	—
	screw for pilot burner			
	Varenummer Varenummer	107162	Ref. No.	—
	pilot burner cap SIT 3 flames Hmm Lmm Qty 1 pcs			
	Varenummer Varenummer	107702	Ref. No.	—
	pilot burner bottom part SIT 100 series nozzle ø 0.35mm			

Table continues overleaf



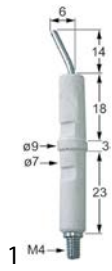

accessories for		106907	
	Varenummer Varenummer	100245	Ref. No. —
pilot burner nozzle LPG code 20 bore $\varnothing$ 0.2mm Qty 1 pcs thread M8x0.75			
	Varenummer Varenummer	100904	Ref. No. —
locking screw M10x1 for pipe $\varnothing$ 4mm Qty 1 pcs			
	Varenummer Varenummer	100905	Ref. No. —
locking screw M10x1 for pipe $\varnothing$ 6mm Qty 1 pcs			
	Varenummer Varenummer	102110	Ref. No. —
pilot tube copper pipe $\varnothing$ 4mm thickness 1mm L 3000mm			
	Varenummer Varenummer	102111	Ref. No. —
pilot tube copper pipe $\varnothing$ 6mm thickness 1mm L 3000mm			
	Varenummer Varenummer	107171	Ref. No. —
pilot burner nozzle SIT natural/liquid gas bore $\varnothing$ 0.25mm Qty 1 pcs			
	Varenummer Varenummer	107700	Ref. No. —
pilot burner bottom part SIT 100 series nozzle $\varnothing$ 0.25mm			
	Varenummer Varenummer	107701	Ref. No. —
pilot burner bottom part SIT 100 series nozzle $\varnothing$ 0.2mm			

	Varenummer Varenummer	100706	Ref. No.	321419
1 M4				
<b>description</b> ignition electrode connection M4 Qty 1 pcs				
<b>For models:</b> 710059, 710067, 710083, 910023, 910047, 910058, 910066, 910082, 910090, 910104, 910112, 910139, 910147, 910155, 910163, 910457, 910473				

accessories

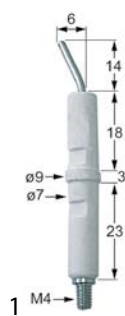
ignition electrodes

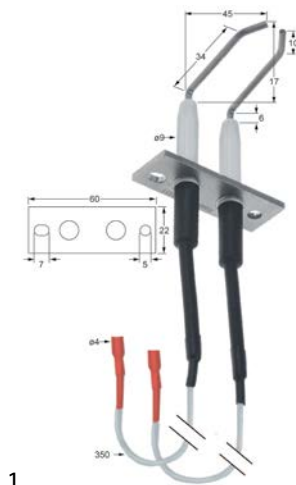
	Varenummer Varenummer	100706	Ref. No.	321419
1 M4				
<b>description</b> ignition electrode connection M4 Qty 1 pcs				
<b>For models:</b> 710059, 710067, 710083, 910023, 910047, 910058, 910066, 910082, 910090, 910104, 910112, 910139, 910147, 910155, 910163, 910457, 910473				

	Varenummer Varenummer	106996	Ref. No.	874787
1				
<b>description</b> ignition electrode flange length 60mm flange width 22mm D1 $\varnothing$ 9mm L1 17mm L2 45mm L3 6mm L4 34/10mm BL1 37mm BL2 32mm cable length 350mm connection $\varnothing$ 4mm				
<b>accessories for</b> 106996				
	Varenummer Varenummer	699472	Ref. No.	874833
<b>description</b> gasket ignition electrode ID $\varnothing$ 13mm hole $\varnothing$ 6mm L 60mm W 22mm suitable for ELOMA graphite				

electrodes

	Varenummer Varenummer	699472	Ref. No.	874833
1				
<b>description</b> gasket ignition electrode ID $\varnothing$ 13mm hole $\varnothing$ 6mm L 60mm W 22mm suitable for ELOMA graphite				

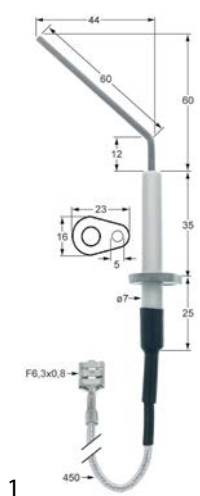
	Varenummer Varenummer	106997	Ref. No.	874906
1				
<b>description</b> monitoring electrode connection $\varnothing$ F6.3mm flange length 23mm flange width 16mm D1 $\varnothing$ 7mm L1 60mm L2 44mm L4 12mm L3 60mm BL1 35mm BL2 25mm connection F6.3x0.8 cable length 450mm fixing dimensions $\varnothing$ 5mm				

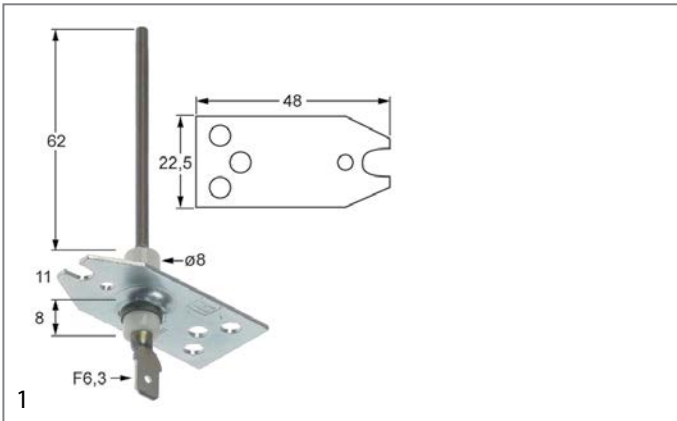

Varenummer Varenummer	109120	Ref. No.	373834
<b>description</b>	monitoring electrode flange length 48mm D1 ø 8mm flange width 22.5mm L1 62mm BL1 11mm BL2 8mm connection male faston 6.3mm		



Varenummer Varenummer	100906	Ref. No.	835803
<b>description</b>	screw connection thread M10x1 for ignition electrode brass Qty 1 pcs WS 10		

## thermocouples

### plug-in thermocouples

### plug-in thermocouples standard

#### with barrel socket ø5mm - type Junkers with aluminised tip

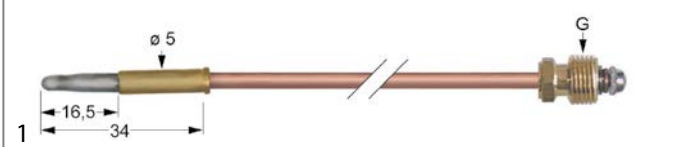

Varenummer Varenummer	102205	Ref. No.	697443
<b>description</b>	thermocouple M8x1 L 750mm plug connection ø5.0mm		
<b>For models:</b>	399701, 399728, 541419, 541427, 800163, 800171, 800198, 800201, 800228, 800236, 800244, 800252, 800260, 800279, 800287, 800295		

<b>accessories for</b>	102205		
		Varenummer Varenummer	101260
		Ref. No.	—
			thermocouple fitting thread M8x1 Qty 1 pcs

#### with barrel socket ø6mm

#### type Junkers with aluminised tip

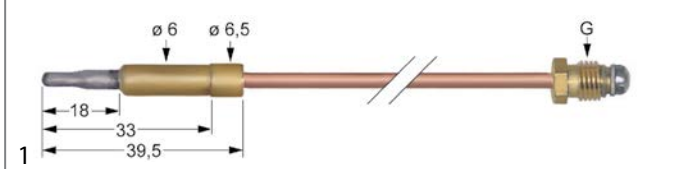

Varenummer Varenummer	102218	Ref. No.	384267
<b>description</b>	thermocouple M8x1 L 320mm plug connection ø6.0mm		
<b>For models:</b>	750123, 750131, 750158, 750166, 750174, 750182, 750190, 750379, 750387		



Varenummer Varenummer	102220	Ref. No.	384275
<b>description</b>	thermocouple M8x1 L 600mm plug connection ø6.0mm		
<b>For models:</b>	750123, 750131, 750158, 750166, 750174, 750182, 750190		

#### with barrel socket ø6(6.5)mm

#### thermocouples SIT

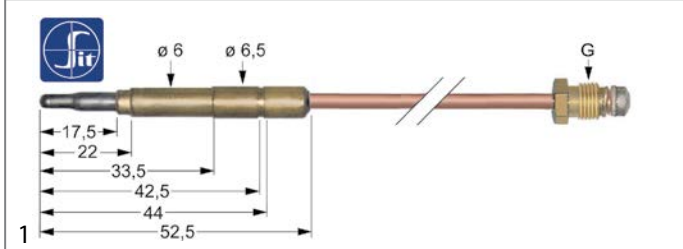

Varenummer Varenummer	107609	Ref. No.	321702
<b>description</b>	thermocouple SIT M9x1 L 600mm plug connection ø6.0(6.5)mm		
<b>For models:</b>	710059, 710067, 910104, 910112, 910139		

## threaded thermocouples

### threaded thermocouples standard

#### with socket with thread M8x1

#### SIT

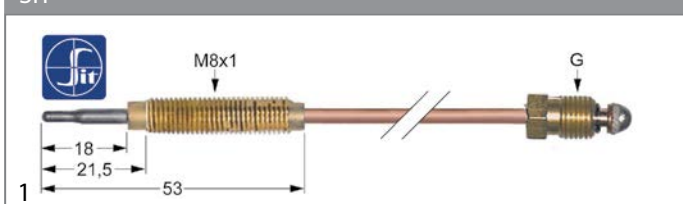

Varenummer Varenummer	107632	Ref. No.	001198
<b>description</b>	thermocouple SIT M8x1 L 1000mm M8x1		
<b>For models:</b>	Gasherd-64502		

<b>accessories for</b>	107632		
		Varenummer Varenummer	102067
		Ref. No.	054240
			nut thread M8x1 H 3mm brass Qty 1 pcs type SEF 1



accessories

nuts



1

Varenummer Varenummer	102067	Ref. No.	054240
description	nut thread M8x1 H 3mm brass Qty 1 pcs type SEF 1		
For models:	399701, 399728, 541419, 541427, 640018, 642053, 645005, 800163, 800171, 800198, 800201, 800228, 800236, 800244, 800252, 800260, 800279, 800287, 800295, Gas-Brater-641, Gas-Griddleplatte-642, Gasher-645, Gasher-64502, Gasher-646, Gas-sudpfanne-643, Gas-Wurstgrill-640, Maxima-Gasher-700-850, Maxima-Gasher-neue-Ausfuehrung-700-850		

union screws



1

Varenummer Varenummer	100906	Ref. No.	835803
description	screw connection thread M10x1 for ignition electrode brass Qty 1 pcs WS 10		

## gas nozzles

### main nozzles

gas nozzles M13x1



1

Varenummer Varenummer	102471	Ref. No.	881715
description	gas injector thread M13x1 bore ø 2.3mm WS 13		

## consumables

### thread sealants



1

Varenummer Varenummer	890058	Ref. No.	593567
description	thread sealing LOCTITE 511 liquid bottle 50ml		
description	LOCTITE® 511™ - bottle 50ml It is designed for the locking and sealing of metal threaded pipes and fittings. The product cures rapidly when confined in the absence of air between close fitting metal surfaces.		

### pilot burner nozzles

pilot burner nozzles POLIDORO



1

Varenummer Varenummer	102699	Ref. No.	835765
description	pilot burner nozzle POLIDORO natural gas code 25.2 bore ø 2x0.25mm Qty 1 pcs 2 bores		

## equipmentspecific units

### for convection ovens/combi-steamers

bushes



1



Varenummer Varenummer	692909	Ref. No.	782432
description	bushing for door hinge H 7mm plastic D1 ø 18mm D2 ø 12mm ID ø 10mm		

### screw connections

olives



1

Varenummer Varenummer	101273	Ref. No.	959715	
description	olive for pipe ø 12mm L 9.5mm brass Qty 1 pcs suitable for universal			
accessories for	101273			
	Varenummer Varenummer	100944	Ref. No.	—
	union nut thread M18x1.5 for pipe ø 12mm			
	Varenummer Varenummer	101276	Ref. No.	—
	union screw thread 3/8" tube ø 12mm Qty 1 pcs			

### injection pipes



1

Varenummer Varenummer	692838	Ref. No.	753793
description	injection pipe for combi-steamer straight ED ø 12mm ID ø 8mm L 180mm -		



			
1			
Varenummer Varenummer	692839	Ref. No.	743267
description	injection pipe for combi-steamer U-shape ED ø 12mm ID ø 10mm L 265mm		

## cleaning system

## coupling bushings

			
1			
Varenummer Varenummer	501591	Ref. No.	753890
description	hose connector stainless steel hose ø 10/13mm M9 for cleaning system combi-steamer		

## cleaning arms

			
1			
Varenummer Varenummer	542416	Ref. No.	775177
description	mounting flange ø 55mm hub with gasket for wash arm suitable for ELOMA combi-steamer		

## drip water trays

			
1			
Varenummer Varenummer	699837	Ref. No.	699837
description	drip tray with grip fixing L 530mm W 52mm H 25mm		

			
1			
Varenummer Varenummer	699269	Ref. No.	699269
description	plug H 10mm ø 20mm		

			
1			
Varenummer Varenummer	699270	Ref. No.	781185
description	spring L 65mm W 32.5mm H 28mm		

## door mechanics

## miscellaneous

			
1			
Varenummer Varenummer	692909	Ref. No.	782432
description	bushing for door hinge H 7mm plastic D1 ø 18mm D2 ø 12mm ID ø 10mm		

## door bumpers

			
1			
Varenummer Varenummer	694922	Ref. No.	886726
description	rubber pad ø 11.5mm H 19mm rubber		

## locking mechanism

			
1			
Varenummer Varenummer	692714	Ref. No.	791652EL
description	disc for catch ø 44mm hole ø 6x8mm		

			
1			
Varenummer Varenummer	692716	Ref. No.	501239EL
description	door catch with switch L 140mm W 25mm H 63mm hole distance 120mm ID ø 12mm		



1			
Varenummer Varenummer	692715	Ref. No.	775061 888575
description	sleeve ø 50mm L 72mm W 59mm H 31mm hole distance 60mm ID ø 37mm		

accessories			
1			
Varenummer Varenummer	699836	Ref. No.	569593
description	plug for door W 32mm plastic L 50mm		

vibration pumps			
1			
Varenummer Varenummer	499010	Ref. No.	772550
description	vibration pump type E512/B46 230V 60W 50/60Hz inlet ø 7 outlet ø 1/8" IT CEME L 125mm		

miscellaneous			
1			
Varenummer Varenummer	696857	Ref. No.	566594
description	boot L 42mm D1 ø 12mm D2 ø 36mm		

1			
Varenummer Varenummer	692306	Ref. No.	213519
description	pipe long D1 ø 10mm D2 ø 6mm L 134mm WS 19 thread 3/8"		
For models:	389595, 389609, 390003, 397229, 397237, 397245, 397253, 397261, 397288, 397296, 397318, 397326, 397334, 397342, 397350, 397776, 397784, 397792, 397806, 397814, 397822, 397830, 397849, 397857, 397865, 397873, 398047, 398055, 398063, 398071, 398098, 398101, 398128, 398136, 398144, 398152, 398950, 398969, 398977, 399019, 399027, 399035, 399043, 399051, 399078, 399086, 399094, 399108, 399116, 606316...(Other models you can see in the webshop)		

## knobs

### universal knobs

1			
Varenummer Varenummer	110235	Ref. No.	341894
description	knob energy regulator 1-3 t.max.°C ø 50mm shaft ø 6x4.6mm shaft flat upper black		
For models:	610038, 610429, 620203, 620424		

1			
Varenummer Varenummer	110244	Ref. No.	649058
description	knob thermostat t.max. 250°C ø 50mm shaft ø 6x4.6mm shaft flat upper/lower black temperature range 30-250°C rotation 270°		
For models:	626104, 626112, 626201, 626228, 626309, 626317		

1			
Varenummer Varenummer	110245	Ref. No.	087432 279862
description	knob thermostat t.max. 300°C ø 50mm shaft ø 6x4.6mm shaft flat upper black temperature range 50-300°C		
For models:	610003, 610038, 610402, 611018, 611050, 611220, 612006, 612057, 620009, 621005, 621056, 621110, 622001, 622052, 62510, 62520, 62530, 626104, 626112, 626201, 626228, 626309, 626317, 629006, 629022, Backofen-629, Brater-611, Brater-621, Griddle-Platte-612, Griddleplatte-622, Grill-680, Grill-681, Grill-682, Grill-683, Heissluftgeraet-672, Heissluftgeraet-673, Heissluftgeraet-67310, Wurstgrill-610, Wurstgrill-620		

### producer-specific knobs

#### PALUX

1			
Varenummer Varenummer	110235	Ref. No.	341894
description	knob energy regulator 1-3 t.max.°C ø 50mm shaft ø 6x4.6mm shaft flat upper black		
For models:	610038, 610429, 620203, 620424		



1

Varenummer Varenummer	110244	Ref. No.	649058
description	knob thermostat t.max. 250°C ø 50mm shaft ø 6x4.6mm shaft flat upper/lower black temperature range 30-250°C rotation 270°		
For models:	626104, 626112, 626201, 626228, 626309, 626317		



1

Varenummer Varenummer	110245	Ref. No.	087432 279862
description	knob thermostat t.max. 300°C ø 50mm shaft ø 6x4.6mm shaft flat upper black temperature range 50-300°C		
For models:	610003, 610038, 610402, 611018, 611050, 611220, 612006, 612057, 620009, 621005, 621056, 621110, 622001, 622052, 62510, 62520, 62530, 626104, 626112, 626201, 626228, 626309, 626317, 629006, 629022, Backofen-629, Brater-611, Brater-621, Griddle-Platte-612, Griddleplatte-622, Grill-680, Grill-681, Grill-682, Grill-683, Heissluftgeraet-672, Heissluftgeraet-673, Heissluftgeraet-67310, Wurstgrill-610, Wurstgrill-620		

accessories

covers



1

Varenummer Varenummer	111510	Ref. No.	748781 883136
description	lid t.max.°C°C ø 37mm shaft ømm shaft flat silver for knob ELOMA		
For models:	754595, 754609, 754617, 754668, 754676, 754681, 754692, 754706, 754714, 754722, 754730, 754749, 754757, 754773, 754781, 757292, 757314, 757365, 757373, 757381, 757403, 757411, 757438, 757446, 757454, 757462, 757470, 758736, 758833, 759201, 759651, 759678, 759686, 759694, 759708, 759716		
accessories for	111510		
	Varenummer Varenummer	111498	Ref. No. 743690
	knob t.max.°C°C ø 48mm shaft ø 6.5mm shaft flat blue		

locks

handle latches

producer-specific

PALUX



1

Varenummer Varenummer	694067	Ref. No.	747998
description	door catch with spigot 1-stage L 26mm total length 51mm thread M8		



1

Varenummer Varenummer	694254	Ref. No.	758272
description	door catch with spigot 2-stage L 36mm total length 60mm thread M8 thread L 25mm mounting pos. hinged at left		





1

Varenummer Varenummer	694253	Ref. No.	758264
description	door catch with spigot 2-stage L 36mm total length 60mm thread M8 thread L 25mm mounting pos. hinged at right		







1

Varenummer Varenummer	691990	Ref. No.	748765
description	door handle hinged at right L 155mm W 60mm H 58mm spring length 53mm blue mounting distance 40mm mounting thread M4		
For models:	754595, 754609, 754617, 754668, 754676, 754681, 754692, 754706, 754714, 754722, 754730, 754749, 754757, 754773, 754781, 757292, 757314, 757365, 757373, 757381, 757403, 757411, 757438, 757446, 757454, 757462, 757470, 758736, 758833, 759201, 759651, 759678, 759686, 759694, 759708, 759716		
spare parts for	691990		
	Varenummer Varenummer	514450	Ref. No. —
	spring for door handle ø 6mm L 61mm W 27.5mm		
accessories for	691990		
	Varenummer Varenummer	111510	Ref. No. 748781 883136
	lid t.max.°C°C ø 37mm shaft ømm shaft flat silver for knob ELOMA		

1

Varenummer Varenummer	691988	<b>Ref. No.</b>	749532
<b>description</b>	door handle L 155mm W 60mm H 58mm spring length 53mm blue mounting distance 40mm spring thickness 3mm		
<b>accessories for</b>	691988		
	Varenummer Varenummer	111510	Ref. No. 748781 883136
	lid t.max.°C ø 37mm shaft ømm shaft flat silver for knob ELOMA		

<b>accessories for</b>	690808		
	Varenummer Varenummer	690111	Ref. No. —
	base plate H 2mm L 38mm W 11mm mounting distance 26mm plastic		
	Varenummer Varenummer	690114	Ref. No. —
	base plate H 3.5mm L 185mm W 30mm mounting distance 150mm with inclination thread M5		
	Varenummer Varenummer	700082	Ref. No. —
	door catch L 38mm W 18mm mounting distance 26mm		

## edgmount latches

### handle latches

#### CAFF/FERMOD

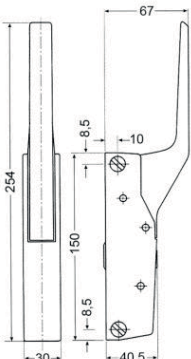

1

 Image not available

Varenummer Varenummer	701453	<b>Ref. No.</b>	215767 377732
<b>description</b>	handle latch L 150mm mounting distance 133mm metal heated units W 29.7mm type 790 / 791 total length 250mm handle length 100mm overall height 67mm		

## door catches



1

Varenummer Varenummer	700061	<b>Ref. No.</b>	382833
<b>description</b>	door catch L 58mm W 20mm H 35mm mounting distance 42mm chrome-plated brass for headed units		
<b>accessories for</b>	700061		
 Image not available	Varenummer Varenummer	690414	Ref. No. —
	handle latch L 150mm mounting distance 133mm non lockable refrigeration units G 791		

## hinges

### edgmount hinges

#### STUV

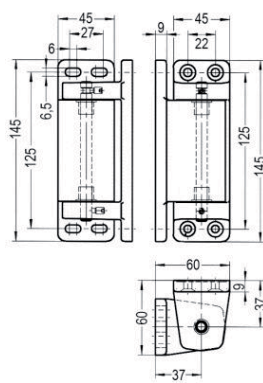



1

Varenummer Varenummer	700073	<b>Ref. No.</b>	000051
<b>description</b>	edgmount hinge L 145mm W 45mm mounting distance 125mm hinging left/right without lift centre of rotation 37mm zinc die cast, chrome-plated refrigeration units		
<b>accessories for</b>	700073		
	Varenummer Varenummer	690310	Ref. No. —
	base plate for 4000/4001 series thickness 5mm		

### RAHRBACH

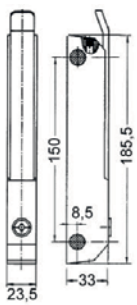
#### 6188 ERGO series

1

Varenummer Varenummer	690808	<b>Ref. No.</b>	565458
<b>description</b>	handle latch L 185mm mounting distance 150mm chrome-plated non lockable for headed units 6188 type ERGO		
<b>accessories for</b>	690808		
	Varenummer Varenummer	690110	Ref. No. —
	base plate H 1mm L 38mm W 11mm mounting distance 26mm plastic		

## door bearing



1

Varenummer Varenummer	692688	Ref. No.	569178
description	hinge L 78mm W 40mm H 5mm mounting distance 21mm mounting pos. lower bolt 12mm bolt ø 6mm		

## accessories

## bushes



1

Varenummer Varenummer	692909	Ref. No.	782432
description	bushing for door hinge H 7mm plastic D1 ø 18mm D2 ø 12mm ID ø 10mm		

## miscellaneous



1

Varenummer Varenummer	694994	Ref. No.	875023
description	locking disc for hinge ID ø 12mm ED ø 30mm plastic		

## pullouts

## rollers

## rollers

## accessories



1

Varenummer Varenummer	560133	Ref. No.	251887
description	hexagonal nut thread M6 H 5mm WS 10 SS DIN/ISO DIN 934 / ISO 4032/8673 Qty 20 pcs		
For models:	140902, 144819, 271500, 337xxx, 340022, 340030, 340049, 340057, 340073, 340xxx, 353167, 354392, 354457, 354643, 354651, 354678, 354686, 354694, 354708, 361429, 361437, 361763, 367788, 378933, 382191, 385018, 385026, 385034, 385042, 385050, 385514, 389595, 389609, 390003, 397210, 397229, 397237, 397245, 397253, 397261, 397288, 397296, 397318, 397326, 397334, 397342, 397350, 397431, 397776, 397784...(Other models you can see in the webshop)		

## DERBY RUOTE

## spare parts and accessories

## miscellaneous



1

Varenummer Varenummer	560193	Ref. No.	349771
description	tooth lock washer ID ø 10.4mm ED ø 18mm zinc-coated steel DIN/ISO DIN 6798A Qty 1 pcs for thread M10		

## gaskets

## gaskets for heated units

## window seals

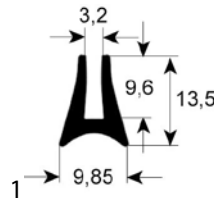

1

Varenummer Varenummer	900110	Ref. No.	215961
description	window gasket profile 1590 Qty supplied by meter		

## door seals

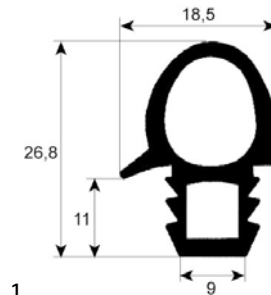

1

Varenummer Varenummer	900100	Ref. No.	384410
description	door seal profile 2070 W 460mm L 645mm external size Qty 1 6 x 1/1		

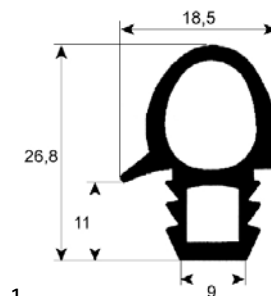

1

Varenummer Varenummer	900101	Ref. No.	382310
description	door seal profile 2070 W 645mm L 700mm external size Qty 1 10 x 1/1		
For models:	367788, 382191, 385018, 385026, 385034, 385042, 385050, 385514, 397210, 397229, 397237, 397245, 397253, 397261, 397288, 397296, 397318, 397326, 397334, 397342, 397350, 397431, 606294, 606308, 646768, 646776, 646784, 646792, 646806, 646814, 646822, 646830, 646849, 646857, 646865, 646873, 671789, 671797, 671800, 671819, 671827, 671835, 671843, 671851, 671878, 671886, 680583, 680591		



Varenummer Varenummer	900203	<b>Ref. No.</b>	425090
<b>description</b>	door seal profile 2448 W 730mm L 980mm external size Qty 1		

Varenummer Varenummer	901490	<b>Ref. No.</b>	742406
<b>description</b>	door seal profile 2449 W 690mm L 1550mm Qty 1		

Varenummer Varenummer	900865	<b>Ref. No.</b>	742368
<b>description</b>	door seal profile 2449 W 490mm L 520mm Qty 1		
<b>For models:</b>	754595, 754609, 754676, 754681, 754692, 754706, 754749, 757365, 757373, 757381, 757403, 758736, 759201, 759678, 759686, 759694		

Varenummer Varenummer	901277	<b>Ref. No.</b>	E425207
<b>description</b>	door seal profile 2690 L 2275mm		

Varenummer Varenummer	901483	<b>Ref. No.</b>	742384
<b>description</b>	door seal profile 2449 W 520mm L 1505mm Qty 1		

Varenummer Varenummer	902491	<b>Ref. No.</b>	501645
<b>description</b>	door seal profile 2710 L 1555mm suitable for ELOMA closed		

Varenummer Varenummer	900497	<b>Ref. No.</b>	742376
<b>description</b>	door seal profile 2449 W 520mm L 775mm Qty 1		
<b>For models:</b>	754617, 754714, 754722, 754730, 754757, 754773, 754781, 757292, 757411, 757438, 757446, 757454, 758833, 759651, 759708, 759716		

Varenummer Varenummer	900050	<b>Ref. No.</b>	131385
<b>description</b>	door seal profile 2710 Qty supplied by meter		

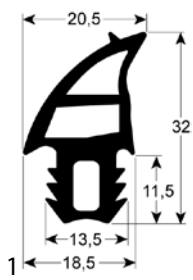

Varenummer Varenummer	902492	Ref. No.	742392
description	door seal profile 2736 W 695mm L 1000mm outer plug size Qty 1 suitable for ELOMA 12-21 silicone		

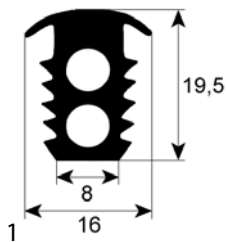

Varenummer Varenummer	901298	Ref. No.	693200
description	door seal profile 2775 Qty supplied by meter		

## gaskets for tray rack trolleys

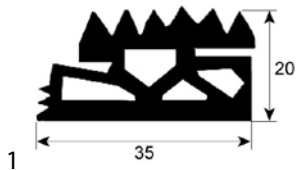

Varenummer Varenummer	900199	Ref. No.	549207
description	tray rack trolley gasket profile 4070 L 1000mm Qty 1		

## gaskets for control panels



Varenummer Varenummer	902493	Ref. No.	742309
description	gasket for control panel W 220mm L 890mm suitable for ELOMA for combi-steamer with 8 mounting clips		

## O-rings

## EPDM

ø1.78mm



Varenummer Varenummer	504574	Ref. No.	013471
description	O-ring EPDM thickness 1.78mm ID ø 9.25mm Qty 1 pcs		
For models:	140902, 367788, 382191, 385018, 385026, 385034, 385042, 385050, 385514, 389595, 389609, 390003, 397210, 397229, 397237, 397245, 397253, 397261, 397288, 397296, 397318, 397326, 397334, 397342, 397350, 397431, 397776, 397784, 397792, 397806, 397814, 397822, 397830, 397849, 397857, 397865, 397873, 398047, 398055, 398063, 398071, 398098, 398101, 398128, 398136, 398144, 398152, 398950, 398969, 398977...(Other models you can see in the webshop)		

ø5.34mm



Varenummer Varenummer	510408	Ref. No.	349232
description	O-ring EPDM thickness 5.34mm ID ø 47mm Qty 1 pcs		
For models:	665843, 665851, Glaeserspuelautomat-325, Glaeserspuelautomat-328		

ø7,00mm

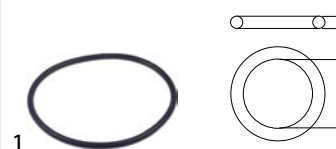

Varenummer Varenummer	532601	Ref. No.	335770
description	O-ring EPDM thickness 7mm ID ø 135.89mm Qty 1 pcs		
For models:	353167, 354392, 354457, 361763, 378933, 440078, 440086, 440094, 440140, 440655, 450111, GsP-350		

## silicone

ø1.50mm

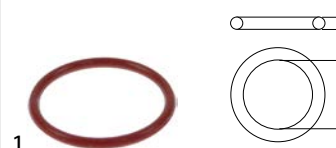

Varenummer Varenummer	532726	Ref. No.	577642
description	O-ring silicone thickness 1.5mm ID ø 17mm Qty 10 pcs		



**Viton**

ø2.62mm

1

Varenummer Varenummer	510579	<b>Ref. No.</b>	581410
<b>description</b>	O-ring Viton thickness 2.62mm ID ø 34.6mm Qty 1 pcs		

ø3.53mm

1

Varenummer Varenummer	529357	<b>Ref. No.</b>	753742
<b>description</b>	O-ring Viton thickness 3.53mm ID ø 23.4mm Qty 1 pcs		

**NBR**

1

Varenummer Varenummer	532735	<b>Ref. No.</b>	503932
<b>description</b>	O-ring NBR 70 thickness 1mm ID ø 6mm		

**sealing washers**

**copper gaskets**

DIN-7603-A

1

Varenummer Varenummer	528433	<b>Ref. No.</b>	097071 217840
<b>description</b>	flat gasket copper ED ø 14mm ID ø 10mm thickness 1mm		
<b>For models:</b>	390003, 397229, 397237, 397245, 397253, 397261, 397288, 397296, 397318, 397326, 397334, 397342, 397350, 397776, 397784, 397792, 397806, 397814, 397822, 397830, 397849, 397857, 397865, 397873, 398047, 398055, 398063, 398071, 398098, 398101, 398128, 398136, 398144, 398152, 399019, 399027, 399035, 399043, 399051, 399078, 399086, 399094, 399108, 399116, 606316, 606324, 606332, 606340, 606359, 606367...(Other models you can see in the webshop)		

DIN-7603-C

1

Varenummer Varenummer	510420	<b>Ref. No.</b>	002909
<b>description</b>	gasket copper ED ø 19.9mm ID ø 14.3mm thickness 2mm Qty 1 pcs		

**PTFE gaskets**

1

Varenummer Varenummer	518669	<b>Ref. No.</b>	373079
<b>description</b>	gasket PTFE ED ø 21mm ID ø 15mm thickness 3.5mm		
<b>accessories for</b>	518669		
	Varenummer Varenummer	375889	Ref. No. 504602
	safety thermostat switch-off temp. 360°C 1-pole 16A probe ø 15mm probe L 6.5mm capillary pipe 1140mm capillary pipe isolated 1100mm gland nut probe		

**silicone gaskets**

1

Varenummer Varenummer	359721	<b>Ref. No.</b>	316296 693421
<b>description</b>	gasket silicone ED ø 48mm ID ø 39.5mm thickness 5mm Qty 1 pcs		
<b>For models:</b>	Heissluftdaempfer-10x1-1, Heissluftdaempfer-5x1-1, Heissluftdaempfer-5x2-3		

**special gaskets**

for combi-steamers

1

Varenummer Varenummer	699472	<b>Ref. No.</b>	874833
<b>description</b>	gasket ignition electrode ID ø 13mm hole ø 6mm L 60mm W 22mm suitable for ELOMA graphite		

1

Varenummer Varenummer	699471	<b>Ref. No.</b>	874876
<b>description</b>	gasket suitable for ELOMA for model Genius T 6-11 10-11 for burner chamber L 108mm W 100mm graphite combi-steamer		

mechanical components, equipment accessories



1

Varenummer Varenummer	699470	Ref. No.	874841
<b>description</b>	gasket suitable for ELOMA for model Genius T 6-11 10-11 for radial fan L 65mm W 82mm for combi-steamer ID ø 25mm graphite thickness 1.7mm		

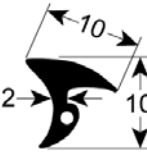

1

Varenummer Varenummer	560648	Ref. No.	584096
<b>description</b>	gasket suitable for ELOMA L 1000mm Qty 1m for combi-steamer		

thermostat gaskets



1

Varenummer Varenummer	518669	Ref. No.	373079
<b>description</b>	gasket PTFE ED ø 21mm ID ø 15mm thickness 3.5mm		
<b>accessories for</b>	518669		
	Varenummer Varenummer	375889	Ref. No. 504602
	safety thermostat switch-off temp. 360°C 1-pole 16A probe ø 15mm probe L 6.5mm capillary pipe 1140mm capillary pipe isolated 1100mm gland nut probe		

springs

torsion springs



1

Varenummer Varenummer	692523	Ref. No.	897531
<b>description</b>	torsion spring ø 27.8mm ID ø 21.7mm L2 44mm wire gauge ø 3mm L1 13mm L3 44mm Qty 1 pcs		



1



Varenummer Varenummer	692911	Ref. No.	791520
<b>description</b>	torsion spring ø 27mm wire gauge ø 2.3mm mounting pos. door handle L1 11mm Qty 1 pcs		

hose reels and spray guns

spray guns





1

Varenummer Varenummer	548636	Ref. No.	393002
<b>description</b>	spray gun 1/2" ET L 250mm		
<b>spare parts for</b>	548636		
	Varenummer Varenummer	540457	Ref. No. —
	pressure pin ø 10mm D1 ø 18mm L 48.7mm with spring for spray gun edition from 03/2016		
	Varenummer Varenummer	549970	Ref. No. —
	pressure pin ø 10mm D1 ø 18mm L 50.2mm with spring for spray gun		



1

Varenummer Varenummer	540301	Ref. No.	587583
<b>description</b>	spray gun for appliances 1/2" ET L 128mm		
<b>For models:</b>	671568, 671576, 671584, 671592, 671606, 671614, 671622, 671630, 671649, 671657, 671665, 671673, 671681, 671711, 671746, 671754, 671762, 671770, 671789, 671797, 671800, 671819, 671827, 671835, 671843, 671851, 671878, 671886, 671894, 671908, 671916, 671975, 671983, 671991, 680583, 680591, 754595, 754609, 754617, 754668, 754676, 754681, 754692, 754706, 754714, 754722, 754730, 754749, 754757, 754773...(Other models you can see in the webshop)		
<b>accessories for</b>	540301		
	Varenummer Varenummer	530922	Ref. No. 504696
	shower hose connections 1/2" L 800mm SS for combi-steamer		



1

Varenummer Varenummer	530922	Ref. No.	504696
<b>description</b>	shower hose connections 1/2" L 800mm SS for combi-steamer		
<b>accessories for</b>	530922		
	Varenummer Varenummer	540301	Ref. No. 587583
	spray gun for appliances 1/2" ET L 128mm		



hose reels

appliance hose reels



1

Varenummer Varenummer	545067	Ref. No.	753181
description	hose reel without spray gun hose length 1.55m		



1

Varenummer Varenummer	540480	Ref. No.	580953
description	hose reel without spray gun hose length 1.7m		

hoses

supply hoses

PVC supply hoses

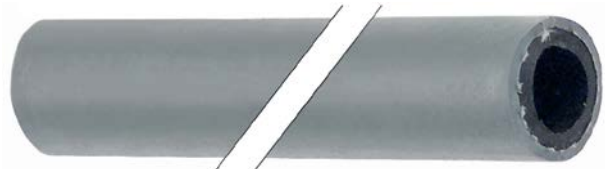

1

Varenummer Varenummer	520017	Ref. No.	040088
description	supply hose ID ø 13mm ED ø 20mm L 5m operating p. 20bar burst p. 60bar t.max. 95°C grey Qty 5m		
For models:	271500, 337xxx, 340022, 340030, 340049, 340057, 340073, 340xxx, 353167, 354392, 354457, 361763, 378933, 440078, 440086, 440094, 440655, 450111, Geschirrspuelautomat-330, Geschirrspuelautomat-335, Geschirrspuelautomat-336, Geschirrspuelautomat-700, GsP-350, GsP-500, GsP-600		

pre-rinse hoses

stainless steel spiral tubes



1

Varenummer Varenummer	530922	Ref. No.	504696
description	shower hose connections 1/2" L 800mm SS for combi-steamer		
accessories for	530922		
	Varenummer Varenummer	540301	Ref. No. 587583
	spray gun for appliances 1/2" ET L 128mm		

industrial hoses

nylon hoses



1

Varenummer Varenummer	520252	Ref. No.	785857
description	nylon hose ID ø 6mm ED ø 8mm L 5m thickness 1mm operating p. 10bar burst p. 50bar t.max. 100°C white		

silicone hoses

with fabric

with glass fibre sleeving



1

Varenummer Varenummer	520024	Ref. No.	253847 593303
description	silicone hose with glass fibre sleeving ID ø 9.5mm ED ø 17mm L 5m thickness 3.75mm operating p. 4bar burst pressure at 95°C 26bar burst pressure 130°C 14bar t.max. 200°C white		

fittings, hose and pipe connectors

hose connectors

miscellaneous



1

Varenummer Varenummer	501591	Ref. No.	753890
description	hose connector stainless steel hose ø 10/13mm M9 for cleaning system combi-steamer		

fittings

double nipples



1

Varenummer Varenummer	520160	Ref. No.	754447
description	double nipple nickel-plated brass thread 1/8" - 1/8" Qty 1 pcs		



1

Varenummer Varenummer	521187	Ref. No.	570451
<b>description</b>	double nipple nickel-plated brass thread 1/8" - 3/8" Qty 1 pcs int. ø 1.5mm int. ø 2.9.3mm		

### angle pieces



1

Varenummer Varenummer	520824	Ref. No.	773719
<b>description</b>	angle piece thread 1/8" ET - 1/8" IT nickel-plated brass		

## water cycle components

### pressure reduction valves

#### pressure reduction valves

##### producer-specific



1

Varenummer Varenummer	520502	Ref. No.	384437 577316 598198 874419
<b>description</b>	pressure reduction valve Norgren series R91 connection 1/8" default settingbar setting range 0.1-3bar p max 10bar t.max. 50°C brass		
<b>For models:</b>	367788, 382191, 385018, 385026, 385034, 385042, 385050, 385514, 389595, 389609, 390003, 397210, 397229, 397237, 397245, 397253, 397261, 397288, 397296, 397318, 397326, 397334, 397342, 397350, 397431, 397776, 397784, 397792, 397806, 397814, 397822, 397830, 397849, 397857, 397865, 397873, 398047, 398055, 398063, 398071, 398098, 398101, 398128, 398136, 398144, 398152, 398950, 398969, 398977, 399019...(Other models you can see in the webshop)		
<b>accessories for</b>	520502		
	Varenummer Varenummer	541979	Ref. No. —
	manometer ø 40mm pressure range 0-4bar connection at the rear in the centre thread 1/8"		
	Varenummer Varenummer	542449	Ref. No. —
	manometer ø 40mm pressure range 0-6bar connection at the rear in the centre thread 1/8"		

## ancillary products

### thread sealants



1

Varenummer Varenummer	890058	Ref. No.	593567
<b>description</b>	thread sealing LOCTITE 511 liquid bottle 50ml		
<b>description</b>	LOCTITE® 511™ - bottle 50ml It is designed for the locking and sealing of metal threaded pipes and fittings. The product cures rapidly when confined in the absence of air between close fitting metal surfaces.		

### clamps

#### security hose clamps

##### SS/brass



1

Varenummer Varenummer	520069	Ref. No.	276634
<b>description</b>	hose clamp SS/brass ø 14-19mm width 11mm Qty 5 pcs		



1

Varenummer Varenummer	520071	Ref. No.	276642 572160
<b>description</b>	hose clamp SS/brass ø 17-22mm width 11mm Qty 5 pcs		
<b>For models:</b>	340022, 340030, 340049, 340057, 340073, 353167, 354392, 354457, 361763, 378933, 398047, 398055, 398063, 398071, 398098, 398101, 398128, 398136, 398144, 398152, 440078, 440086, 440094, 440140, 440655, 450111, 609501, 609528, 609536, 671649, 671657, 671665, 671673, 671681, 671711, 671746, 671754, 671762, 671770, 671789, 671797, 671800, 671819, 671827, 671835, 671843, 671851, 671878, 671886, 671894...(Other models you can see in the webshop)		



1

Varenummer Varenummer	520067	Ref. No.	277665
<b>description</b>	hose clamp SS/brass ø 9-14mm width 10mm Qty 5 pcs		



# fastening material

## screws

### flat-headed bolts



Varenummer Varenummer	560491	Ref. No.	162469
<b>description</b>	flat-headed bolt thread M3 thread L 16mm stainless steel DIN 7985 Qty 20 pcs intake Phillips head ø 6mm head thickness 2.5mm		

### hexagonal screws



Varenummer Varenummer	560086	Ref. No.	251836
<b>description</b>	hexagonal screw thread M6 thread L 10mm SS WS 10 Qty 20 pcs DIN 933 / ISO 4017		

### grub screws

#### DIN 913/ISO 4026



Varenummer Varenummer	560497	Ref. No.	753785
<b>description</b>	grub screw thread M8 L 8mm A2-A2L DIN 913/ISO 4026 WS 4 Qty 20 pcs		

#### DIN 916/ISO 4029



Varenummer Varenummer	560173	Ref. No.	588512 895415
<b>description</b>	grub screw thread M4 L 10mm SS DIN 916/ISO 4029 intake internal hexagon WS 2 Qty 20 pcs		
<b>For models:</b>	671568, 671576, 671584, 671592, 671606, 671614, 671622, 671630, 758752, 758760, 758981, 759007, 759015, 759023, 759031, 759058, 759066, 759074, 759171, 759198		

### miscellaneous

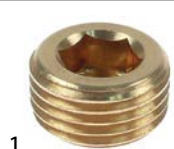

Varenummer Varenummer	560621	Ref. No.	399280
<b>description</b>	grub screw thread 1/8" L 5mm brass WS hexagonal 5mm Qty 1 pcs		

## nuts

### cap nuts



Varenummer Varenummer	560137	Ref. No.	057355
<b>description</b>	cap nuts thread M6 WS 10 SS Qty 20 pcs DIN/ISO DIN 1587		

### hexagonal nuts

#### DIN 934 / ISO 4032/8673



Varenummer Varenummer	560340	Ref. No.	003905
<b>description</b>	hexagonal nut thread M4 H 3.2mm WS 7 SS DIN/ISO DIN 934 / ISO 4032/8673 Qty 1 pcs		



Varenummer Varenummer	560133	Ref. No.	251887
<b>description</b>	hexagonal nut thread M6 H 5mm WS 10 SS DIN/ISO DIN 934 / ISO 4032/8673 Qty 20 pcs		
<b>For models:</b>	140902, 144819, 271500, 337xxx, 340022, 340030, 340049, 340057, 340073, 340xxx, 353167, 354392, 354457, 354643, 354651, 354678, 354686, 354694, 354708, 361429, 361437, 361763, 367788, 378933, 382191, 385018, 385026, 385034, 385042, 385050, 385514, 389595, 389609, 390003, 397210, 397229, 397237, 397245, 397253, 397261, 397288, 397296, 397318, 397326, 397334, 397342, 397350, 397431, 397776, 397784...(Other models you can see in the webshop)		

#### DIN 985



Varenummer Varenummer	560143	Ref. No.	587095
<b>description</b>	hexagonal nut thread M8 H 8.5mm SS WS 13 Qty 20 pcs DIN/ISO DIN 985 self-locking		

### hexagonal nuts metric (without norm)



Varenummer Varenummer	102067	Ref. No.	054240
<b>description</b>	nut thread M8x1 H 3mm brass Qty 1 pcs type SEF 1		
<b>For models:</b>	399701, 399728, 541419, 541427, 640018, 642053, 645005, 800163, 800171, 800198, 800201, 800228, 800236, 800244, 800252, 800260, 800279, 800287, 800295, Gas-Brater-641, Gas-Griddleplatte-642, Gasherd-645, Gasherd-64502, Gasherd-646, Gas-sudpfanne-643, Gas-Wurstgrill-640, Maxima-Gasherd-700-850, Maxima-Gasherd-neue-Ausfuehrung-700-850		

5 tools, fastening materials, consumables



washers

washers

DIN 9021



1

Varenummer Varenummer	560117	Ref. No.	000582
description	plain washer ID ø 6.4mm ED ø 18mm thickness 1.5mm SS Qty 20 pcs DIN 9021 for thread M6		
For models:	271500, 337xxx, 340022, 340030, 340049, 340057, 340073, 340xxx, 353167, 354392, 354457, 361763, 367788, 378933, 382191, 385018, 385026, 385034, 385042, 385050, 385514, 390003, 397210, 397229, 397237, 397245, 397253, 397261, 397288, 397296, 397318, 397326, 397334, 397342, 397350, 397431, 397776, 397784, 397792, 397806, 397814, 397822, 397830, 397849, 397857, 397865, 397873, 398047, 398055, 398063...(Other models you can see in the webshop)		

tooth lock washers

DIN 6798A



1

Varenummer Varenummer	560193	Ref. No.	349771
description	tooth lock washer ID ø 10.4mm ED ø 18mm zinc-coated steel DIN/ ISO DIN 6798A Qty 1 pcs for thread M10		



1

Varenummer Varenummer	560127	Ref. No.	006777 892912
description	tooth lock washer ID ø 6.2mm ED ø 11mm SS DIN/ISO DIN 6798A Qty 20 pcs for thread M6		
For models:	140902, 144819, 271500, 337xxx, 340022, 340030, 340049, 340057, 340073, 340xxx, 353167, 354392, 354457, 361763, 367788, 378933, 382191, 385018, 385026, 385034, 385042, 385050, 385514, 389595, 389609, 390003, 397210, 397229, 397237, 397245, 397253, 397261, 397288, 397296, 397318, 397326, 397334, 397342, 397350, 397431, 397776, 397784, 397792, 397806, 397814, 397822, 397830, 397849, 397857, 397865...(Other models you can see in the webshop)		

fasteners

slot nuts



1

Varenummer Varenummer	694995	Ref. No.	760978
description	slot nut W 4mm H 5mm L 12mm half-round for door latch DIN 6888		

clamps

security hose clamps

SS/brass



1

Varenummer Varenummer	520069	Ref. No.	276634
description	hose clamp SS/brass ø 14-19mm width 11mm Qty 5 pcs		



1

Varenummer Varenummer	520071	Ref. No.	276642 572160
description	hose clamp SS/brass ø 17-22mm width 11mm Qty 5 pcs		
For models:	340022, 340030, 340049, 340057, 340073, 353167, 354392, 354457, 361763, 378933, 398047, 398055, 398063, 398071, 398098, 398101, 398128, 398136, 398144, 398152, 440078, 440086, 440094, 440140, 440655, 450111, 609501, 609528, 609536, 671649, 671657, 671665, 671673, 671681, 671711, 671746, 671754, 671762, 671770, 671789, 671797, 671800, 671819, 671827, 671835, 671843, 671851, 671878, 671886, 671894...(Other models you can see in the webshop)		



1

Varenummer Varenummer	520067	Ref. No.	277665
description	hose clamp SS/brass ø 9-14mm width 10mm Qty 5 pcs		

consumables

sealants and adhesives

thread sealants



1

Varenummer Varenummer	890058	Ref. No.	593567
description	thread sealing LOCTITE 511 liquid bottle 50ml		
description	LOCTITE® 511™ - bottle 50ml It is designed for the locking and sealing of metal threaded pipes and fittings. The product cures rapidly when confined in the absence of air between close fitting metal surfaces.		



fuses

fine fuses



1

Varenummer Varenummer	358532	<b>Ref. No.</b>	190756
<b>description</b>	fine fuse size $\phi$ 5x20mm 2A fast-acting rated 250V Qty 10 pcs		



1

Varenummer Varenummer	358608	<b>Ref. No.</b>	578975
<b>description</b>	fine fuse size $\phi$ 5x20mm 10A slow-acting rated 250V Qty 10 pcs		

fine fuse holders



1

Varenummer Varenummer	358049	<b>Ref. No.</b>	751847
<b>description</b>	fuse holder		

screw locks

D0-system (NEOZED)



1

Varenummer Varenummer	358043	<b>Ref. No.</b>	658294
<b>description</b>	fuse size D01 16A rated 250/400V E14 $\phi$ 11mm L 36mm Qty 10 pcs		



1

Varenummer Varenummer	358045	<b>Ref. No.</b>	751863
<b>description</b>	fuse size D02 35A rated 250/400V E18 $\phi$ 15mm L 36mm Qty 10 pcs		



1

Varenummer Varenummer	358046	<b>Ref. No.</b>	658286
<b>description</b>	fuse size D02 50A rated 250/400V E18 $\phi$ 15mm L 36mm Qty 10 pcs		

gauge pieces (NEOZED)



1

Varenummer Varenummer	358067	<b>Ref. No.</b>	751855
<b>description</b>	gauge piece size D02 suitable for 35A		



1

Varenummer Varenummer	358068	<b>Ref. No.</b>	658278
<b>description</b>	gauge piece size D02 suitable for 50A		



<b>A</b>			
alarm devices	15	heating elements for convection	2
appliance hose reels	39	hexagonal nuts	41
audible timers	15	hexagonal screws	41
axial fans	22	hose connectors	39
		hose reels	39
<b>C</b>		hoses	39
cam switches	9	hot air motors	22
cap nuts	41		
castors and bumper angles	34	<b>I</b>	
clamps	40, 42	ignition boxes	26
condensators & interference suppression filters	24	indicator lights	11
consumables	42	indicator lights (complete)	11
contactors	15	industrial hoses	39
control equipment	10	infrared lamps	13
control thermostats	5, 7		
		<b>L</b>	
<b>D</b>		lamps	11
door catches	33	light bulbs	12
door seals	34	linear lamps	13
double nipples	39		
		<b>M</b>	
<b>E</b>		magnetic switches	10
edgemount hinges	33	microswitches	8
edgemount latches	33		
electric accessories	25	<b>N</b>	
electric timers	14	neon light bulbs	11, 12
electronic controllers	18	nuts	41
energy regulators	4	nylon hoses	39
<b>F</b>		<b>O</b>	
fans	22	operating capacitors	24
fasteners	42	O-rings	36
fastening material	41	oven lamps	13
fine fuses	43		
fittings	39	<b>P</b>	
flat-headed bolts	41	pilot burners	26
fuses	24, 43	pilot heating elements	2
		pre-rinse hoses	39
<b>G</b>		pressure reduction valves	40, 40
gas control valves	25	pressure switches	21
gas nozzles	29	probes	18
gaskets for control panels	36	pumps	24
gaskets for heated units	34	push/momentary push switches	7
gaskets for tray rack trolleys	36	PVC supply hoses	39
GEV	2		
grub screws	41	<b>R</b>	
		radial fans	24
<b>H</b>		relays	17
halogen lamp	12	residual heat indicators	14
handle latches	33	rocker/momentary rocker switches	7
heating elements	2		
		<b>S</b>	
		safety thermostats	5

screw locks	43
screws	41
sealants and adhesives	42
sealing washers	37
security hose clamps	40, 42
silicone hoses	39
slot nuts	42
solenoid valves	19
solid state relays	16
spray guns	38
spray guns with external thread	38
stainless steel spiral tubes	39
supply hoses	39
switches and momentary switches	7

**T**

terminals	25
thermocouples	28
thermostat gaskets	38
thermostats	5
thread sealants	29, 40, 42
time relays	17
timers	14
tooth lock washers	42
transformers	17

**V**

vibration pumps	24
-----------------	----

**W**

washers	42
water cycle components	40
window seals	34