



pumps

wash and rinse pumps

OLYMPIA

pumps



1

Vare nr.	500521	Ref. No.	T33
description	pump inlet \varnothing 1" IT outlet \varnothing 26mm type T33 230V 50Hz 1 phase 0,25kW 0,34HP L 225mm rotation direction right capacitor 5 μ F auxiliary pressure connection 11mm supporting pressure closed OLYMPIA		
spare parts for	500521		
	Vare nr.	365017	Ref. No. —
	operating capacitor capacity 5 μ F 450V		
	Vare nr.	510693	Ref. No. N/A
	mechanical shaft seal for shaft \varnothing 12 mm		
	Vare nr.	521256	Ref. No. N/A
	impellor \varnothing 74 mm H 14 mm thread M10L shaft \varnothing 12 mm		
	Vare nr.	521554	Ref. No. N/A
	pump cover OLYMPIA inlet 1" \varnothing 90 mm ID \varnothing 66 mm		
	Vare nr.	521724	Ref. No. N/A
	O-ring EPDM thickness 1,78 mm ID \varnothing 72,75 mm		
	Vare nr.	528800	Ref. No. N/A
	O-ring EPDM thickness 2,62 mm ID \varnothing 75,87 mm		



1

Vare nr.	500005	Ref. No.	T60
description	pump inlet \varnothing 1" IT outlet \varnothing 28mm type T60 230V 50Hz 1 phase 0,19kW 0,26HP L 210mm rotation direction left capacitor 5 μ F OLYMPIA		
spare parts for	500005		
	Vare nr.	365017	Ref. No. —
	operating capacitor capacity 5 μ F 450V		
	Vare nr.	509001	Ref. No. N/A
	impellor \varnothing 75 mm H 15 mm pump type type C		
	Vare nr.	509003	Ref. No. N/A
	pump cover OLYMPIA inlet 1" outlet \varnothing 28 mm		
	Vare nr.	510693	Ref. No. N/A
	mechanical shaft seal for shaft \varnothing 12 mm		
	Vare nr.	528800	Ref. No. N/A
	O-ring EPDM thickness 2,62 mm ID \varnothing 75,87 mm		



1











Vare nr.	499257	Ref. No.	T.45
description	pump inlet \varnothing 1" IT outlet \varnothing 30mm type L63.T45F_2V 230V 50Hz 1 phase 0,33kW L 230mm rotation direction left capacitor 8 μ F OLYMPIA		
spare parts for	499257		
	Vare nr.	365013	Ref. No. —
	operating capacitor capacity 8 μ F 400V		
	Vare nr.	509007	Ref. No. N/A
	impellor \varnothing 85 mm H 20 mm rotation direction left		





Table continues overleaf

spare parts for 499257			
	Vare nr.	510693	Ref. No. N/A
mechanical shaft seal for shaft \varnothing 12 mm			
	Vare nr.	521167	Ref. No. N/A
pump cover OLYMPIA inlet \varnothing 1"mm outlet \varnothing 30/30mm			
	Vare nr.	521723	Ref. No. N/A
pump cover gasket EPDM thickness 2 mm ID \varnothing 90 mm			



Vare nr.	499131	Ref. No.	T.19DX
description	pump inlet \varnothing 1" IT outlet \varnothing 30mm type T.19DX 230V 50Hz 1 phase 0,19kW L 195mm rotation direction left capacitor 5 μ F OLYMPIA outlet \varnothing 30mm		
spare parts for 499131			
	Vare nr.	365017	Ref. No. —
operating capacitor capacity 5 μ F 450V			
	Vare nr.	510693	Ref. No. N/A
mechanical shaft seal for shaft \varnothing 12 mm			
	Vare nr.	521168	Ref. No. N/A
pump cover OLYMPIA inlet \varnothing 1"mm outlet \varnothing 30 mm			
	Vare nr.	521169	Ref. No. N/A
impeller \varnothing 64 mm H 15 mm pump type T.19DX			
	Vare nr.	521723	Ref. No. N/A
pump cover gasket EPDM thickness 2 mm ID \varnothing 90 mm			



Vare nr.	499258	Ref. No.	R63.T33 PRS
description	pump inlet \varnothing 15mm outlet \varnothing 13mm type R63.T33 PRS 400V 50Hz 3 phase 0,25kW L 185mm rotation direction left OLYMPIA		
spare parts for 499258			
	Vare nr.	510693	Ref. No. N/A
mechanical shaft seal for shaft \varnothing 12 mm			
	Vare nr.	521165	Ref. No. N/A
pump cover OLYMPIA inlet \varnothing 15 mm outlet \varnothing 13 mm			
	Vare nr.	521166	Ref. No. N/A
impeller \varnothing 90 mm H 9 mm pump type R63.T33 PRS			
	Vare nr.	525022	Ref. No. N/A
O-ring EPDM thickness 1,78mm ID \varnothing 75,92mm			













Vare nr.	499095	Ref. No.	T.33PRS
description	pump inlet \varnothing 15mm outlet \varnothing 14mm type T.33PRS 230V 50Hz 1 phase 0,25kW L 185mm rotation direction right capacitor 8 μ F OLYMPIA		
spare parts for 499095			
	Vare nr.	365013	Ref. No. —
operating capacitor capacity 8 μ F 400V			
	Vare nr.	510693	Ref. No. N/A
mechanical shaft seal for shaft \varnothing 12 mm			
	Vare nr.	521165	Ref. No. N/A
pump cover OLYMPIA inlet \varnothing 15 mm outlet \varnothing 13 mm			

Table continues overleaf

spare parts for 499095			
	Vare nr.	521166	Ref. No. N/A
impellor ø 90 mm H 9 mm pump type R63.T33 PRS			
	Vare nr.	525022	Ref. No. N/A
O-ring EPDM thickness 1,78mm ID ø 75,92mm			



1		
Vare nr.	499318	Ref. No. L63.T19
description	pump inlet ø 28mm outlet ø 28mm type L63.T19 230V 50Hz 1 phase 0,19kW L 185mm rotation direction right capacitor 5µF OLYMPIA inlet ø 28mm outlet ø 28mm	
spare parts for 499318		
	Vare nr.	365017 Ref. No. —
operating capacitor capacity 5µF 450V		
	Vare nr.	510693 Ref. No. N/A
mechanical shaft seal for shaft ø 12 mm		
	Vare nr.	521163 Ref. No. N/A
pump cover OLYMPIA inlet ø 28 mm outlet ø 26 mm		
	Vare nr.	521164 Ref. No. N/A
impellor ø 64 mm H 15 mm pump type L63.T19		
	Vare nr.	521724 Ref. No. N/A
O-ring EPDM thickness 1,78 mm ID ø 72,75 mm		



1		
Vare nr.	500957	Ref. No. T.25 Olympia
description	pump inlet ø 28mm outlet ø 28mm type T25 230V 50Hz 1 phase 0,19kW 0,25HP L 190mm rotation direction left capacitor 6,3µF OLYMPIA	
spare parts for 500957		
	Vare nr.	365012 Ref. No. —
operating capacitor capacity 6,3µF 450V		
	Vare nr.	510248 Ref. No. N/A
pump cover OLYMPIA inlet ø 28 mm outlet ø 28 mm		
	Vare nr.	510249 Ref. No. N/A
impellor ø 74 mm H 19 mm pump type T25		
	Vare nr.	510693 Ref. No. N/A
mechanical shaft seal for shaft ø 12 mm		
	Vare nr.	528800 Ref. No. N/A
O-ring EPDM thickness 2,62 mm ID ø 75,87 mm		









1		
Vare nr.	499229	Ref. No. L63.T19
description	pump inlet ø 28mm outlet ø 30mm type L63.T19 230V 50Hz 1 phase 0,19kW L 215mm rotation direction right capacitor 5µF OLYMPIA	
spare parts for 499229		
	Vare nr.	365017 Ref. No. —
operating capacitor capacity 5µF 450V		
	Vare nr.	510693 Ref. No. N/A
mechanical shaft seal for shaft ø 12 mm		

Table continues overleaf

spare parts for 499229			
	Vare nr.	521164	Ref. No. N/A
impellor ø 64 mm H 15 mm pump type L63.T19			
	Vare nr.	521170	Ref. No. N/A
pump cover OLYMPIA outlet ø 30 mm			
	Vare nr.	521724	Ref. No. N/A
O-ring EPDM thickness 1,78 mm ID ø 72,75 mm			



1

Vare nr.	499256	Ref. No.	L63.T40
description	pump inlet ø 28mm outlet ø 30mm type L63.T40 230V 50Hz 1 phase 0,4kW L 235mm rotation direction right capacitor 5µF OLYMPIA		
spare parts for 499256			
	Vare nr.	365017	Ref. No. —
operating capacitor capacity 5µF 450V			
	Vare nr.	510693	Ref. No. N/A
mechanical shaft seal for shaft ø 12 mm			
	Vare nr.	521170	Ref. No. N/A
pump cover OLYMPIA outlet ø 30 mm			
	Vare nr.	521171	Ref. No. N/A
impellor ø 74 mm H 16 mm pump type L63.T40			
	Vare nr.	521724	Ref. No. N/A
O-ring EPDM thickness 1,78 mm ID ø 72,75 mm			



1

Vare nr.	500522	Ref. No.	T41
description	pump inlet ø 29mm outlet ø 27mm type T41 230V 50Hz 1 phase 0,29kW 0,4HP L 200mm rotation direction left capacitor 8µF OLYMPIA		
spare parts for 500522			
	Vare nr.	365013	Ref. No. —
operating capacitor capacity 8µF 400V			
	Vare nr.	510693	Ref. No. N/A
mechanical shaft seal for shaft ø 12 mm			
	Vare nr.	521259	Ref. No. N/A
impellor ø 94 mm H 11 mm rotation direction left			
	Vare nr.	521555	Ref. No. N/A
pump cover OLYMPIA inlet ø 29 mm outlet ø 28 mm			
	Vare nr.	521726	Ref. No. N/A
pump cover gasket EPDM thickness 2 mm ID ø 120 mm			



1





Vare nr.	500000	Ref. No.	T4
description	pump inlet ø 29mm outlet ø 28mm type T 4 230V 50Hz 1 phase 0,29kW 0,39HP L 202mm rotation direction left capacitor 8µF OLYMPIA		
spare parts for 500000			
	Vare nr.	365013	Ref. No. —
operating capacitor capacity 8µF 400V			
	Vare nr.	510554	Ref. No. N/A
O-ring EPDM thickness 2 mm ID ø 120 mm Qty 1 pcs			





Table continues overleaf

spare parts for 500000			
	Vare nr. 510693	Ref. No.	N/A
mechanical shaft seal for shaft ø 12 mm			
	Vare nr. 521176	Ref. No.	N/A
pump cover OLYMPIA inlet ø 1"mm outlet ø 28 mm			
	Vare nr. 521257	Ref. No.	—
impellor ø 80 mm H 12 mm rotation direction left			



1			
Vare nr.	499296	Ref. No.	L71.T730_30 (590046)
description	pump inlet ø 30mm outlet ø 30mm type L71.T730_30 230V 50Hz 1 phase 0,52kW L 230mm rotation direction right capacitor 12,5µF OLYMPIA		
spare parts for 499296			
	Vare nr. 365014	Ref. No.	—
operating capacitor capacity 12,5µF 400V			
	Vare nr. 510554	Ref. No.	N/A
O-ring EPDM thickness 2 mm ID ø 120 mm Qty 1 pcs			
	Vare nr. 510693	Ref. No.	N/A
mechanical shaft seal for shaft ø 12 mm			
	Vare nr. 521159	Ref. No.	N/A
pump cover OLYMPIA inlet 30 inlet ø 30 mm			
	Vare nr. 521160	Ref. No.	N/A
impellor ø 97 mm H 22 mm thread M10L			



1			
Vare nr.	499295	Ref. No.	L71.T730_30 (590108)
description	pump inlet ø 30mm outlet ø 30mm type L71.T730_30 230V 50Hz 1 phase 0,52kW L 230mm rotation direction right capacitor 12,5µF OLYMPIA inlet ø 30mm outlet ø 30mm		
spare parts for 499295			
	Vare nr. 365014	Ref. No.	—
operating capacitor capacity 12,5µF 400V			
	Vare nr. 510554	Ref. No.	N/A
O-ring EPDM thickness 2 mm ID ø 120 mm Qty 1 pcs			
	Vare nr. 510693	Ref. No.	N/A
mechanical shaft seal for shaft ø 12 mm			
	Vare nr. 521159	Ref. No.	N/A
pump cover OLYMPIA inlet 30 inlet ø 30 mm			
	Vare nr. 521160	Ref. No.	N/A
impellor ø 97 mm H 22 mm thread M10L			



1

Vare nr.	500199	Ref. No.	T80
description	pump inlet ø 32mm outlet ø 30/24mm type T80 230V 50Hz 1 phase 0,25kW 0,34HP L 205mm rotation direction left capacitor 5µF OLYMPIA		
spare parts for	500199		
	Vare nr.	365017	Ref. No. —
	operating capacitor capacity 5µF 450V		
	Vare nr.	510693	Ref. No. N/A
	mechanical shaft seal for shaft ø 12 mm		
	Vare nr.	521151	Ref. No. N/A
	impellor ø 71 mm H 19 mm pump type OLYMPIA		
	Vare nr.	521178	Ref. No. N/A
	pump casing OLYMPIA outlet ø 30/24mm pump type T80		
	Vare nr.	521552	Ref. No. N/A
	pump cover OLYMPIA inlet ø 32 mm outlet ø 30/24mm		
	Vare nr.	521703	Ref. No. N/A
	pump cover gasket EPDM thickness 2,5 mm ID ø 75 mm		



1



Vare nr.	499322	Ref. No.	L63.T33DX
description	pump inlet ø 33mm outlet ø 30/28mm type L63.T33DX 230V 50Hz 1 phase 0,26kW 0,33HP L 260mm rotation direction left capacitor 5µF OLYMPIA		
spare parts for	499322		
	Vare nr.	365017	Ref. No. —
	operating capacitor capacity 5µF 450V		
	Vare nr.	510693	Ref. No. N/A
	mechanical shaft seal for shaft ø 12 mm		
	Vare nr.	521258	Ref. No. N/A
	impellor ø 80 mm H 13 mm thread M10R shaft ø 12 mm		
	Vare nr.	521551	Ref. No. N/A
	pump cover OLYMPIA inlet ø 33 mm outlet ø 30 mm		
	Vare nr.	521723	Ref. No. N/A
	pump cover gasket EPDM thickness 2 mm ID ø 90 mm		







1

Vare nr.	500520	Ref. No.	T33
description	pump inlet ø 33mm outlet ø 30/28mm type T33 230V 50Hz 1 phase 0,25kW 0,34HP L 190mm rotation direction left capacitor 5µF OLYMPIA		
spare parts for	500520		
	Vare nr.	365017	Ref. No. —
	operating capacitor capacity 5µF 450V		
	Vare nr.	510693	Ref. No. N/A
	mechanical shaft seal for shaft ø 12 mm		





Table continues overleaf

spare parts for 500520			
	Vare nr. 521151	Ref. No.	N/A
impellor ø 71 mm H 19 mm pump type OLYMPIA			
	Vare nr. 521551	Ref. No.	N/A
pump cover OLYMPIA inlet ø 33 mm outlet ø 30 mm			
	Vare nr. 521723	Ref. No.	N/A
pump cover gasket EPDM thickness 2 mm ID ø 90 mm			



1			
Vare nr.	500958	Ref. No.	T.45 Krupps
description	pump inlet ø 33mm outlet ø 30/28mm type T45 230V 50Hz 1 phase 0,33kW 0,45HP L 215mm rotation direction left capacitor 8µF OLYMPIA		
spare parts for 500958			
	Vare nr. 365013	Ref. No.	—
operating capacitor capacity 8µF 400V			
	Vare nr. 510693	Ref. No.	N/A
mechanical shaft seal for shaft ø 12 mm			
	Vare nr. 521257	Ref. No.	—
impellor ø 80 mm H 12 mm rotation direction left			
	Vare nr. 521551	Ref. No.	N/A
pump cover OLYMPIA inlet ø 33 mm outlet ø 30 mm			
	Vare nr. 521723	Ref. No.	N/A
pump cover gasket EPDM thickness 2 mm ID ø 90 mm			



1			
Vare nr.	499320	Ref. No.	L63.T20SX
description	pump inlet ø 33mm outlet ø 30mm type L63.T20SX 230V 50Hz 1 phase 0,2kW L 200mm rotation direction right capacitor 5µF auxiliary pressure connection 10mm supporting pressure closed OLYMPIA		
spare parts for 499320			
	Vare nr. 365017	Ref. No.	—
operating capacitor capacity 5µF 450V			
	Vare nr. 510693	Ref. No.	N/A
mechanical shaft seal for shaft ø 12 mm			
	Vare nr. 521173	Ref. No.	N/A
pump cover OLYMPIA inlet ø 33 mm outlet ø 30 mm			
	Vare nr. 521174	Ref. No.	N/A
impellor ø 60 mm H 16 mm pump type L63.T20SX			
	Vare nr. 521723	Ref. No.	N/A
pump cover gasket EPDM thickness 2 mm ID ø 90 mm			













1			
Vare nr.	500519	Ref. No.	T33
description	pump inlet ø 33mm outlet ø 30mm type T33 230V 50Hz 1 phase 0,25kW 0,34HP L 195mm rotation direction left capacitor 5µF OLYMPIA		
spare parts for 500519			
	Vare nr. 365017	Ref. No.	—
operating capacitor capacity 5µF 450V			

Table continues overleaf



spare parts for 500519			
Vare nr.	510693	Ref. No.	N/A
	mechanical shaft seal for shaft \varnothing 12 mm		
Vare nr.	521257	Ref. No.	—
	impellor \varnothing 80 mm H 12 mm rotation direction left		
Vare nr.	521553	Ref. No.	N/A
	pump cover OLYMPIA inlet \varnothing 33 mm outlet \varnothing 30 mm		
Vare nr.	521723	Ref. No.	N/A
	pump cover gasket EPDM thickness 2 mm ID \varnothing 90 mm		





1			
Vare nr.	500152	Ref. No.	T90
description	pump inlet \varnothing 44mm outlet \varnothing 30mm type T90 230V 50Hz 1 phase 0,33kW 0,45HP L 220mm rotation direction left capacitor 8 μ F OLYMPIA		
spare parts for 500152			
	Vare nr. 365013	Ref. No.	—
operating capacitor capacity 8 μ F 400V			
	Vare nr. 509007	Ref. No.	N/A
impellor \varnothing 85 mm H 20 mm rotation direction left			
	Vare nr. 510693	Ref. No.	N/A
mechanical shaft seal for shaft \varnothing 12 mm			
	Vare nr. 521550	Ref. No.	N/A
pump cover OLYMPIA inlet \varnothing 44 mm			
	Vare nr. 521703	Ref. No.	N/A
pump cover gasket EPDM thickness 2,5 mm ID \varnothing 75 mm			



1			
Vare nr.	500003	Ref. No.	T30
description	pump inlet \varnothing 45mm outlet \varnothing 32mm type T30 230V 50Hz 1 phase 0,29kW 0,39HP L 190mm rotation direction right capacitor 8 μ F OLYMPIA		
spare parts for 500003			
	Vare nr. 365013	Ref. No.	—
operating capacitor capacity 8 μ F 400V			
	Vare nr. 510512	Ref. No.	N/A
pump cover OLYMPIA inlet \varnothing 45 mm outlet \varnothing 31 mm			
	Vare nr. 510554	Ref. No.	N/A
O-ring EPDM thickness 2 mm ID \varnothing 120 mm Qty 1 pcs			
	Vare nr. 510615	Ref. No.	N/A
impellor \varnothing 90 mm H 22 mm rotation direction right			
	Vare nr. 510693	Ref. No.	N/A
mechanical shaft seal for shaft \varnothing 12 mm			







1			
Vare nr.	499208	Ref. No.	L80.T100_4540
description	pump inlet ø 45mm outlet ø 40mm type L80.T100 230V 50Hz 1 phase 0,75kW 1HP L 210mm rotation direction right capacitor 12,5µF OLYMPIA		
spare parts for 499208			
	Vare nr.	365014	Ref. No. —
	operating capacitor capacity 12,5µF 400V		
	Vare nr.	510693	Ref. No. N/A
	mechanical shaft seal for shaft ø 12 mm		



1			
Vare nr.	499050	Ref. No.	MEC71.T75SX
description	pump inlet ø 45mm outlet ø 40mm type MEC71.T75SX 230V 50Hz 1 phase 0,55kW 0,75HP L 283mm rotation direction right capacitor 12,5µF OLYMPIA		
spare parts for 499050			
	Vare nr.	365014	Ref. No. —
	operating capacitor capacity 12,5µF 400V		
	Vare nr.	510554	Ref. No. N/A
	O-ring EPDM thickness 2 mm ID ø 120 mm Qty 1 pcs		
	Vare nr.	510693	Ref. No. N/A
	mechanical shaft seal for shaft ø 12 mm		
	Vare nr.	517368	Ref. No. N/A
	impellor ø 102 mm H 21 mm rotation direction right		

spare parts for 499050			
	Vare nr.	521158	Ref. No. N/A
	pump cover OLYMPIA inlet 45 inlet ø 40 mm		



1			
Vare nr.	500476	Ref. No.	T45
description	pump inlet ø 50mm outlet ø 30mm type T45 230V 50Hz 1 phase 0,33kW 0,45HP L 215mm rotation direction left capacitor 8µF OLYMPIA		
spare parts for 500476			
	Vare nr.	365013	Ref. No. —
	operating capacitor capacity 8µF 400V		
	Vare nr.	501312	Ref. No. —
	O-ring EPDM thickness 1,78 mm ID ø 88,62 mm		
	Vare nr.	510693	Ref. No. N/A
	mechanical shaft seal for shaft ø 12 mm		
	Vare nr.	521258	Ref. No. N/A
	impellor ø 80 mm H 13 mm thread M10R shaft ø 12 mm		







1			
Vare nr.	500523	Ref. No.	T5
description	pump inlet ø 50mm outlet ø 30mm type T5 230V 50Hz 1 phase 0,35kW 0,48HP L 205mm rotation direction right capacitor 10µF auxiliary pressure connection 10mm supporting pressure open OLYMPIA		
spare parts for 500523			
	Vare nr.	365015	Ref. No. —
	operating capacitor capacity 10µF 400V		

Table continues overleaf

spare parts for 500523			
	Vare nr.	510554	Ref. No. N/A
O-ring EPDM thickness 2 mm ID ø 120 mm Qty 1 pcs			
	Vare nr.	510693	Ref. No. N/A
mechanical shaft seal for shaft ø 12 mm			
	Vare nr.	521260	Ref. No. N/A
impellor ø 90 mm H 12 mm M10L type B			
	Vare nr.	521556	Ref. No. N/A
pump cover OLYMPIA inlet ø 50 mm outlet ø 30 mm			







1			
Vare nr.	500524	Ref. No.	T6
description	pump inlet ø 50mm outlet ø 30mm type T6 230V 50Hz 1 phase 0,48kW 0,65HP L 215mm rotation direction right capacitor 10µF OLYMPIA		
spare parts for 500524			
	Vare nr.	365015	Ref. No. —
operating capacitor capacity 10µF 400V			
	Vare nr.	510554	Ref. No. N/A
O-ring EPDM thickness 2 mm ID ø 120 mm Qty 1 pcs			
	Vare nr.	510693	Ref. No. N/A
mechanical shaft seal for shaft ø 12 mm			
	Vare nr.	521262	Ref. No. N/A
impellor ø 102 mm H 19 mm rotation direction right			
	Vare nr.	521556	Ref. No. N/A
pump cover OLYMPIA inlet ø 50 mm outlet ø 30 mm			



1			
Vare nr.	500525	Ref. No.	T7
description	pump inlet ø 50mm outlet ø 30mm type T7 230V 50Hz 1 phase 0,52kW 0,71HP L 230mm rotation direction right capacitor 12,5µF OLYMPIA		
spare parts for 500525			
	Vare nr.	365014	Ref. No. —
operating capacitor capacity 12,5µF 400V			
	Vare nr.	510554	Ref. No. N/A
O-ring EPDM thickness 2 mm ID ø 120 mm Qty 1 pcs			
	Vare nr.	510693	Ref. No. N/A
mechanical shaft seal for shaft ø 12 mm			
	Vare nr.	517368	Ref. No. N/A
impellor ø 102 mm H 21 mm rotation direction right			
	Vare nr.	521556	Ref. No. N/A
pump cover OLYMPIA inlet ø 50 mm outlet ø 30 mm			



1





Vare nr.	500983	Ref. No.	T7
description	pump inlet ø 50mm outlet ø 30mm type T7 230V 50Hz 1 phase 0,52kW 0,7HP L 220mm rotation direction right capacitor 10µF OLYMPIA		
spare parts for	500983		
	Vare nr.	365015	Ref. No. —
	operating capacitor capacity 10µF 400V		
	Vare nr.	510554	Ref. No. N/A
	O-ring EPDM thickness 2 mm ID ø 120 mm Qty 1 pcs		
	Vare nr.	510693	Ref. No. N/A
	mechanical shaft seal for shaft ø 12 mm		
	Vare nr.	517368	Ref. No. N/A
	impellor ø 102 mm H 21 mm rotation direction right		
	Vare nr.	521569	Ref. No. N/A
	pump cover OLYMPIA inlet ø 50 mm outlet ø 31 mm		



1





Vare nr.	499217	Ref. No.	L80.T7_5040
description	pump inlet ø 50mm outlet ø 40mm type L80.T7_5040 230V 50Hz 1 phase 0,6kW 0,8HP L 205mm rotation direction right capacitor 12,5µF D 85 dgt OLYMPIA		
spare parts for	499217		
	Vare nr.	365014	Ref. No. —
	operating capacitor capacity 12,5µF 400V		

spare parts for 499217

	Vare nr.	510554	Ref. No.	N/A
	O-ring EPDM thickness 2 mm ID ø 120 mm Qty 1 pcs			
	Vare nr.	510693	Ref. No.	N/A
	mechanical shaft seal for shaft ø 12 mm			
	Vare nr.	517368	Ref. No.	N/A
	impellor ø 102 mm H 21 mm rotation direction right			
	Vare nr.	521156	Ref. No.	N/A
	pump cover OLYMPIA inlet ø 50 mm outlet ø 40 mm			



1

Vare nr.	500477	Ref. No.	T5
description	pump inlet ø 50mm outlet ø 40mm type T5 230V 50Hz 1 phase 0,35kW 0,48HP L 200mm rotation direction right capacitor 10µF OLYMPIA inlet ø 50mm outlet ø 40mm		
spare parts for	500477		
	Vare nr.	365015	Ref. No. —
	operating capacitor capacity 10µF 400V		
	Vare nr.	507458	Ref. No. —
	impellor ø 90 mm H 12 mm rotation direction right		
	Vare nr.	510554	Ref. No. N/A
	O-ring EPDM thickness 2 mm ID ø 120 mm Qty 1 pcs		
	Vare nr.	510693	Ref. No. N/A
	mechanical shaft seal for shaft ø 12 mm		



1

Vare nr.	499314	Ref. No.	L71.T5_5040
----------	--------	----------	-------------

description pump inlet ø 50mm outlet ø 41mm type L71T5_5040 230V 50Hz 1 phase 0,38kW L 200mm rotation direction right capacitor 10µF OLYMPIA

spare parts for 499314

	Vare nr.	365015	Ref. No.	—
				operating capacitor capacity 10µF 400V
	Vare nr.	510554	Ref. No.	N/A
				O-ring EPDM thickness 2 mm ID ø 120 mm Qty 1 pcs
	Vare nr.	510693	Ref. No.	N/A
				mechanical shaft seal for shaft ø 12 mm
	Vare nr.	521156	Ref. No.	N/A
				pump cover OLYMPIA inlet ø 50 mm outlet ø 40 mm
	Vare nr.	521157	Ref. No.	N/A
				impellor ø 82 mm H 22 mm thread M10L



1

Vare nr.	499063	Ref. No.	T15
----------	--------	----------	-----

description pump inlet ø 50mm outlet ø 48mm type T15 230V 50Hz 1 phase 1,1kW L 295mm rotation direction right capacitor 16µF auxiliary pressure connection 10mm supporting pressure closed OLYMPIA

spare parts for 499063

	Vare nr.	365021	Ref. No.	—
				operating capacitor capacity 16µF 425V

spare parts for 499063

	Vare nr.	510693	Ref. No.	N/A
				mechanical shaft seal for shaft ø 12 mm
	Vare nr.	521065	Ref. No.	N/A
				pump cover OLYMPIA inlet ø 50 mm outlet ø 48 mm
	Vare nr.	521162	Ref. No.	N/A
				impellor ø 106 mm H 22 mm pump type T75
	Vare nr.	521727	Ref. No.	N/A
				pump cover gasket EPDM thickness 1,78 mm



1

Vare nr.	500475	Ref. No.	T75
----------	--------	----------	-----





description pump inlet ø 50mm outlet ø 48mm type T75 230V 50Hz 1 phase 0,55kW 0,75HP L 237mm rotation direction right capacitor 12,5µF OLYMPIA

spare parts for 500475

	Vare nr.	365014	Ref. No.	—
				operating capacitor capacity 12,5µF 400V
	Vare nr.	510693	Ref. No.	N/A
				mechanical shaft seal for shaft ø 12 mm
	Vare nr.	521161	Ref. No.	N/A
				pump cover OLYMPIA inlet ø 50 mm outlet ø 48/31mm
	Vare nr.	521162	Ref. No.	N/A
				impellor ø 106 mm H 22 mm pump type T75
	Vare nr.	521727	Ref. No.	N/A
				pump cover gasket EPDM thickness 1,78 mm







1

Vare nr.	499260	Ref. No.	A.4.5/2.6
description	pump inlet ø 60mm outlet ø 48mm type A.4.5/2.6 220-240/380-415V 50Hz 3 phase 1,12kW 1,5HP L 310mm rotation direction right OLYMPIA		
spare parts for	499260		
	Vare nr.	510693	Ref. No. N/A
	mechanical shaft seal for shaft ø 12 mm		
	Vare nr.	521175	Ref. No. N/A
	pump cover OLYMPIA inlet ø 60 mm outlet ø 48 mm		
	Vare nr.	521262	Ref. No. N/A
	impellor ø 102 mm H 19 mm rotation direction right		
	Vare nr.	521727	Ref. No. N/A
	pump cover gasket EPDM thickness 1,78 mm		



1

Vare nr.	500529	Ref. No.	T12
description	pump inlet ø 60mm outlet ø 48mm type T12 230V 50Hz 1 phase 0,88kW 1,2HP L 270mm rotation direction right capacitor 16µF auxiliary pressure connection 10mm supporting pressure open OLYMPIA		
spare parts for	500529		
	Vare nr.	365021	Ref. No. —
	operating capacitor capacity 16µF 425V		

spare parts for 500529			
	Vare nr.	510693	Ref. No. N/A
	mechanical shaft seal for shaft ø 12 mm		
	Vare nr.	521010	Ref. No. N/A
	impellor ø 98 mm H 12 mm M10L blades 8		
	Vare nr.	521559	Ref. No. N/A
	pump cover OLYMPIA inlet ø 60 mm outlet ø 48 mm		
	Vare nr.	521727	Ref. No. N/A
	pump cover gasket EPDM thickness 1,78 mm		



1

Vare nr.	500530	Ref. No.	T15
description	pump inlet ø 60mm outlet ø 48mm type T15 230V 50Hz 1 phase 1,1kW 1,5HP L 305mm rotation direction right OLYMPIA		
spare parts for	500530		
	Vare nr.	365021	Ref. No. —
	operating capacitor capacity 16µF 425V		
	Vare nr.	510693	Ref. No. N/A
	mechanical shaft seal for shaft ø 12 mm		
	Vare nr.	521039	Ref. No. —
	fanwheel cover ID ø 156mm ED ø 161mm H 76mm		
	Vare nr.	521262	Ref. No. N/A
	impellor ø 102 mm H 19 mm rotation direction right		
	Vare nr.	521559	Ref. No. N/A
	pump cover OLYMPIA inlet ø 60 mm outlet ø 48 mm		
	Vare nr.	521727	Ref. No. N/A
	pump cover gasket EPDM thickness 1,78 mm		



1

Vare nr.	499291	Ref. No.	T.15 (6501)
description	pump inlet ø 60mm outlet ø 48mm type T15 230V 50Hz 1 phase 1,1kW L 310mm rotation direction right capacitor 16µF OLYMPIA		
spare parts for	499291		
	Vare nr.	365021	Ref. No. —
	operating capacitor capacity 16µF 425V		
	Vare nr.	510693	Ref. No. N/A
	mechanical shaft seal for shaft ø 12 mm		
	Vare nr.	521162	Ref. No. N/A
	impellor ø 106 mm H 22 mm pump type T75		
	Vare nr.	521175	Ref. No. N/A
	pump cover OLYMPIA inlet ø 60 mm outlet ø 48 mm		
	Vare nr.	521727	Ref. No. N/A
	pump cover gasket EPDM thickness 1,78 mm		

spare parts for	500526		
	Vare nr.	510693	Ref. No. N/A
	mechanical shaft seal for shaft ø 12 mm		
	Vare nr.	521260	Ref. No. N/A
	impellor ø 90 mm H 12 mm M10L type B		
	Vare nr.	521559	Ref. No. N/A
	pump cover OLYMPIA inlet ø 60 mm outlet ø 48 mm		
	Vare nr.	521727	Ref. No. N/A
	pump cover gasket EPDM thickness 1,78 mm		



1

Vare nr.	499338	Ref. No.	MEC71.T120SX
description	pump inlet ø 62mm outlet ø 50mm type MEC71.T120SX 220-240/380-415V 50Hz 3 phase 0,88kW 1,2HP L 310mm rotation direction right OLYMPIA		
spare parts for	499338		
	Vare nr.	510693	Ref. No. N/A
	mechanical shaft seal for shaft ø 12 mm		
	Vare nr.	521152	Ref. No. N/A
	pump cover OLYMPIA inlet 62 ø 190 mm		
	Vare nr.	521153	Ref. No. N/A
	pump casing OLYMPIA outlet ø 52 mm		
	Vare nr.	521154	Ref. No. N/A
	O-ring ID ø 152,7 mm thickness 2,62 mm EPDM		







1

Vare nr.	500526	Ref. No.	T75
description	pump inlet ø 60mm outlet ø 48mm type T75 230V 50Hz 1 phase 0,55kW 0,75HP L 250mm rotation direction right capacitor 12,5µF auxiliary pressure connection 10mm supporting pressure open OLYMPIA		
spare parts for	500526		
	Vare nr.	365014	Ref. No. —
	operating capacitor capacity 12,5µF 400V		





1





Vare nr.	499259	Ref. No.	MEC71.T1200X
description	pump inlet ø 62mm outlet ø 52mm type MEC.T120DX 220-240/380-415V 50Hz 3 phase 0,89kW 1,2HP L 310mm rotation direction left OLYMPIA		
spare parts for	499259		
	Vare nr.	510693	Ref. No. N/A
	mechanical shaft seal for shaft ø 12 mm		
	Vare nr.	521152	Ref. No. N/A
	pump cover OLYMPIA inlet 62 ø 190 mm		
	Vare nr.	521153	Ref. No. N/A
	pump casing OLYMPIA outlet ø 52 mm		
	Vare nr.	521154	Ref. No. N/A
	O-ring ID ø 152,7 mm thickness 2,62 mm EPDM		
	Vare nr.	521172	Ref. No. N/A
	impellor ø 107 mm H 28 mm pump type MEC.T120DX		



1



Vare nr.	499226	Ref. No.	MEC80.T200SX
description	pump inlet ø 62mm outlet ø 52mm type MEC80.T200SX 230/400V 50Hz 3 phase 1,5kW 2HP L 340mm rotation direction right OLYMPIA		
spare parts for	499226		
	Vare nr.	510693	Ref. No. N/A
	mechanical shaft seal for shaft ø 12 mm		
	Vare nr.	521152	Ref. No. N/A
	pump cover OLYMPIA inlet 62 ø 190 mm		

spare parts for 499226





	Vare nr.	521153	Ref. No. N/A
	pump casing OLYMPIA outlet ø 52 mm		
	Vare nr.	521154	Ref. No. N/A
	O-ring ID ø 152,7 mm thickness 2,62 mm EPDM		
	Vare nr.	521155	Ref. No. N/A
	impellor ø 117 mm H 31 mm pump type OLYMPIA		
accessories for	499226		
	Vare nr.	542157	Ref. No. —
	bracket for wash pump L 267mm W 132mm H 43mm		



1

Vare nr.	499290	Ref. No.	8801
description	pump inlet ø 63mm outlet ø 51mm type MEC80.T220SX 380-415V 50Hz 3 phase 1,64kW 2,2HP L 330mm rotation direction right OLYMPIA		
spare parts for	499290		
	Vare nr.	510693	Ref. No. N/A
	mechanical shaft seal for shaft ø 12 mm		
	Vare nr.	517650	Ref. No. N/A
	impellor ø 107 mm H 31 mm pump type MEC80.T220SX		
	Vare nr.	521152	Ref. No. N/A
	pump cover OLYMPIA inlet 62 ø 190 mm		
	Vare nr.	521153	Ref. No. N/A
	pump casing OLYMPIA outlet ø 52 mm		
	Vare nr.	521154	Ref. No. N/A
	O-ring ID ø 152,7 mm thickness 2,62 mm EPDM		



1			
Vare nr.	500535	Ref. No.	T70
description	pump inlet ø outlet ø 27mm type T70 230V 50Hz 1 phase 0,3kW 0,4HP L 130mm rotation direction right capacitor 6,3µF OLYMPIA		
spare parts for	500535		
	Vare nr.	365012	Ref. No. —
	operating capacitor capacity 6,3µF 450V		
	Vare nr.	510556	Ref. No. N/A
	O-ring EPDM thickness 1,78 mm ID ø 94,97 mm		
	Vare nr.	510693	Ref. No. N/A
	mechanical shaft seal for shaft ø 12 mm		
	Vare nr.	521254	Ref. No. N/A
	impellor ø 81 mm H 11 mm thread M8L shaft ø 12 mm		

spare parts and accessories

mechanical shaft seals



1			
Vare nr.	510693	Ref. No.	N/A
description	mechanical shaft seal for shaft ø 12mm slide ring ext. ø 24mm slide ring H 15,5mm slide ring int. ø 11mm counter ring mounting ø 24mm height counter ring 8mm counter ring int. ø 14mm		

impellers



1			
Vare nr.	521262	Ref. No.	N/A
description	impellor ø 102mm H 19mm rotation direction right thread M10L blades 6		



1			
Vare nr.	517368	Ref. No.	N/A
description	impellor ø 102mm H 21mm rotation direction right thread M10L suitable for Dihr blades 8		



1			
Vare nr.	521162	Ref. No.	N/A
description	impellor ø 106mm H 22mm pump type T75 thread M10L		

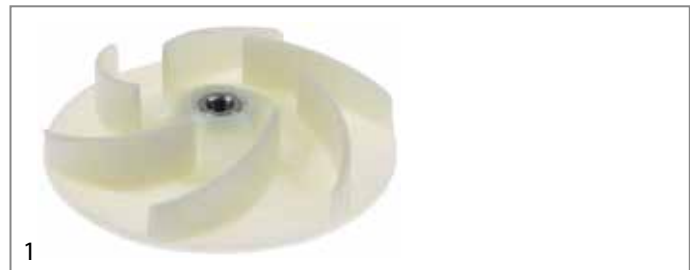

1			
Vare nr.	521172	Ref. No.	N/A
description	impellor ø 107mm H 28mm pump type MEC.T120DX thread M8R		



1

Vare nr.	517650	Ref. No.	N/A
description	impellor ø 107mm H 31mm pump type MEC80.T220SX shaft intake ø 12mm rotation direction right thread M8L blades 6		



1

Vare nr.	521155	Ref. No.	N/A
description	impellor ø 117mm H 31mm pump type OLYMPIA thread M8L blades 6		



1

Vare nr.	521174	Ref. No.	N/A
description	impellor ø 60mm H 16mm pump type L63.T20SX shaft ø 12mm shaft length 8mm		



1

Vare nr.	521164	Ref. No.	N/A
description	impellor ø 64mm H 15mm pump type L63.T19 thread M7L shaft ø 12mm shaft length 30mm		



1

Vare nr.	521169	Ref. No.	N/A
description	impellor ø 64mm H 15mm pump type T.19DX thread M7R shaft ø 12mm shaft length 30mm		



1

Vare nr.	521151	Ref. No.	N/A
description	impellor ø 71mm H 19mm pump type OLYMPIA thread M10R shaft ø 12mm shaft length 8mm		



1

Vare nr.	521256	Ref. No.	N/A
description	impellor ø 74mm H 14mm thread M10L shaft ø 12mm shaft length 7,5mm blades 8		



1

Vare nr.	521171	Ref. No.	N/A
description	impellor ø 74mm H 16mm pump type L63.T40 thread M10L		



1

Vare nr.	510249	Ref. No.	N/A
description	impellor ø 74mm H 19mm pump type T25 rotation direction left thread M10R shaft ø 12mm shaft length 8mm blades 6		



1

Vare nr.	521157	Ref. No.	N/A
description	impellor ø 82mm H 22mm thread M10L		



1

Vare nr.	509001	Ref. No.	N/A
description	impellor ø 75mm H 15mm pump type type C rotation direction left thread M6R shaft ø 11/12mm shaft length 25mm blades 4		



1

Vare nr.	509007	Ref. No.	N/A
description	impellor ø 85mm H 20mm rotation direction left thread M10R shaft ø 12mm shaft length 7,5mm blades 12		



1

Vare nr.	521258	Ref. No.	N/A
description	impellor ø 80mm H 13mm thread M10R shaft ø 12mm shaft length 7,5mm blades 6		



1

Vare nr.	521260	Ref. No.	N/A
description	impellor ø 90mm H 12mm M10L type B		



1

Vare nr.	521254	Ref. No.	N/A
description	impellor ø 81mm H 11mm thread M8L shaft ø 12mm shaft length 28mm blades 6		



1

Vare nr.	510615	Ref. No.	N/A
description	impellor ø 90mm H 22mm rotation direction right thread M10L blades 4		



1

Vare nr.	521166	Ref. No.	N/A
description	impellor ø 90mm H 9mm pump type R63.T33 PRS thread M10R shaft ø 12mm shaft length 8mm		



1

Vare nr.	521259	Ref. No.	N/A
description	impellor ø 94mm H 11mm rotation direction left thread M10R blades 6		



1

Vare nr.	521160	Ref. No.	N/A
description	impellor ø 97mm H 22mm thread M10L		



1

Vare nr.	521010	Ref. No.	N/A
description	impellor ø 98mm H 12mm M10L blades 8		

pump covers



1

Vare nr.	521178	Ref. No.	N/A
description	pump casing OLYMPIA outlet ø 30/24mm pump type T80		



1

Vare nr.	521153	Ref. No.	N/A
description	pump casing OLYMPIA outlet ø 52mm		



1

Vare nr.	521554	Ref. No.	N/A
description	pump cover OLYMPIA inlet 1" ø 90mm ID ø 66mm inner hight 5mm		



1

Vare nr.	509003	Ref. No.	N/A	
description	pump cover OLYMPIA inlet 1" outlet ø 28mm pump type T60			
accessories for	509003			
	Vare nr.	528800	Ref. No.	N/A
	O-ring EPDM thickness 2,62 mm ID ø 75,87 mm			



1

Vare nr.	521159	Ref. No.	N/A
description	pump cover OLYMPIA inlet 30 inlet ø 30mm auxiliary pressure connection 10mm pump type L71.T730_30		



1

Vare nr.	521168	Ref. No.	N/A
description	pump cover OLYMPIA inlet ø 14mm outlet ø 30mm pump type T.19DX		



1

Vare nr.	521158	Ref. No.	N/A
description	pump cover OLYMPIA inlet 45 inlet ø 40mm pump type MEC71.T75SX		



1

Vare nr.	521165	Ref. No.	N/A
description	pump cover OLYMPIA inlet ø 15mm outlet ø 13mm pump type R63.T33 PRS		



1

Vare nr.	521152	Ref. No.	N/A
description	pump cover OLYMPIA inlet 62 ø 190mm		



1

Vare nr.	521163	Ref. No.	N/A
description	pump cover OLYMPIA inlet ø 28mm outlet ø 26mm pump type L63.T19		



1

Vare nr.	521176	Ref. No.	N/A
description	pump cover OLYMPIA inlet ø 14mm outlet ø 28mm pump type T 4		



1

Vare nr.	510248	Ref. No.	N/A
description	pump cover OLYMPIA inlet ø 28mm outlet ø 28mm auxiliary pressure connection 10,5mm supporting pressure closed turn direction left ø 100mm ID ø 83mm inner height 25mm		



1

Vare nr.	521167	Ref. No.	N/A
description	pump cover OLYMPIA inlet ø 14mm outlet ø 30/30mm ID ø 94mm		



1

Vare nr.	521555	Ref. No.	N/A
description	pump cover OLYMPIA inlet ø 29mm outlet ø 28mm ø 132mm ID ø 123mm inner height 18mm		



1

Vare nr.	521552	Ref. No.	N/A
description	pump cover OLYMPIA inlet ø 32mm outlet ø 30/24mm ø 103mm ID ø 93mm		



1

Vare nr.	521173	Ref. No.	N/A
description	pump cover OLYMPIA inlet ø 33mm outlet ø 30mm auxiliary pressure connection 10mm pump type L63.T20SX		



1

Vare nr.	521551	Ref. No.	N/A
description	pump cover OLYMPIA inlet ø 33mm outlet ø 30mm outlet 2 ø 28 turn direction left ø 103mm ID ø 93mm inner height 30mm		



1

Vare nr.	521553	Ref. No.	N/A
description	pump cover OLYMPIA inlet ø 33mm outlet ø 30mm turn direction left ø 103mm ID ø 93mm inner height 25mm		



1

Vare nr.	521550	Ref. No.	N/A
description	pump cover OLYMPIA inlet ø 44mm supporting pressure M8 supporting pressure closed ø 103mm ID ø 93mm		



1

Vare nr.	510512	Ref. No.	N/A
description	pump cover OLYMPIA inlet ø 45mm outlet ø 31mm outlet 2 ø 24 turn direction right ø 130mm ID ø 124mm inner height 20mm		



1

Vare nr.	521556	Ref. No.	N/A
description	pump cover OLYMPIA inlet ø 50mm outlet ø 30mm outlet 2 ø 30 auxiliary pressure connection 10mm supporting pressure open turn direction right ø 130mm ID ø 124mm inner height 20mm		



1

Vare nr.	521569	Ref. No.	N/A
description	pump cover OLYMPIA inlet ø 50mm outlet ø 31mm auxiliary pressure connection 10mm supporting pressure closed ø 130mm ID ø 124mm inner high 20mm		



1

Vare nr.	521175	Ref. No.	N/A
description	pump cover OLYMPIA inlet ø 60mm outlet ø 48mm outlet 2 ø 31 auxiliary pressure connection 10mm		



1

Vare nr.	521156	Ref. No.	N/A
description	pump cover OLYMPIA inlet ø 50mm outlet ø 40mm pump type L71T5_5040		



1

Vare nr.	521559	Ref. No.	N/A
description	pump cover OLYMPIA inlet ø 60mm outlet ø 48mm outlet 2 ø 31 auxiliary pressure connection 10mm supporting pressure open turn direction right ø 170mm ID ø 150mm inner high 22mm		



1

Vare nr.	521161	Ref. No.	N/A
description	pump cover OLYMPIA inlet ø 50mm outlet ø 48/31mm auxiliary pressure connection 10mm pump type T75		



1

Vare nr.	521170	Ref. No.	N/A
description	pump cover OLYMPIA outlet ø 30mm auxiliary pressure connection 11mm pump type L63.T19		



1

Vare nr.	521065	Ref. No.	N/A
description	pump cover OLYMPIA inlet ø 50mm outlet ø 48mm pump type T15 turn direction right ø 170mm ID ø 150mm inner high 34mm		

pump cover gaskets

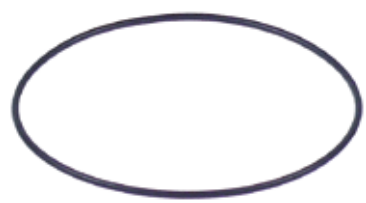



1

Vare nr.	521724	Ref. No.	N/A
description	O-ring EPDM thickness 1,78mm ID ø 72,75mm Qty 1 pcs		





			
1			
Vare nr.	525022	Ref. No.	N/A
description	O-ring EPDM thickness 1,78mm ID ø 75,92mm Qty 1 pcs		

			
1			
Vare nr.	510556	Ref. No.	N/A
description	O-ring EPDM thickness 1,78mm ID ø 94,97mm Qty 1 pcs pump type T110		

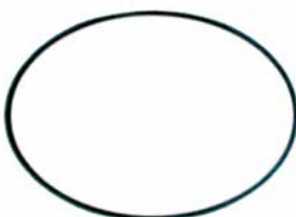
			
1			
Vare nr.	528800	Ref. No.	N/A
description	O-ring EPDM thickness 2,62mm ID ø 75,87mm Qty 1 pcs		

			
1			
Vare nr.	510554	Ref. No.	N/A
description	O-ring EPDM thickness 2mm ID ø 120mm Qty 1 pcs		

			
1			
Vare nr.	521154	Ref. No.	N/A
description	O-ring ID ø 152,7mm thickness 2,62mm EPDM Qty 1 pcs		

			
1			
Vare nr.	521727	Ref. No.	N/A
description	pump cover gasket EPDM thickness 1,78mm ID ø 145mm Qty 1 pcs		

			
1			
Vare nr.	521703	Ref. No.	N/A
description	pump cover gasket EPDM thickness 2,5mm ID ø 75mm Qty 1 pcs		

			
1			
Vare nr.	521726	Ref. No.	N/A
description	pump cover gasket EPDM thickness 2mm ID ø 120mm Qty 1 pcs		

			
1			
Vare nr.	521723	Ref. No.	N/A
description	pump cover gasket EPDM thickness 2mm ID ø 90mm Qty 1 pcs		